

*Friendly Specialist*  
**SERVICE**



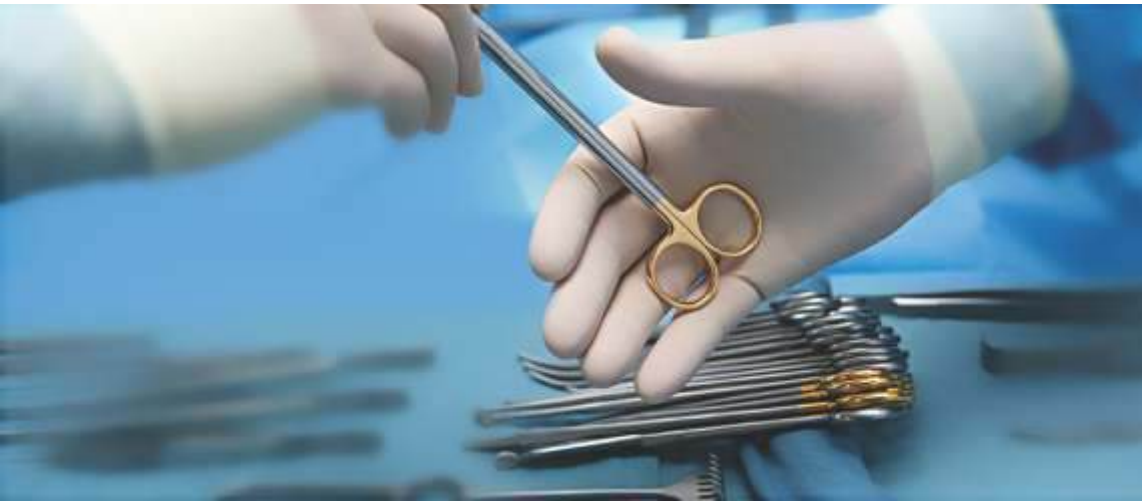
Professional  
**DENTAL**  
Instruments  
Range



**QUIRKY INSTRUMENTS**

PREMIUM QUALITY INSTRUMENTS

[info@quirkyinstruments.com](mailto:info@quirkyinstruments.com) | [www.quirkyinstruments.com](http://www.quirkyinstruments.com)



## About Us

**QUIRKY INSTRUMENTS** pride itself to be a company giving utmost assurance towards achieving our customer's trust. For us customer satisfaction comes first before any other desired organizational goals for which companies strive hard to accomplish.

**Quirky Dental** since formed we have witnessed rapid but consistent growth in our customer base and business volumes. We pride ourselves to be a reliable brand name having presence in three continents across the world. This has been achieved through our committed efforts to serve the requirements of our customers in best possible manner.

Through collaboration with surgeons, clinical technicians and nurses around the world, we identify surgical needs and advance them into effective and safe products.

## Special or Custom Designed Instruments

**QUIRKY INSTRUMENTS** welcome the opportunity to manufacture instruments that are currently available, but are desired in an alternative tip/-handle selection or belong to special school of pattern. We produce custom designed instruments on your request as well. Please send us an actual sample and/or a detailed written description that includes all dimensions and measurements.

## Quirky Dental Instruments Guarantee

Any product that fails within the expected lifetime of an instrument as a result of material defect or poor workmanship will be repaired or replaced at no charge. As a service, we also offer sharpening, repair or reworking of instruments. The **QUIRKY INSTRUMENTS** customer service will be pleased to support and consult you in this regard.

We cannot be held responsible for the performance or replacement of any instrument that has been tampered with, modified or refitted in any manner.

## How to Place an Order

Instruments can only be ordered through our authorized dealer. Your surgical dealer will take your order and ship the products to you. If you have questions prior to placing an order or if you would like to place an order for any of our products, please contact us at [INFO@QUIRKYINSTRUMENTS.COM](mailto:INFO@QUIRKYINSTRUMENTS.COM)

01



Extracting Forceps

Page 01-20

02



Orthodontic  
Instruments

Page 21-35

03



Elevators

Page 36-42

04



Scissors

Page 43-47

05



Tweezers, Forceps  
& Needle Holders







Page 48-56

06



Implantology Instruments  
& Mouth Gags

Page 57-77


Page 78 - 118	Mirror Handles, Scalers & Knives		07
Page 119 - 133	Crown, Ligature & Laboratory Instruments		08
Page 134 - 138	Dental Syringes		09
Page 139 - 143	Impression Trays		10
Page 144 - 154	Hollow Ware		11
Page 155 - 157	Articulators		12



# QUIRKY INSTRUMENTS

PREMIUM QUALITY INSTRUMENTS

 Shahab Pura Road, Sialkot - 51310 Pakistan.

 +92-341-4059033

 [info@quirkyinstruments.com](mailto:info@quirkyinstruments.com)

 [www.quirkyinstruments.com](http://www.quirkyinstruments.com)





01

Page 1-20

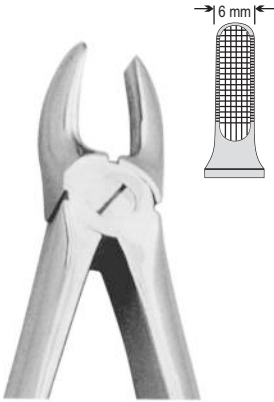
## Extraction / Estrazione

Extracting Forceps

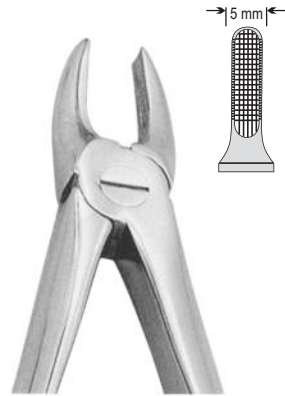
Root Elevators

Luxators

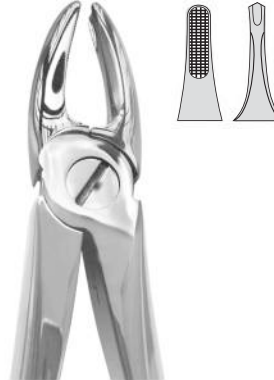
Periotomes



No. 1  
**QI-01-001**  
Upper Centrals &  
Canines / Cuspids



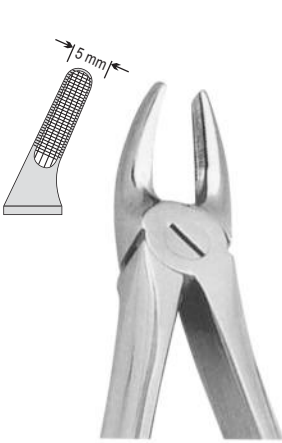
No. 2  
**QI-01-002**  
Upper Laterals &  
Canines / Cuspids



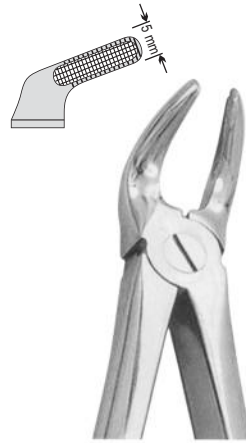
No. 3  
**QI-01-003**  
Upper Incisors  
& Canines



No. 4  
**QI-01-004**  
Lower Incisors  
& Cuspids



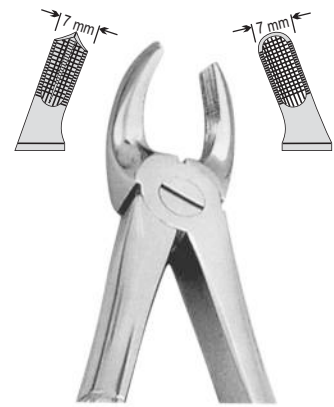
No. 7  
**QI-01-005**  
Upper Premolars / Bicuspids



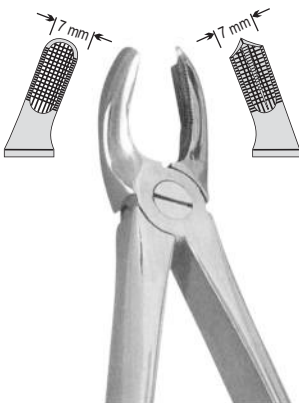
No. 8  
**QI-01-006**  
Lower Premolars / Bicuspids



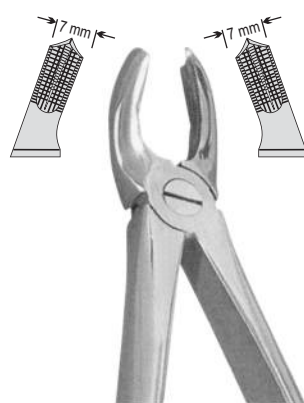
No. 13  
**QI-01-007**  
Lower Premolars / Bicuspids



No. 17  
**QI-01-008**  
Upper Molars, Right



No. 18  
**QI-01-009**  
Upper Molars, Left



No. 18A  
**QI-01-010**  
Upper Molars



No. 19  
**QI-01-011**  
Upper Third Molars

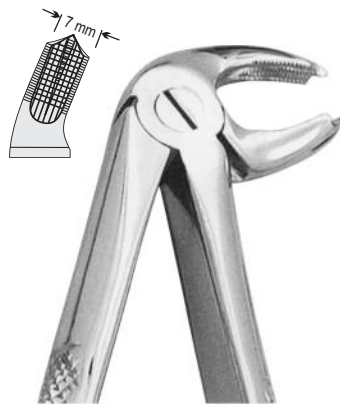


No. 21  
**QI-01-012**  
Lower Molars

EXTRACTION FORCEPS STANDARD ENGLISH PATTERN  
 PINZE PER ESTRAZIONE MODELLO INGLESE STANDARD



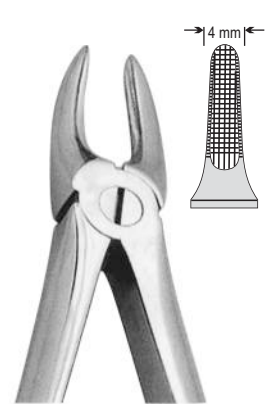
No. 22  
**QI-01-013**  
 Lower Molars



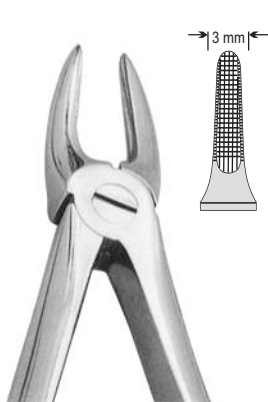
No. 23  
**QI-01-014**  
 Lower Molars  
 Right



No. 24  
**QI-01-015**  
 Lower Molars  
 Left



No. 29  
**QI-01-016**  
 Upper Roots



No. 29N  
**QI-01-017**  
 Upper Roots



No. 30  
**QI-01-018**  
 Upper Roots



No. 31  
**QI-01-019**  
 Lower Roots



No. 32  
**QI-01-020**  
 Lower Molars



No. 33  
**QI-01-021**  
 Lower Roots



No. 33A  
**QI-01-022**  
 Lower Roots

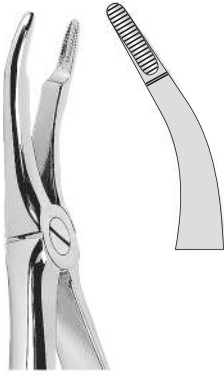


No. 33M  
**QI-01-023**  
 Lower Roots

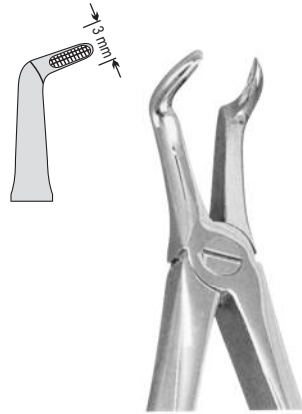


No. 41  
**QI-01-024**  
 Upper Roots

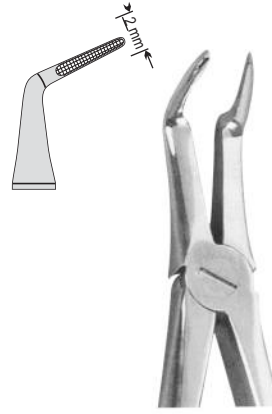




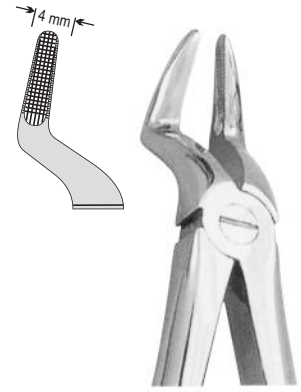
No. 44  
QI-01-025  
Upper Roots



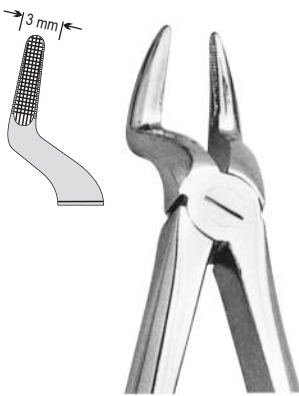
No. 45  
QI-01-026  
Lower Roots



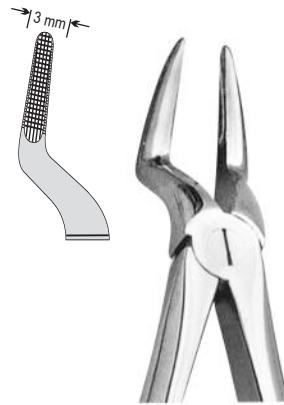
No. 46L  
QI-01-027  
Lower Roots



No. 51  
QI-01-028  
Upper Roots



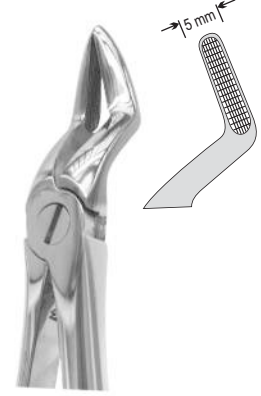
No. 51A  
QI-01-029  
Upper Roots



No. 51M  
QI-01-030  
Upper Roots



No. 52  
QI-01-031  
Upper Roots



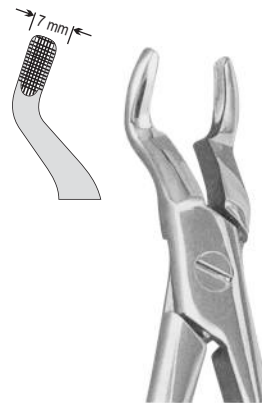
No. 52A  
QI-01-032  
Upper Teeth  
& Resection



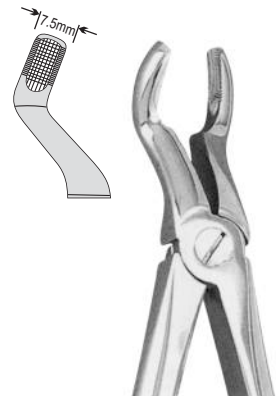
No. 55  
QI-01-033  
For Separating  
Upper Molars



No. 56  
QI-01-034  
For Separating  
Lower Molars



No. 67  
QI-01-035  
Upper Third  
Molars



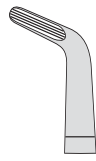
No. 67A  
QI-01-036  
Upper Third  
Molars



**EXTRACTION FORCEPS STANDARD ENGLISH PATTERN**  
**PINZE PER ESTRAZIONE MODELLO INGLESE STANDARD**



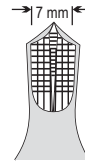
No. 68  
**QI-01-037**  
Lower Roots



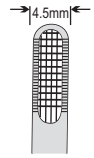
No. 68A  
**QI-01-038**  
Lower Roots



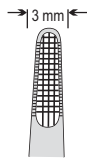
No. 73  
**QI-01-039**  
Lower Molars



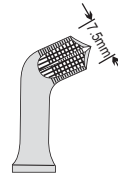
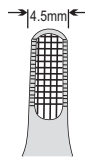
No. 74  
**QI-01-040**  
Lower Roots



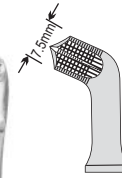
No. 74N  
**QI-01-041**  
Lower Roots



No. 75  
**QI-01-042**  
Lower Premolars / Bicuspid



No. 79  
**QI-01-043**  
Lower Third Molars



No. 79A  
**QI-01-044**  
Lower Third Molars



No. 86A  
**QI-01-045**  
Lower Molars



No. 86C  
**QI-01-046**  
Lower Molars



No. 87  
**QI-01-047**  
Lower Molars



No. 89  
**QI-01-048**  
Right Upper Molars



No. 90  
**QI-01-049**  
Left Upper Molars



No. 91  
**QI-01-050**  
For Separating  
Lower Molars



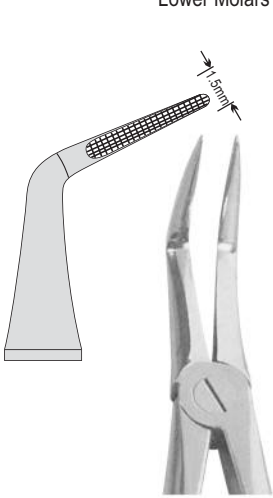
No. 99  
**QI-01-051**  
Lower Molars



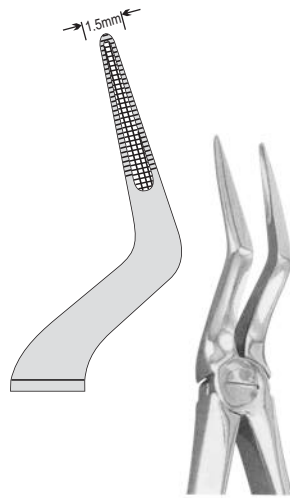
No. 99 1/4  
**QI-01-052**  
Lower Molars



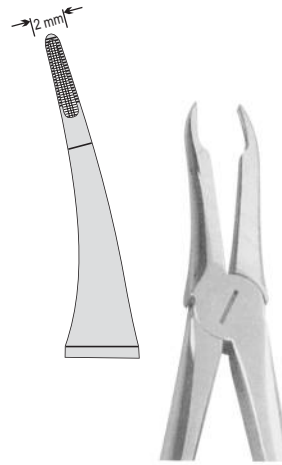
No. 99 1/2  
**QI-01-053**  
Lower Molars



No. 145  
**QI-01-054**  
Very Fine Roots  
Lower



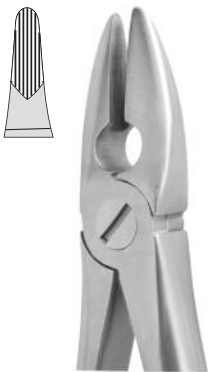
No. 151 1/2  
**QI-01-055**  
Very Fine Roots  
Upper



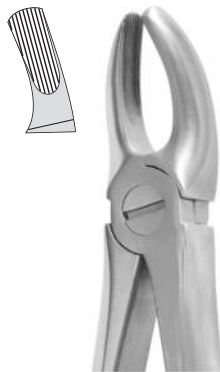
No. 349  
**QI-01-056**  
Very Fine Roots  
Upper



No. 359  
**QI-01-057**  
Very Fine Roots  
Lower



MD 1  
**QI-01-058**  
Incisors, Bicuspid & Roots  
Upper



MD 2  
**QI-01-059**  
Upper Molars

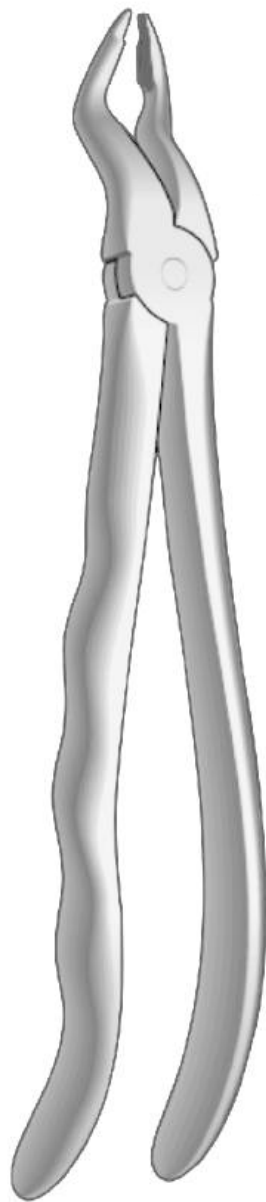


MD 3  
**QI-01-060**  
Incisors, Bicuspid & Roots  
Lower



MD 4  
**QI-01-061**  
Lower Molars

EXTRACTION FORCEPS WITH ANATOMICAL GRIP  
 PINZA PER ESTRAZIONE CON IMPUGNATURA ANATOMICA



No. S-31  
**QI-01-062**  
 Upper Premolars



No. 34  
**QI-01-063**  
 Upper Incisors & Cuspids



No. 35  
**QI-01-064**  
 Upper Incisors & Cuspids,  
 Deep Gripping



No. 79N  
**QI-01-065**  
 Lower Wisdom Teeth



No. 46N  
**QI-01-066**  
 Lower Premolars



Fig. 36  
**QI-01-067**  
 Lower roots  
 Incisors & Cuspids

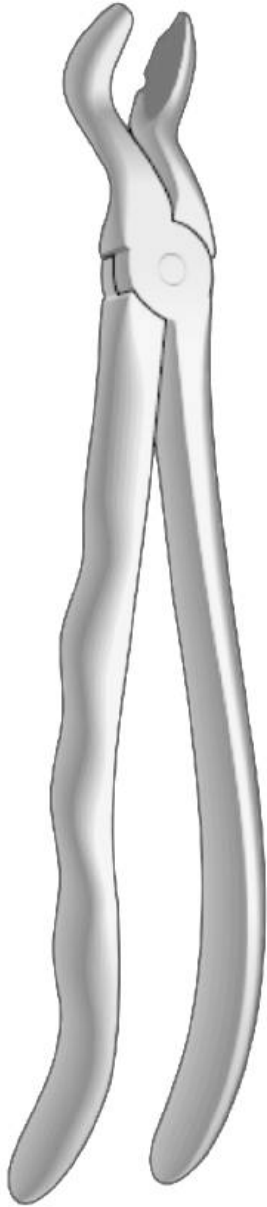


No. 36N  
**QI-01-068**  
 Lower roots  
 Incisors & Cuspids



No. 59  
**QI-01-069**  
 Lower Root Fragments





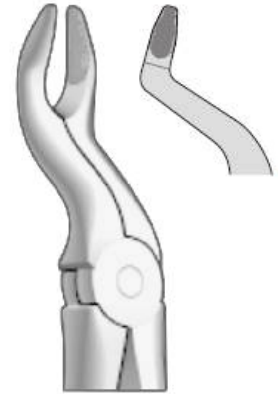
No. 80  
**QI-01-070**  
Felsch  
Upper Wisdom Teeth  
with Retaining Device



No. 67L  
**QI-01-071**  
Upper Molars  
Left



No. 67R  
**QI-01-072**  
Upper Molars  
Right



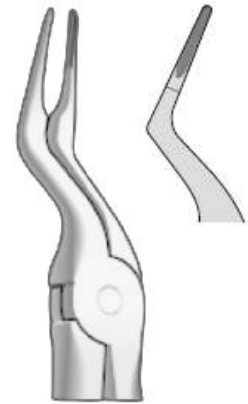
No. 67N  
**QI-01-073**  
Upper Molars



No. 51B  
**QI-01-074**  
Upper Molars



No. 97  
**QI-01-075**  
Upper Root Fragments



No. 97B  
**QI-01-076**  
Upper Root Fragments



No. 122 L  
**QI-01-077**  
Lower Molars & Wisdom Teeth  
Left



No. 122 R  
**QI-01-078**  
Lower Molars & Wisdom Teeth  
Right



No. 133 L  
**QI-01-079**  
Lower Very Fine Roots  
Left



No. 133 R  
**QI-01-080**  
Lower Very Fine Roots  
Right

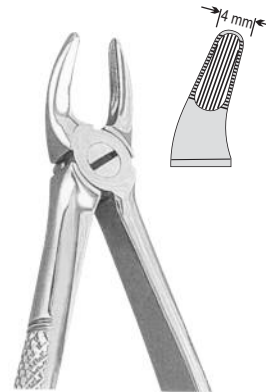
EXTRACTION FORCEPS CHILDREN PATTERN  
PINZE PER ESTRAZIONE MODELLO BAMBINI



No.13S  
QI-01-081  
Lower Premolars



No.22S  
QI-01-082  
Lower Molars



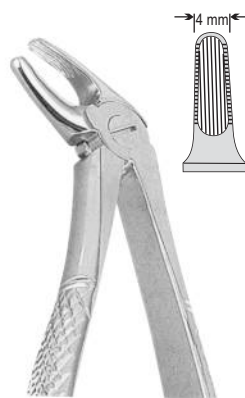
No.30S  
QI-01-083  
Upper Roots



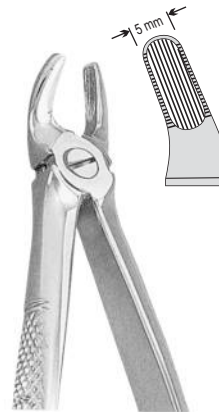
No.33S  
QI-01-084  
Lower Roots



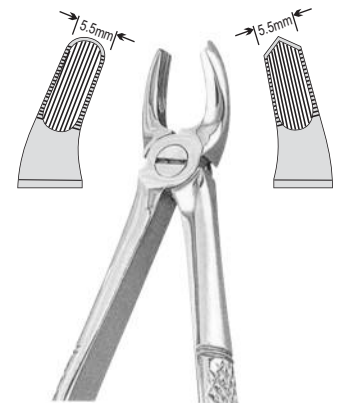
No.37  
QI-01-085  
Upper Incisors



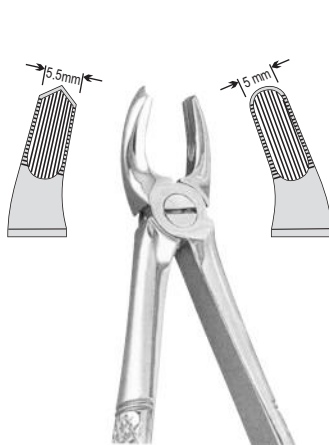
No.38  
QI-01-086  
Lower Incisors and Canines



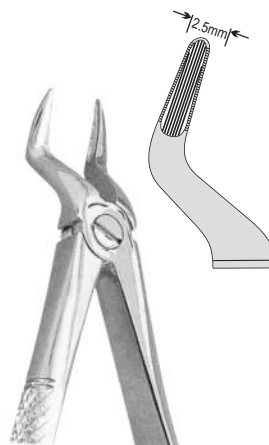
No.39  
QI-01-087  
Upper Molars



No.39L  
QI-01-088  
Upper Molars, left



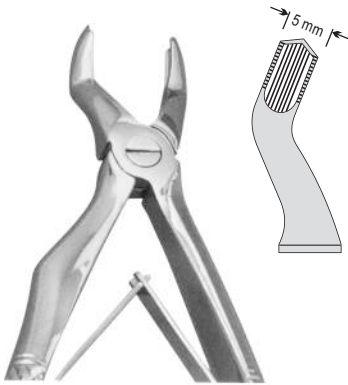
No.39R  
QI-01-089  
Upper Molars, Right



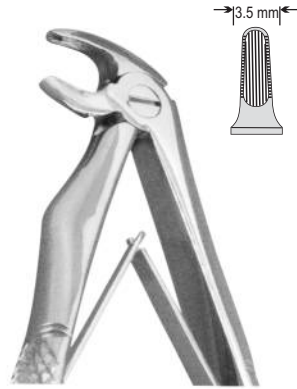
No.51S  
QI-01-090  
Upper Roots



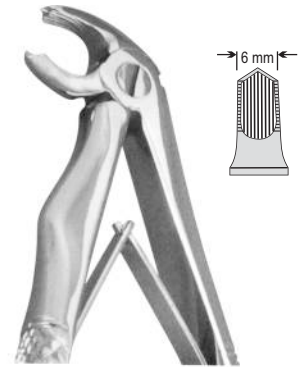
QI-01-091  
Set of 10 pieces



No. 52  
QI-01-092  
Upper Molars



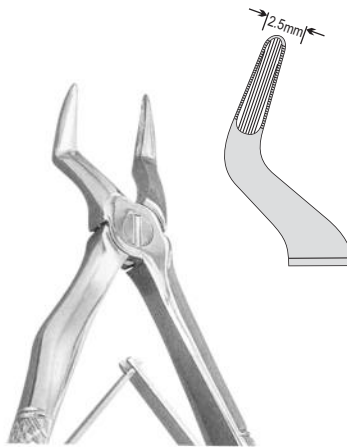
No. 13  
QI-01-093  
Lower Incisors



No. 22  
QI-01-094  
Lower Molars



No. 33  
QI-01-095  
Lower Roots



No.51S  
QI-01-096  
Upper Roots



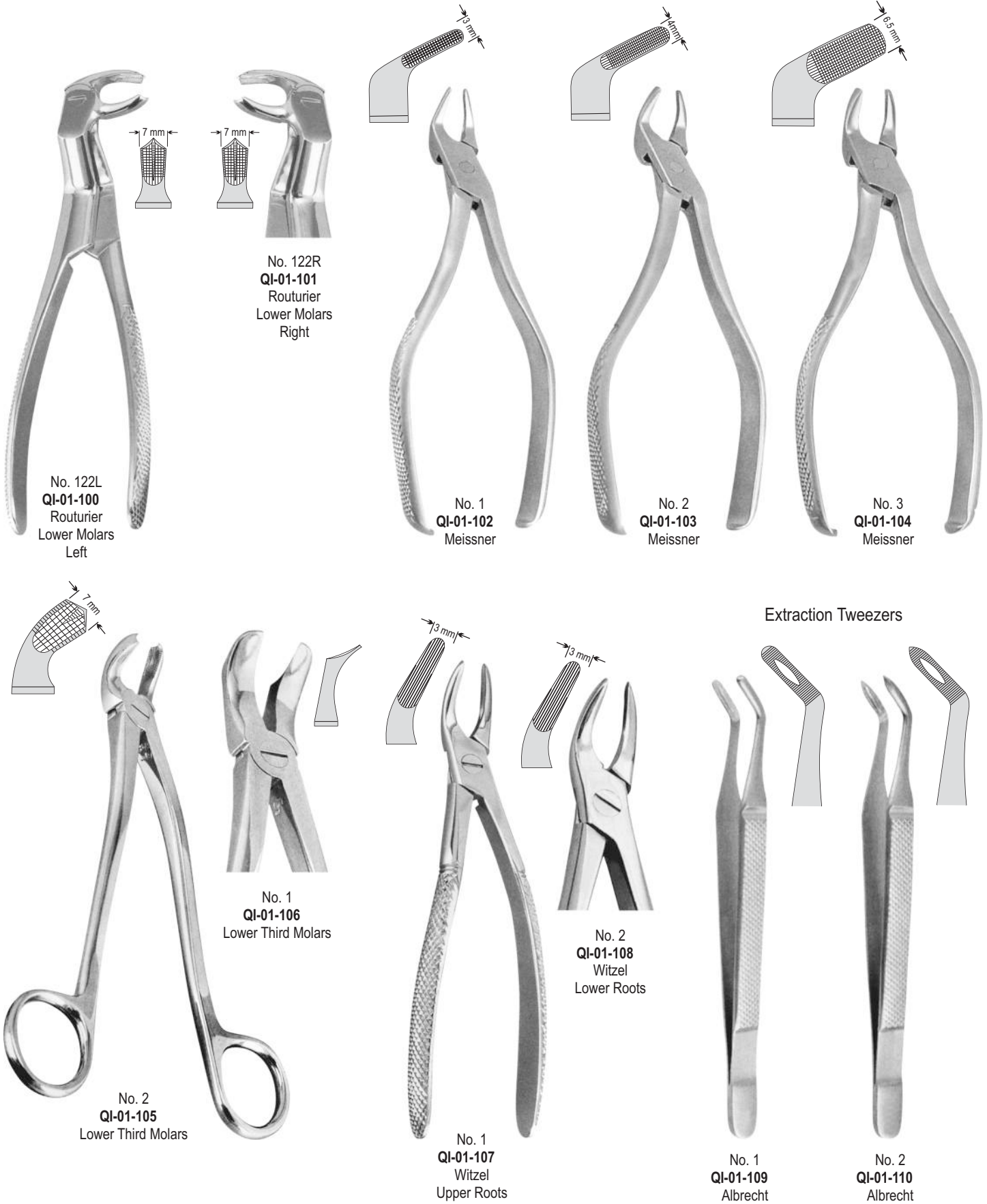
No.137  
QI-01-097  
Upper Incisors



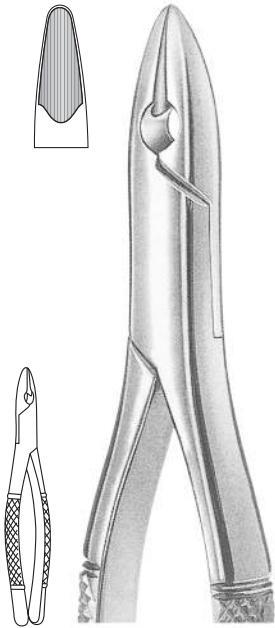
No.7  
QI-01-098  
Upper Premolars



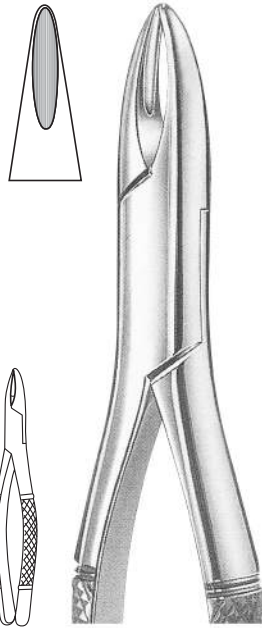
QI-01-099  
Set of 7 pieces







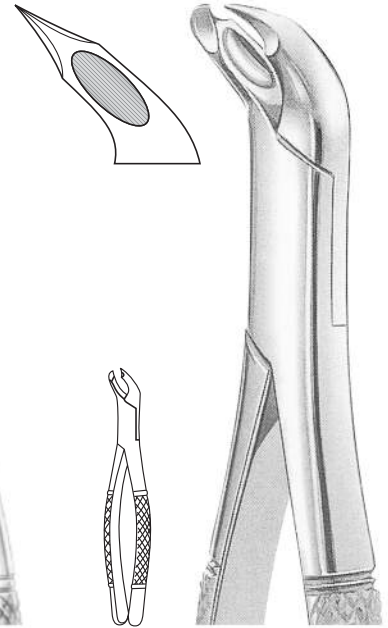
**QI-01-111**  
Upper incisors & cuspids



**QI-01-112**  
Upper incisors



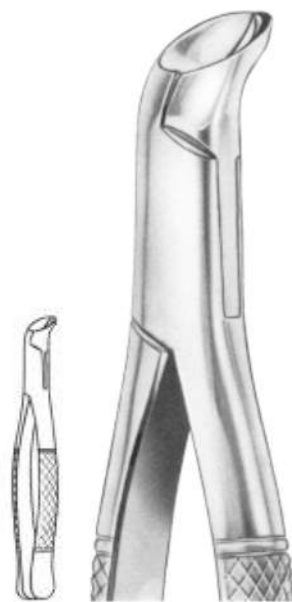
**QI-01-113**  
Upper & Lower Roots



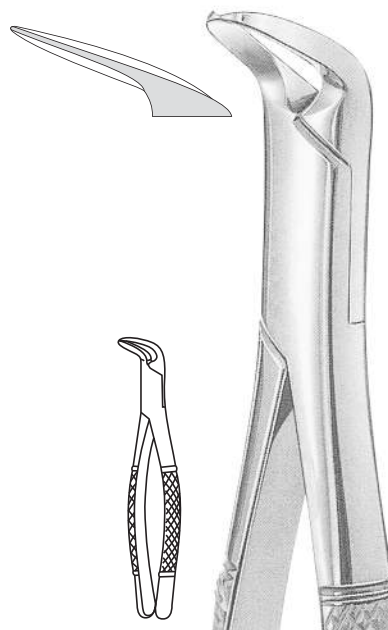
No. 3FS  
**QI-01-114**  
Lower molars



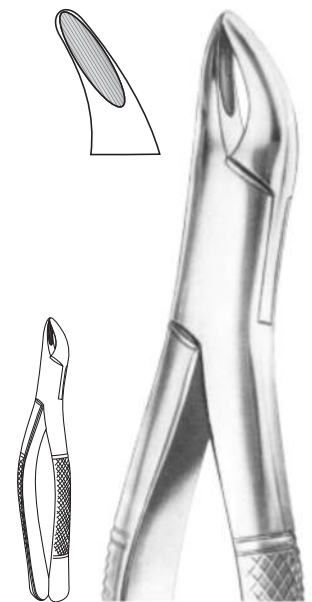
No. 4  
**QI-01-115**  
Upper & Lower Premolars



No. 5  
**QI-01-116**  
Lower third molars

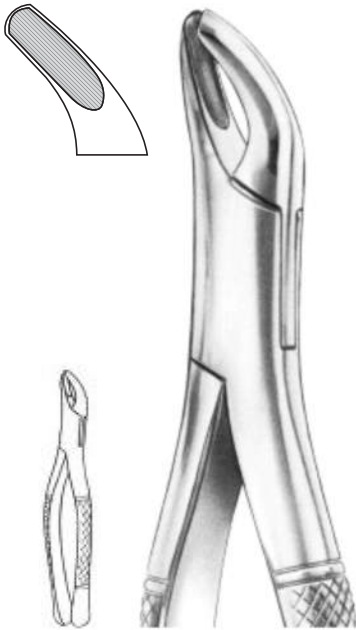


No. 6  
**QI-01-117**  
Splitting & Separating Forceps

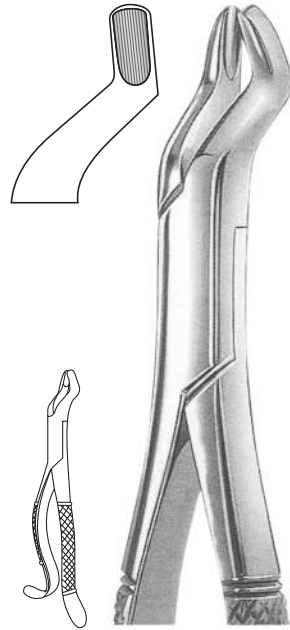


No. 7  
**QI-01-118**  
Upper Roots

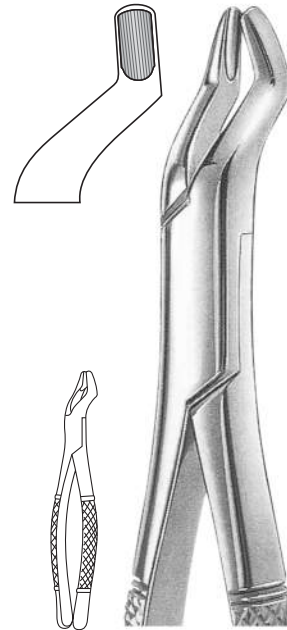
EXTRACTION FOCEPS “AMERICAN PATTERN”  
PINZA PER ESTRAZIONE “MODELLO AMERICANO”



No. 8  
**QI-01-119**  
Upper & Lower third molars



10 H  
**QI-01-120**  
Upper Molars, Hook Handle



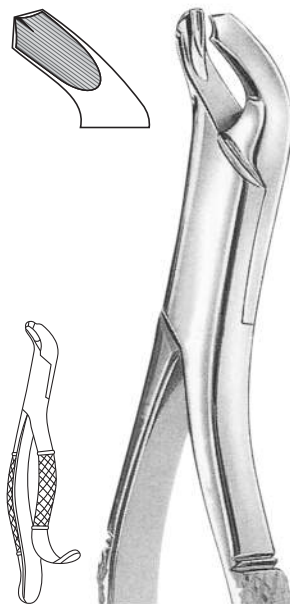
10 S  
**QI-01-121**  
Upper Molars



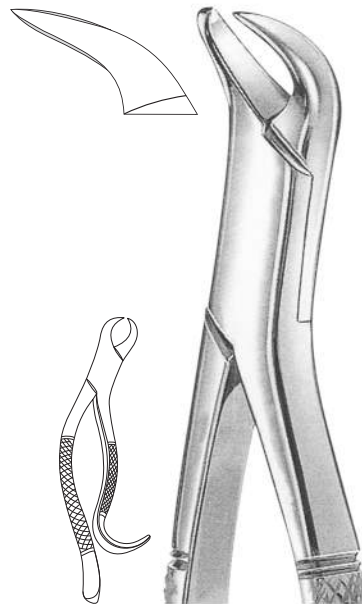
No. 13  
**QI-01-122**  
Upper Incisors



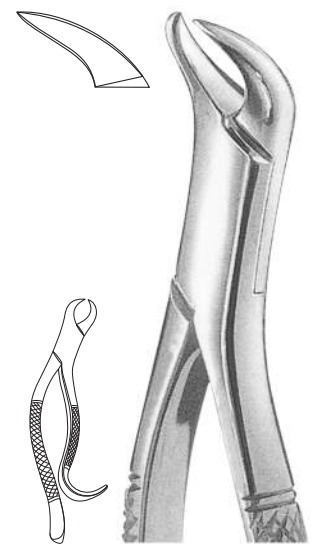
No. 14  
**QI-01-123**  
Lower Incisors



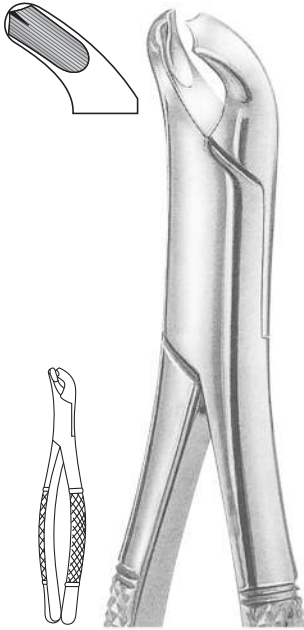
No. 15  
**QI-01-124**  
1st & 2nd Lower Molars



No. 16  
**QI-01-125**  
1st & 2nd Lower Molars



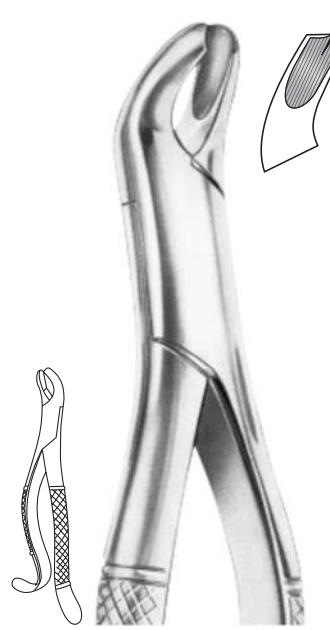
No. 16S  
**QI-01-126**  
Children, Lower Molars



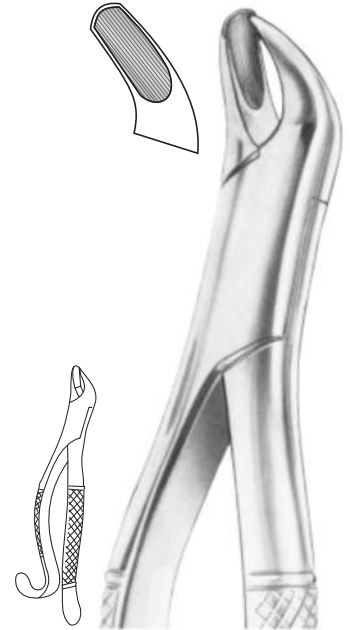
No. 17  
**QI-01-127**  
Gold Plated  
1st & 2nd Lower Molars



18L  
**QI-01-128**  
1st & 2nd Upper Molars, left



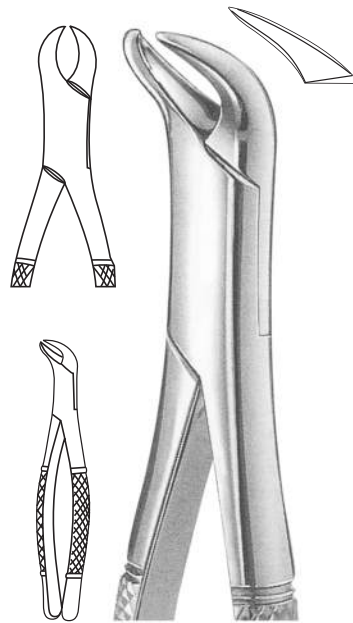
18R  
**QI-01-129**  
1st & 2nd Upper Molars, right



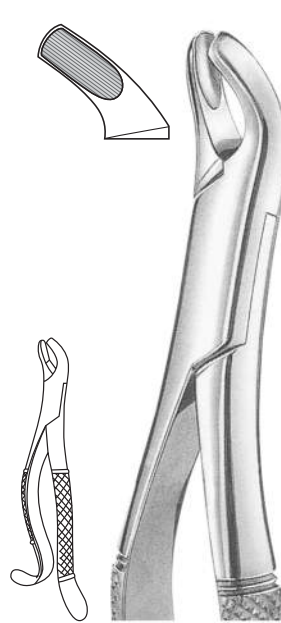
No. 20L  
**QI-01-130**  
Upper Molars left



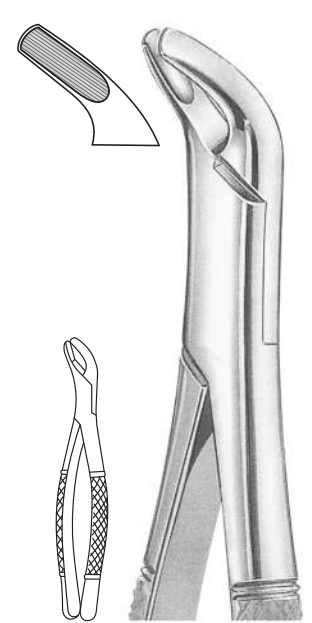
20R  
**QI-01-131**  
Upper Molars right



No. 23  
**QI-01-132**  
Lower Molars

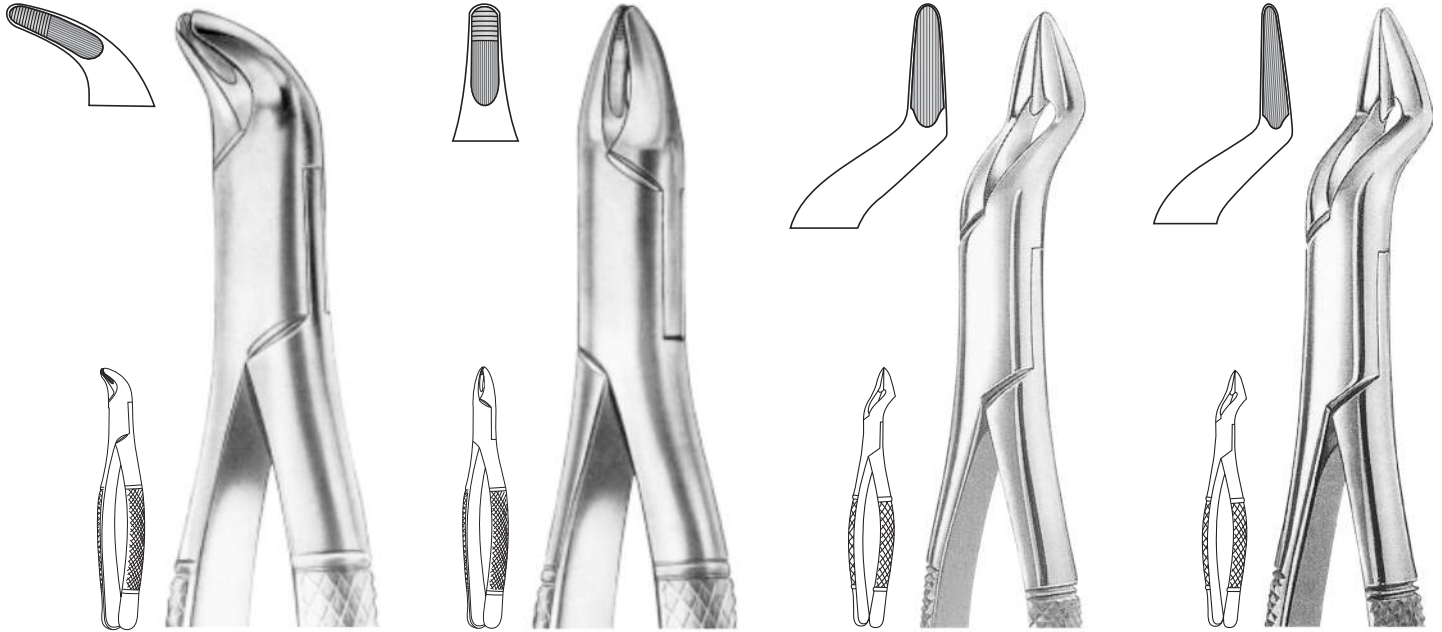


No. 24  
**QI-01-133**  
Upper Molars



No. 27  
**QI-01-134**  
Upper Molars

EXTRACTION FORCEPS "AMERICAN PATTERN"  
 PINZA PER ESTRAZIONE "MODELLO AMERICANO"

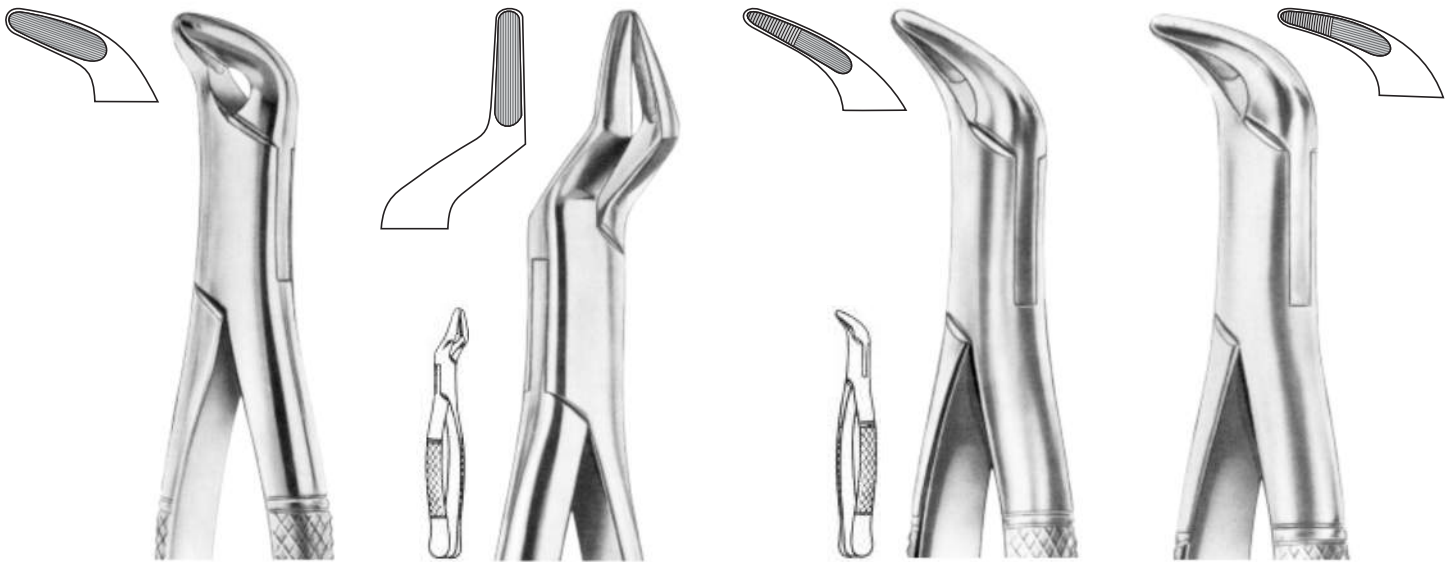


No. 29S  
**QI-01-135**  
 Lower teeth children

No. 30S  
**QI-01-136**  
 Upper teeth children

No. 32  
**QI-01-137**  
 Upper Bicuspids

32A  
**QI-01-138**  
 Upper Bicuspids & Roots



No. 34  
**QI-01-139**  
 Lower Anteriors & Roots

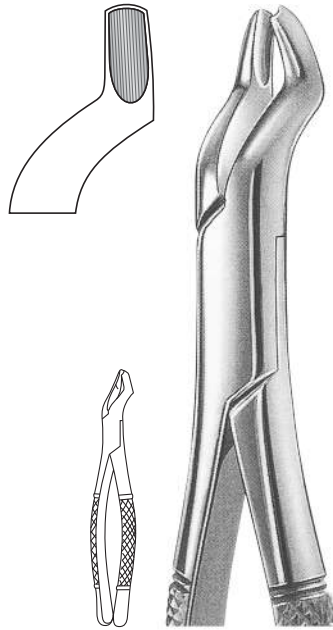
No. 35  
**QI-01-140**  
 Upper Roots

No. 36  
**QI-01-141**  
 Lower Anteriors & Roots

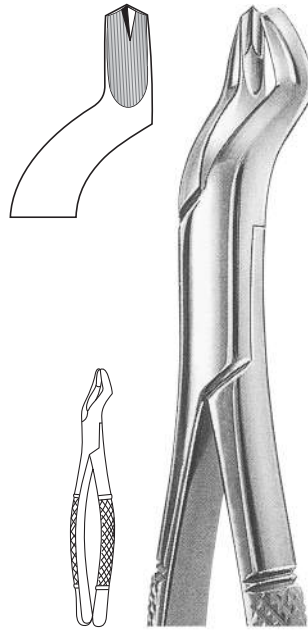
No. 37  
**QI-01-142**  
 Lower Anteriors & Roots



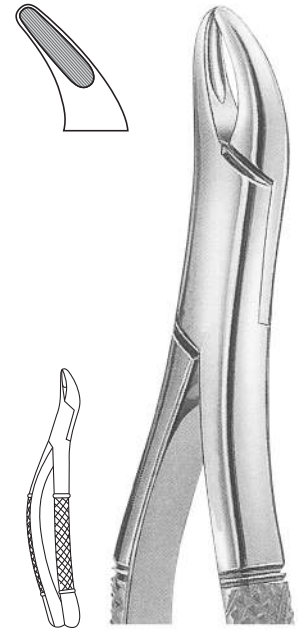
No. 38  
**QI-01-143**  
Upper Anteriors & Roots



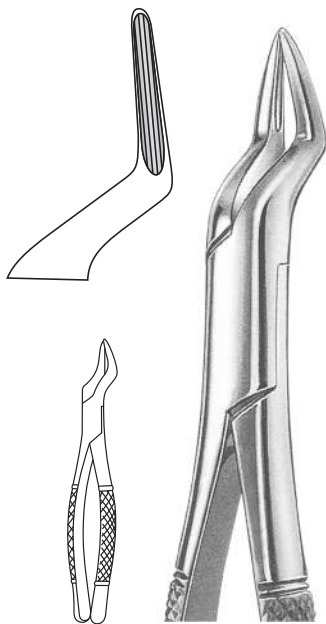
53L  
**QI-01-144**  
Gold Plated  
Upper Molars, left



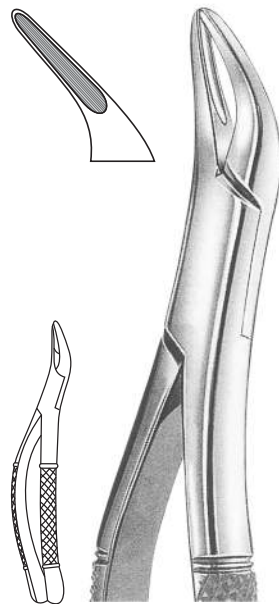
53R  
**QI-01-145**  
Gold Plated  
Upper Molars, right



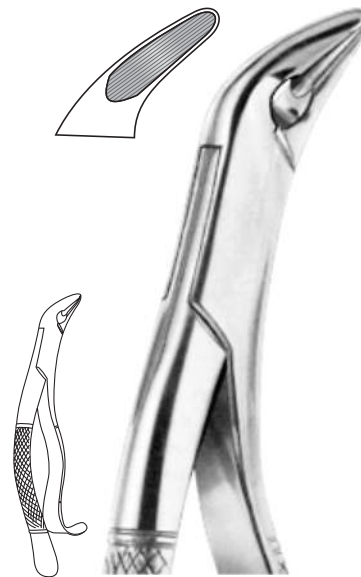
No. 62  
**QI-01-146**  
Upper & Lower Incisors



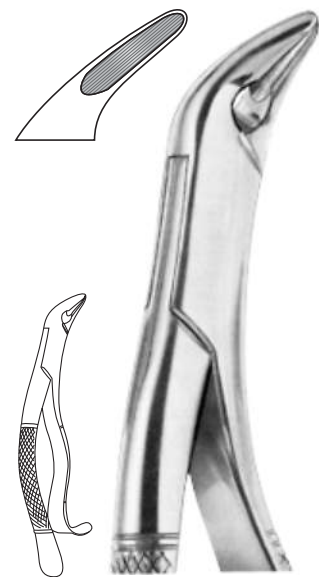
No. 65  
**QI-01-147**  
Gold Plated  
Upper Incisors, Roots & Fragments



No. 69  
**QI-01-148**  
Gold Plated  
Upper & Lower Fragments & Roots

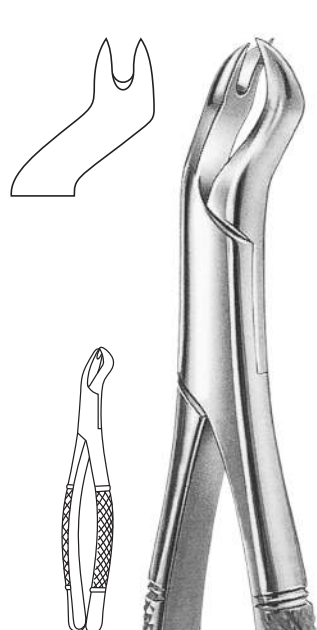


No. 85  
**QI-01-149**  
lower canines,  
premolars and molars

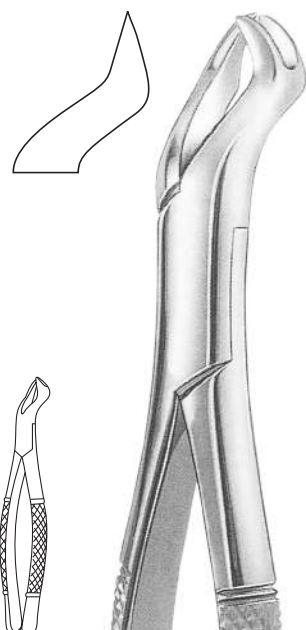


No. 85A  
**QI-01-150**  
lower canines,  
premolars and molars

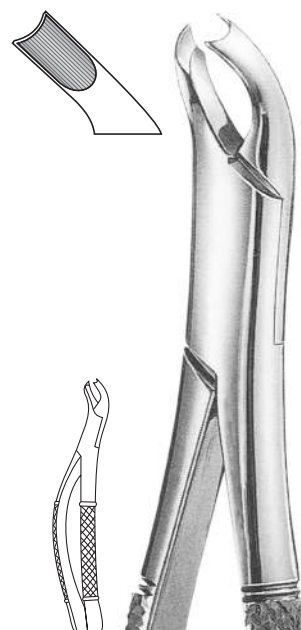
EXTRACTION FORCEPS "AMERICAN PATTERN"  
 PINZA PER ESTRAZIONE "MODELLO AMERICANO"



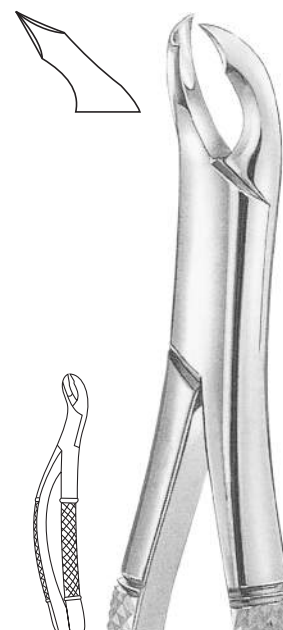
88L  
**QI-01-151**  
 Upper Molars, left



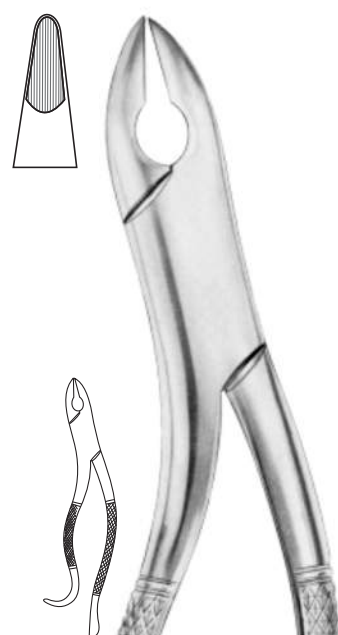
88R  
**QI-01-152**  
 Upper Molars, right



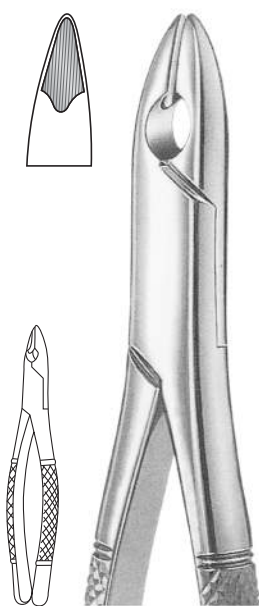
No. 89  
**QI-01-153**  
 Upper Molars, right



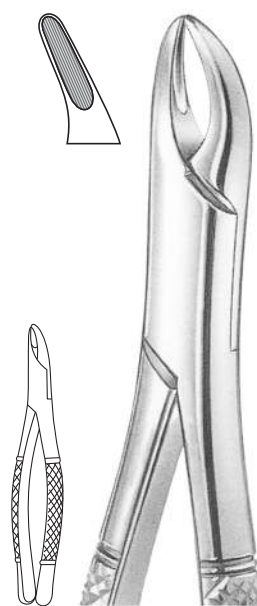
No. 90  
**QI-01-154**  
 Upper Molars, left



Kells  
 99A **QI-01-155**  
 Upper Incisors, Canines, Premolars



Kells  
 99C **QI-01-156**  
 Upper Incisors & Bicuspid



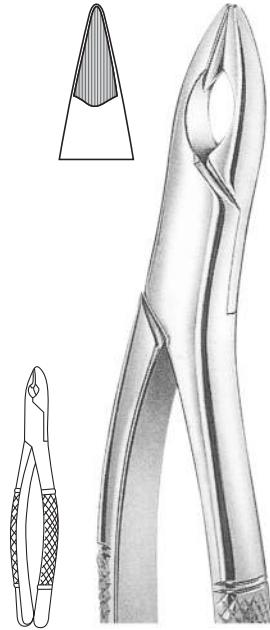
Hull  
 No. 101 **QI-01-157**  
 Universal for Bicuspid & Deciduous



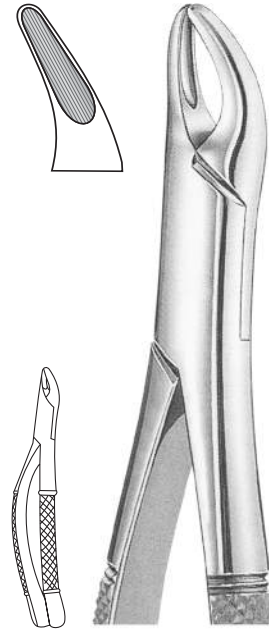
No. 103 **QI-01-158**  
 lower incisors, premolars



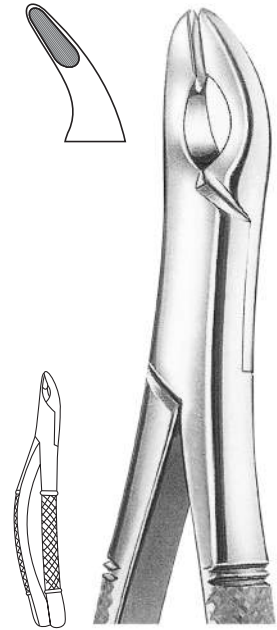
No. 104  
**QI-01-159**  
Upper third molars



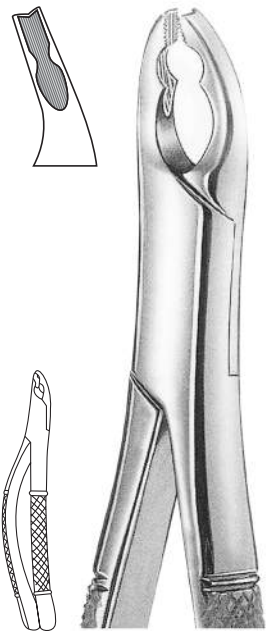
Nevius  
No. 110S **QI-01-160**  
Upper Bicuspid & Cuspids



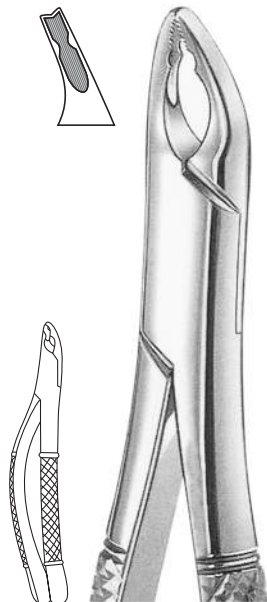
No. 150  
**QI-01-161**  
Upper Incisors, Bicuspid & Roots



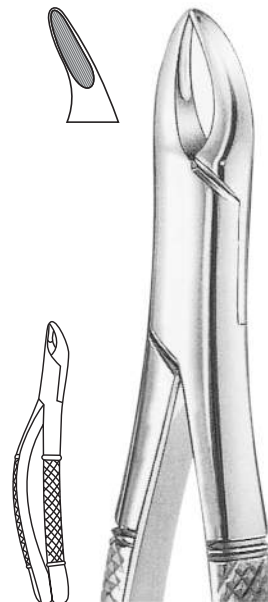
Cryer  
150A **QI-01-162**  
Upper Incisors, Cuspids & Bicuspid



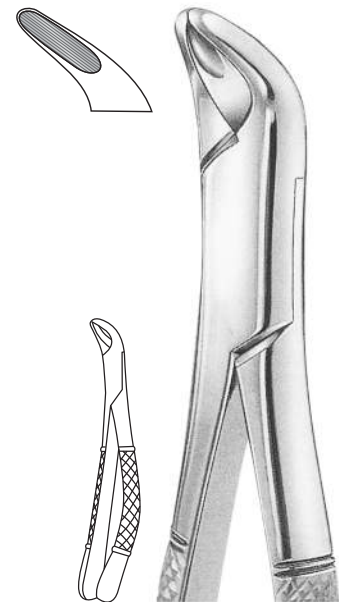
Cryer  
150 AS **QI-01-163**  
Upper Incisors, Cuspids  
serrated jaw



Cryer  
No. 150 XAS **QI-01-164**  
Children, Upper Incisors &  
Cuspids, serrated jaw

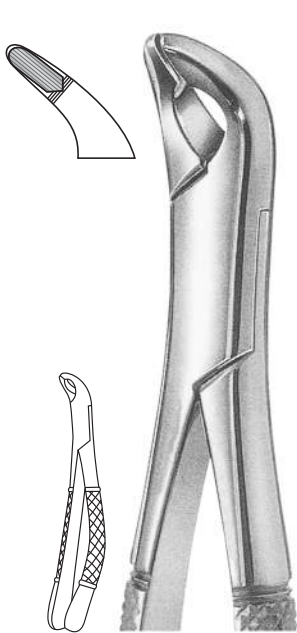


Cryer  
No. 150 S  
**QI-01-165**  
Children, Upper Incisors, Bicuspid & Roots

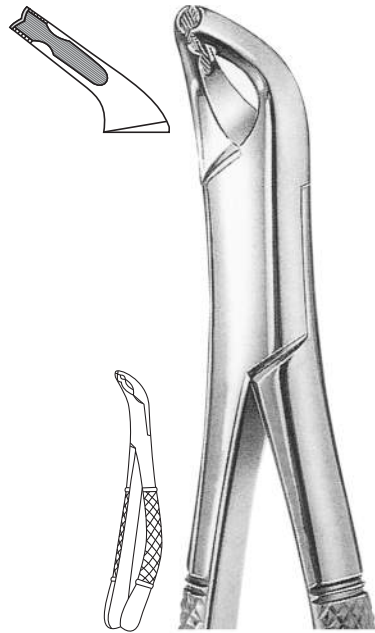


Cryer  
No. 151  
**QI-01-166**  
Lower Incisors, Bicuspid & Roots

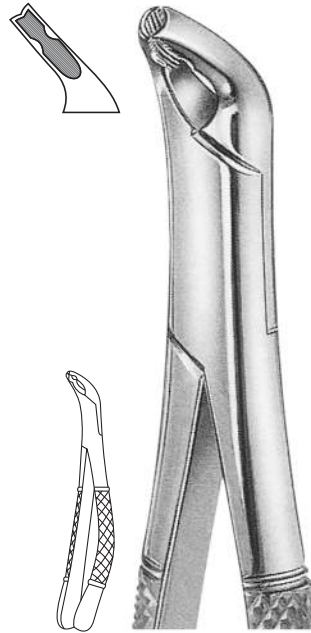
EXTRACTION FORCEPS "AMERICAN PATTERN"  
PINZA PER ESTRAZIONE "MODELLO AMERICANO"



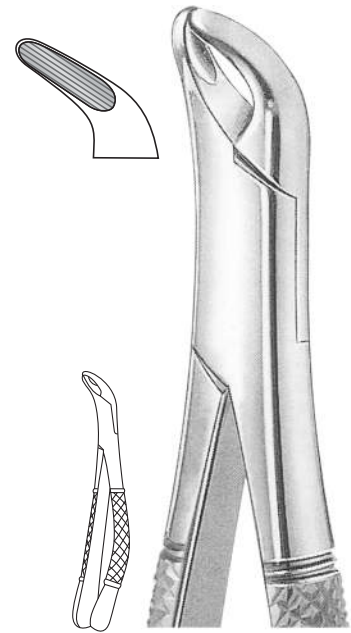
Cryer  
151 A  
**QI-01-167**  
Lower Incisors, Cuspids  
& Bicuspids



Cryer  
151 AS  
**QI-01-168**  
Lower Incisors & Cuspids, serrated jaw



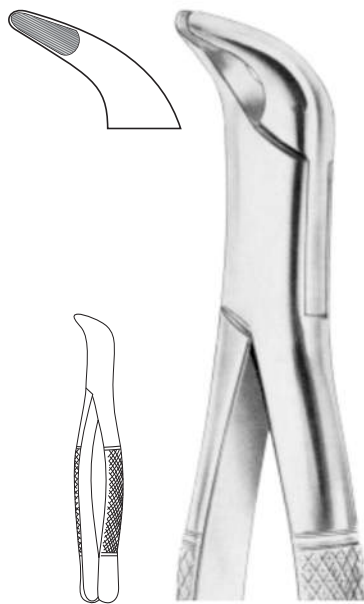
No. 151 XAS  
**QI-01-169**  
Children, Lower Incisors &  
Cuspids, serrated jaw



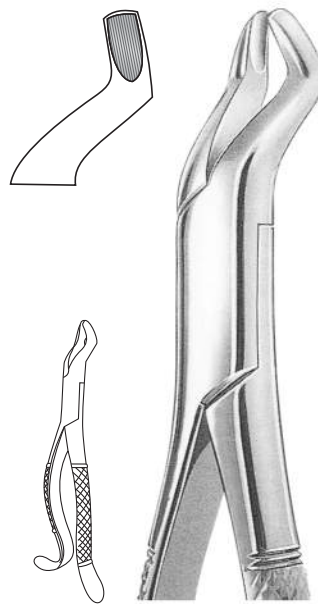
Cryer  
No. 151S  
**QI-01-170**  
Children, Lower incisors, Bicuspids & Roots



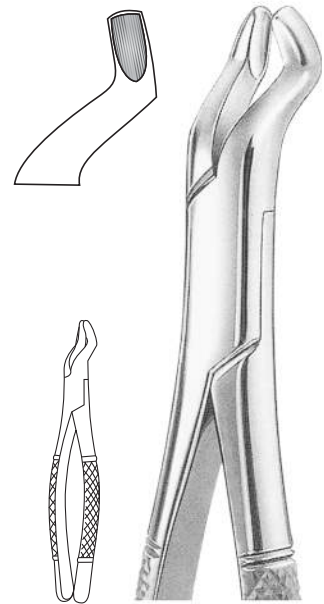
No. 201  
**QI-01-171**  
Upper Incisors, Canines, premolars



No. 203  
**QI-01-172**  
Lower Incisors & Roots



No. 210 H  
**QI-01-173**  
Upper Wisdoms, Hook Handle

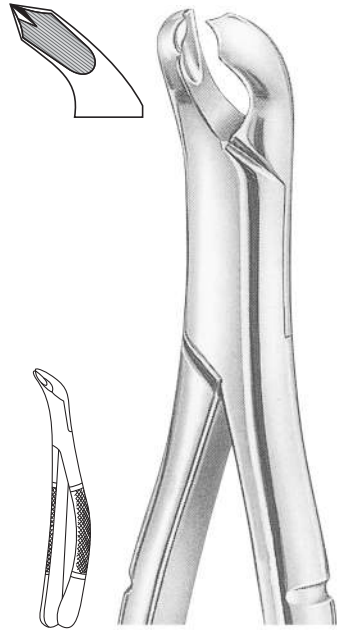


No. 210 S  
**QI-01-174**  
Upper Wisdoms

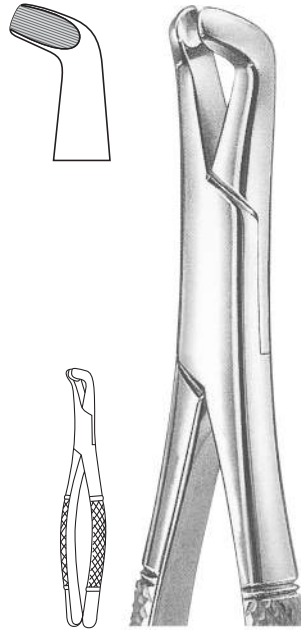




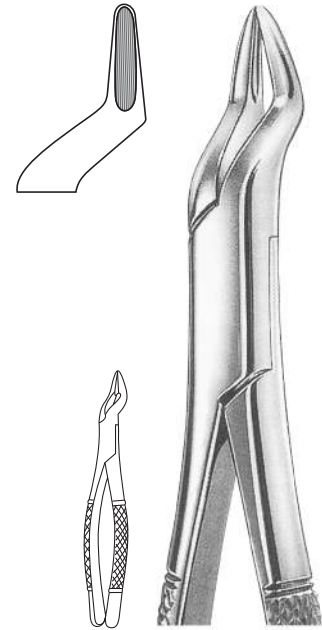
No. 213  
**QI-01-175**  
Upper Centrals & Canines



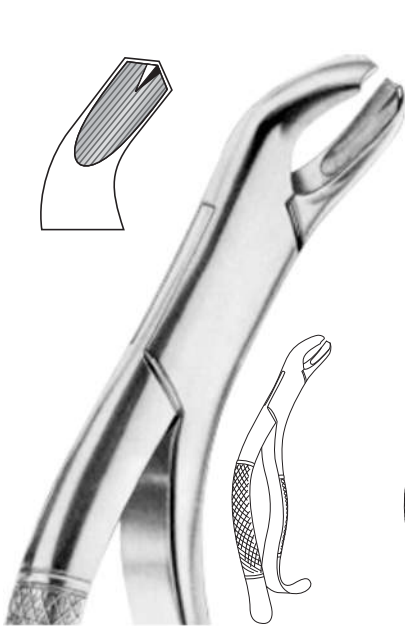
No. 217  
**QI-01-176**  
Lower Molars



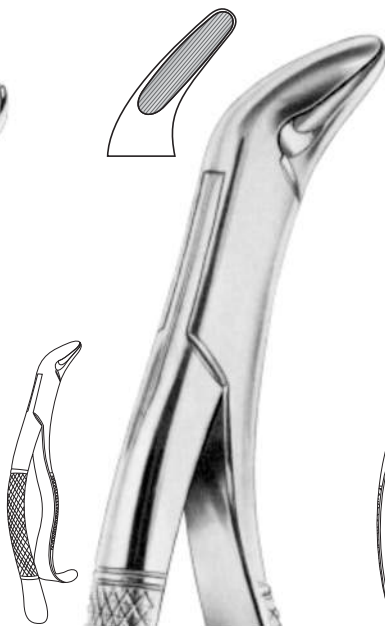
No. 222  
**QI-01-177**  
Lower Wisdoms



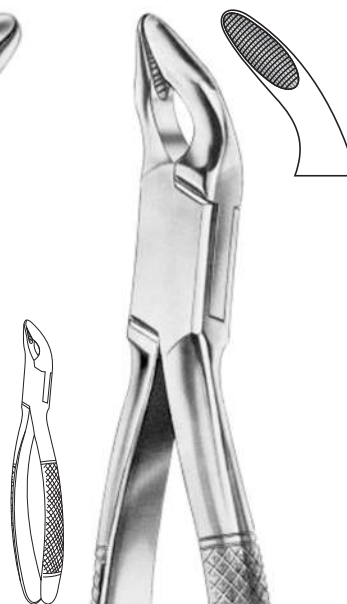
No. 286  
**QI-01-178**  
Upper Incisors, Bicuspid & Roots



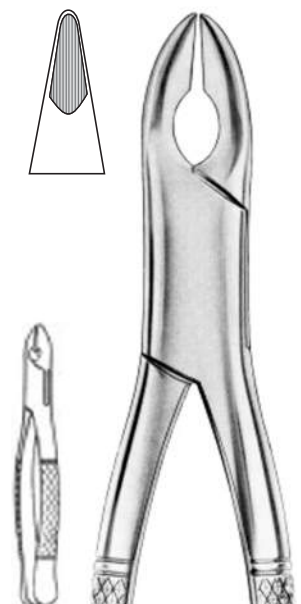
No. 286  
**QI-01-179**  
Swing lower molars



No. 288  
**QI-01-180**  
Lower Canines & Premolars

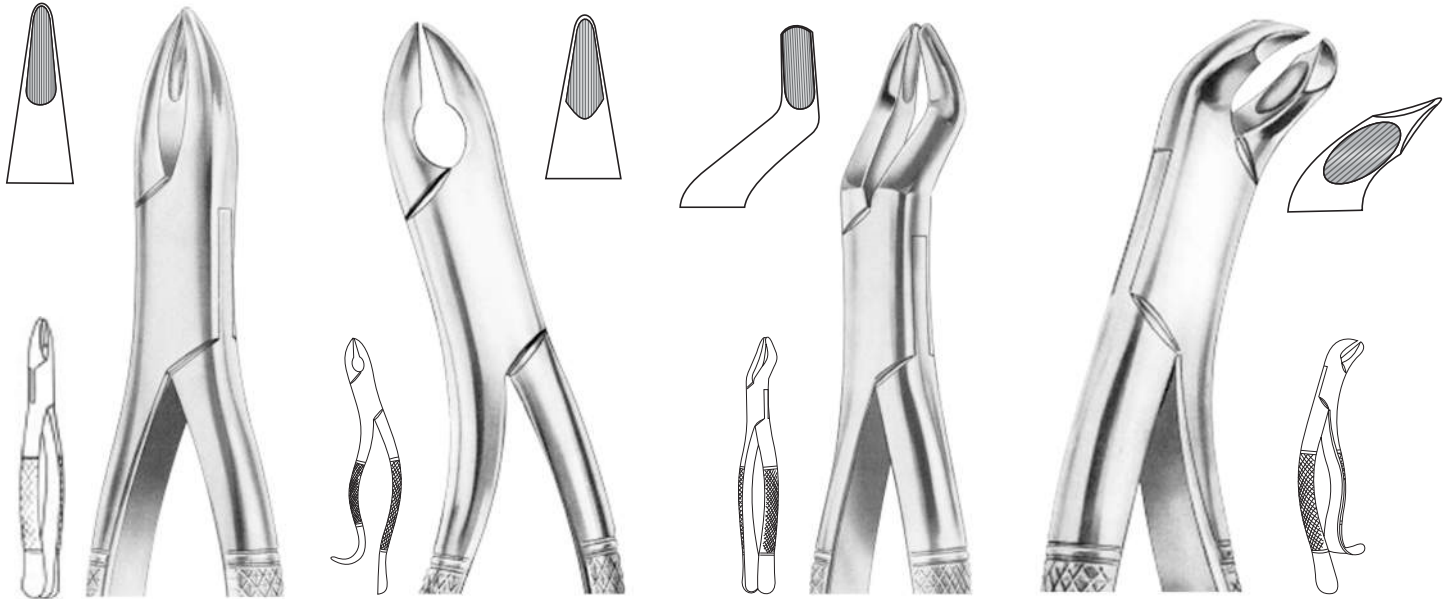


Cohen  
No. 310 **QI-01-181**  
Universal Forceps



Nevius  
No. 10S **QI-01-182**  
Upper Canines

EXTRACTION FORCEPS "AMERICAN PATTERN"  
 PINZA PER ESTRAZIONE "MODELLO AMERICANO"

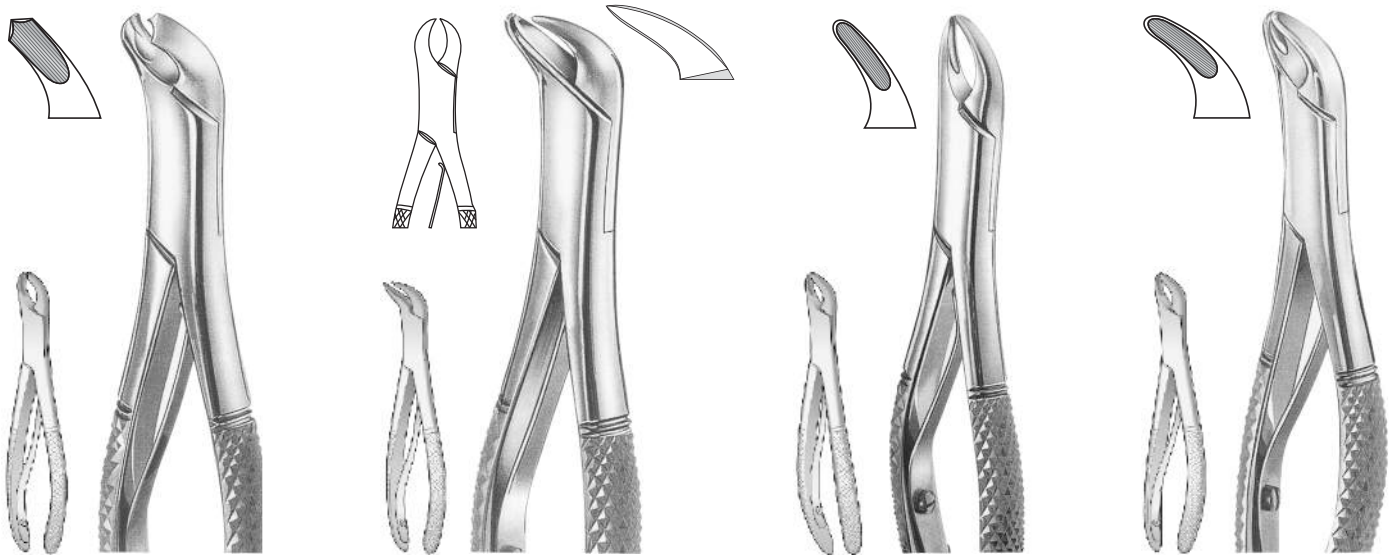


Henahan  
 No. 315A  
**QI-01-183**  
 Upper Incisors

Nevius  
 No. 325/10H  
**QI-01-184**  
 Upper Canines

Standard  
 No. 330  
**QI-01-185**  
 Upper Third Molars

Woodward  
 No. 335  
**QI-01-186**  
 Lower Molars



No. 17-K  
**QI-01-187**  
 children Lower Molars

No. 23-K  
**QI-01-188**  
 children Lower Molars

No. 150-K  
**QI-01-189**  
 Children, Upper Incisors,  
 Bicuspids & Roots

No. 151-K  
**QI-01-190**  
 Children, Lower Incisors,  
 Bicuspids & Roots



02

Page 21-35

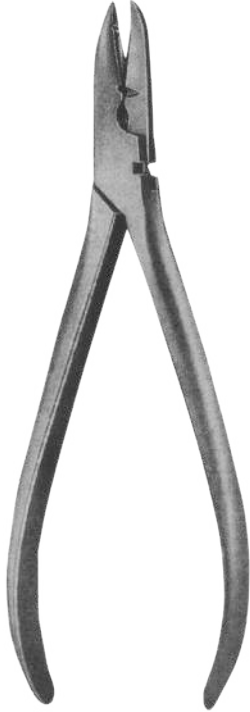
## Pliers

Pliers for Orthodontics & Prosthetics

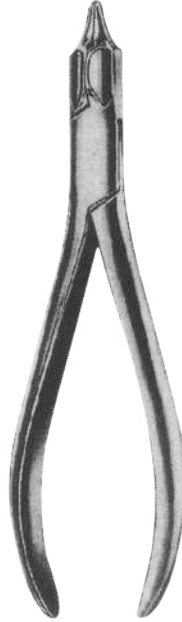
Carbide Inserted Pliers

Orthodontics Pliers Stand

Bone Rongeurs



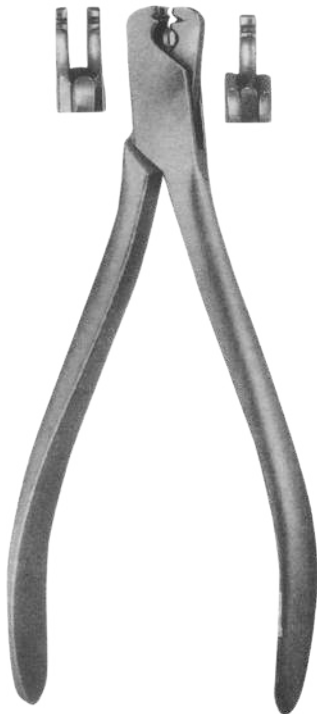
**QI-02-001**  
Waldsachs  
15 cm



**QI-02-002**  
Universal  
16 cm



**QI-02-003**  
Nance  
13.5 cm



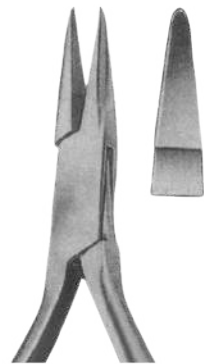
**QI-02-004**  
Aderer  
14.5 cm



**QI-02-005**  
Model Marburg  
Serrated Jaws  
14 cm



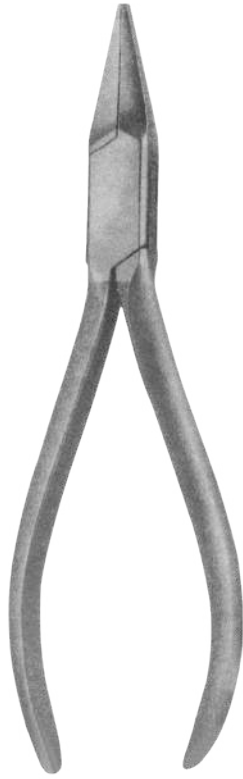
**QI-02-006**  
Model Marburg  
Smooth Jaws  
14 cm



**QI-02-007**  
Model Marburg  
Smooth Jaws  
14 cm



**QI-02-008**  
Goslee  
Serrated Jaws  
14 cm



**QI-02-009**  
Flat Pliers  
14 cm



**QI-02-010**  
14 cm



**QI-02-011**  
14 cm



**QI-02-012**  
14 cm



**QI-02-013**  
14 cm



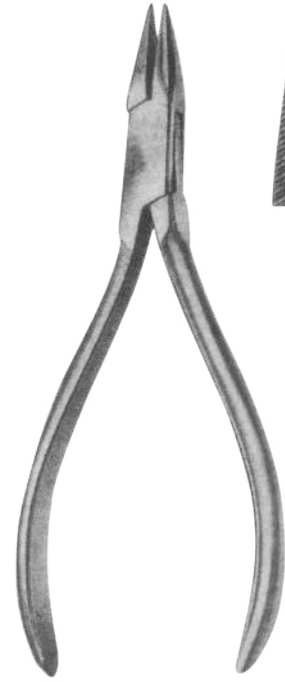
**QI-02-014**  
14 cm



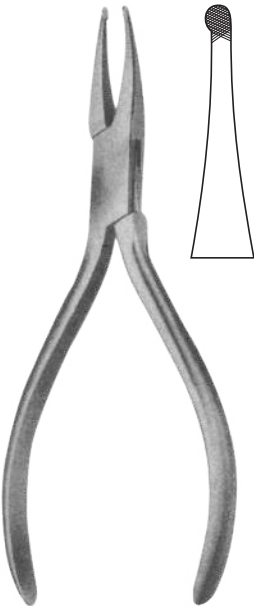
**QI-02-015**  
14 cm



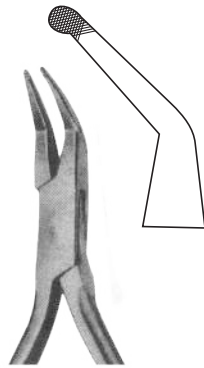
**QI-02-016**  
14 cm



**QI-02-017**  
Serrated Jaws  
12 cm



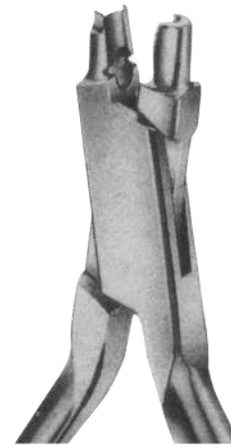
**QI-02-018**  
How  
14.5 cm



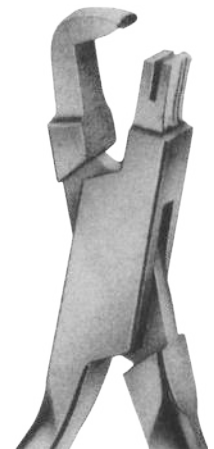
**QI-02-019**  
How  
14.5 cm



**QI-02-020**  
How  
14.5 cm



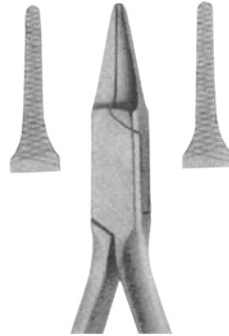
**QI-02-021**  
Arrow Clasp Forming  
12 cm



**QI-02-022**  
Arrow Clasp Forming  
12 cm



**QI-02-023**  
Peeso  
13.5 cm



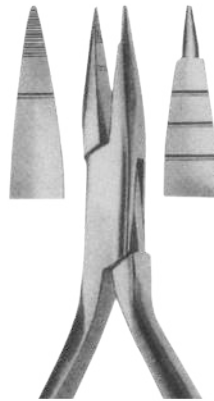
**QI-02-024**  
Peeso  
13.5 cm



**QI-02-025**  
14 cm



**QI-02-026**  
Langenbeck  
14 cm



**QI-02-027**  
Jarabak  
14 cm



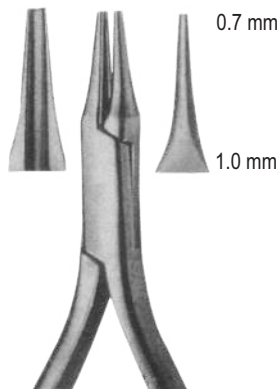
**QI-02-028**  
Bending Plier  
13 cm



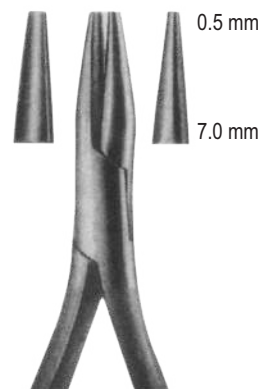
**QI-02-029**  
Angle  
12.5 cm



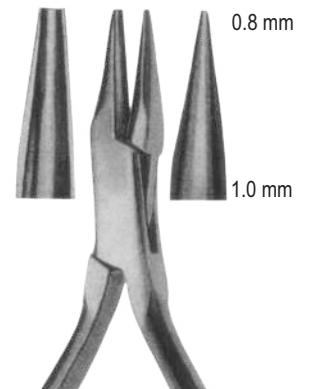
**QI-02-030**  
Andresen  
13 cm



**QI-02-031**  
Bending Plier  
13.5 cm



**QI-02-032**  
Schwarz  
13.5 cm



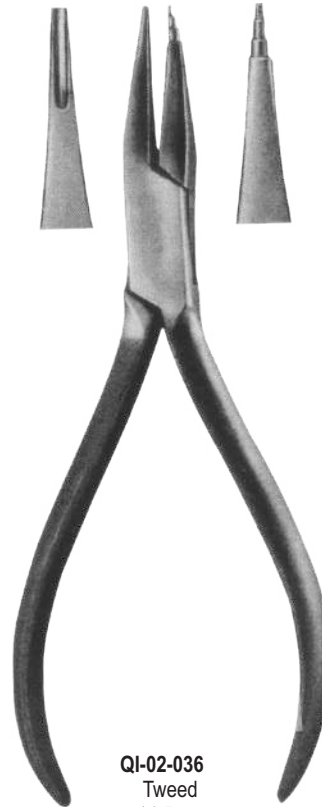
**QI-02-033**  
Fischer  
13 cm



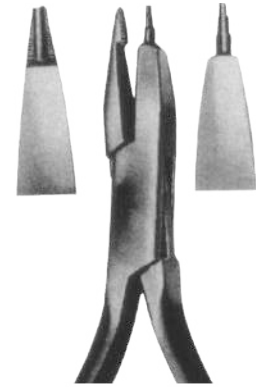
**QI-02-034**  
Aderer  
12 cm



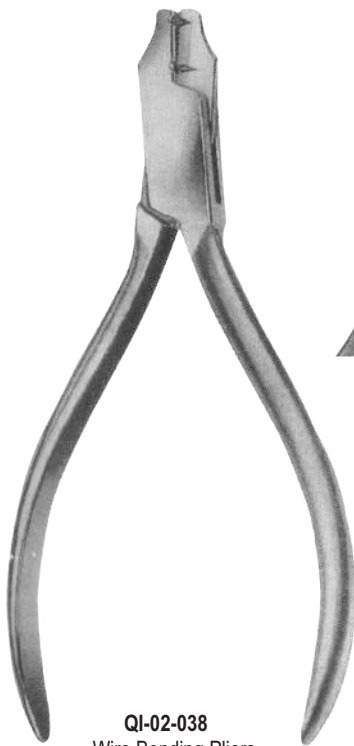
**QI-02-035**  
Aderer-Heavy  
12 cm



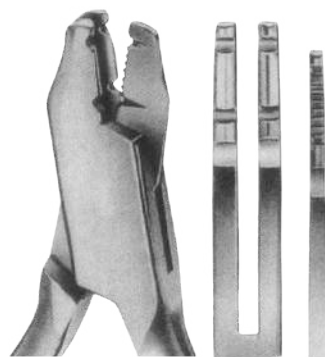
**QI-02-036**  
Tweed  
14.5 cm



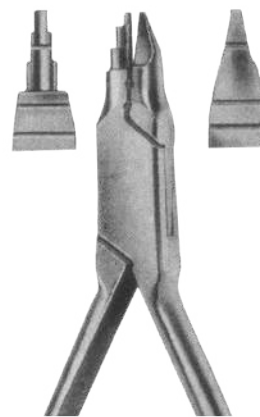
**QI-02-037**  
O'brien  
13.5 cm



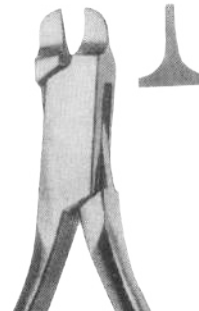
**QI-02-038**  
Wire Bending Pliers  
12.5 cm



**QI-02-039**  
Adams  
12.5 cm



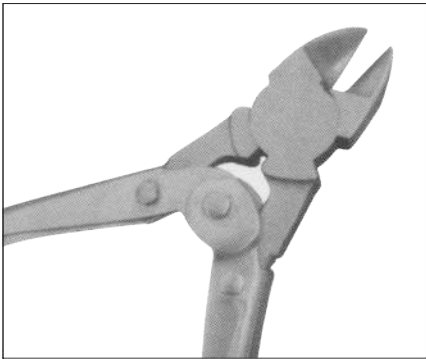
**QI-02-041**  
Young  
14 cm



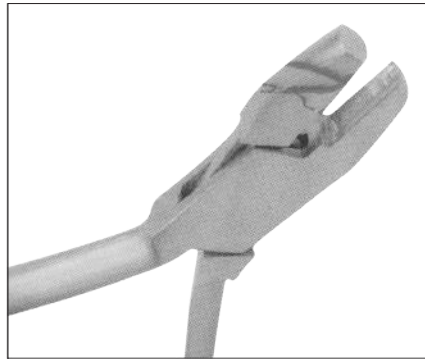
**QI-02-040**  
Frevert  
12.5 cm



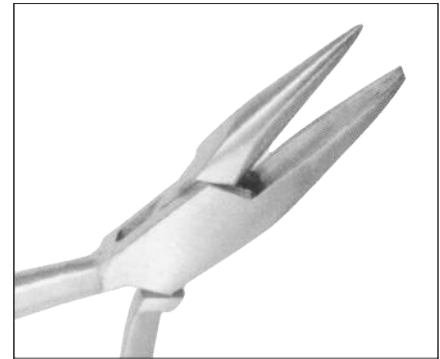
**QI-02-042**  
Clasp Forming  
14 cm



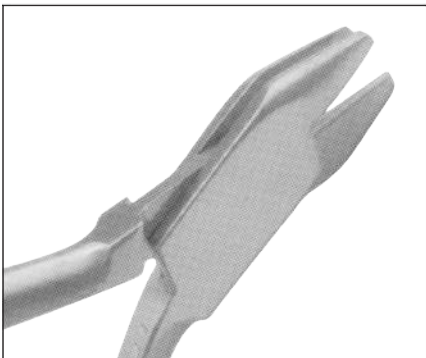
**QI-02-043**  
Hard Wire Cutter  
5 1/2" (14 cm)



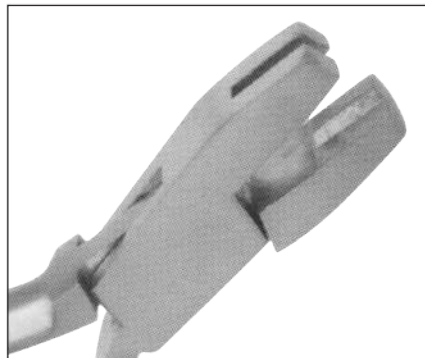
**QI-02-044**  
Arch Forming Plier  
5 1/2" (14 cm)



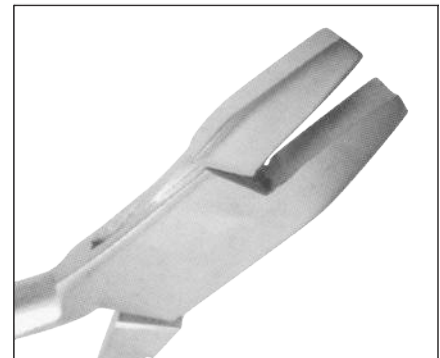
**QI-02-045**  
Medium Size Bending Plier  
5 1/2" (14 cm)



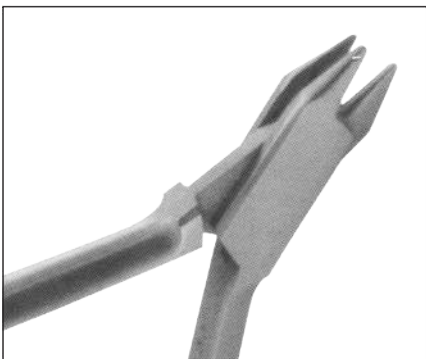
**QI-02-046**  
Aderer Pliers  
5 1/2" (14 cm)



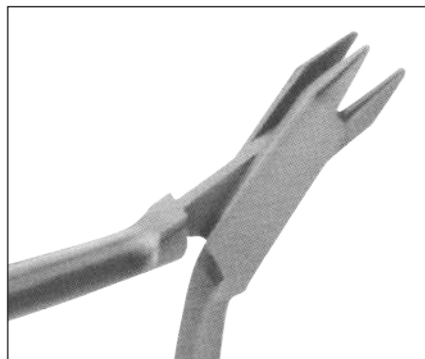
**QI-02-047**  
Wire Bending Plier  
5 1/2" (14 cm)



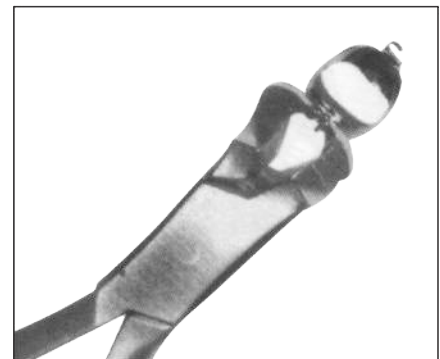
**QI-02-048**  
Round & Concave Pliers  
5 1/2" (14 cm)



**QI-02-049**  
Aderer Pliers  
with Narrow Standing Points,  
for Bending Wires up to  $\varnothing$  0.5 mm,  
Disinfectable, Sterilizable  
4 3/4" (12 cm)

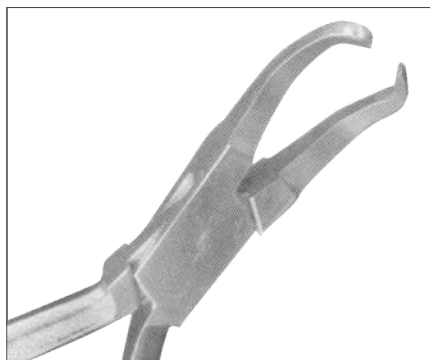


**QI-02-050**  
Aderer Pliers  
for Bending Wires up to  $\varnothing$  0.9 mm,  
Disinfectable, Sterilizable  
4 3/4" (12 cm)



**QI-02-051**  
Aderer Pliers  
Bending Plier for Lingual Cleat  
5 1/2" (14 cm)

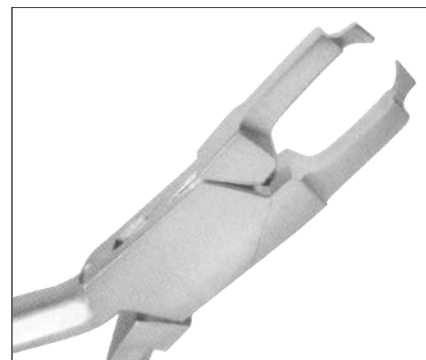




**QI-02-052**  
Bracket Removing Pliers  
5 1/2" (14 cm)



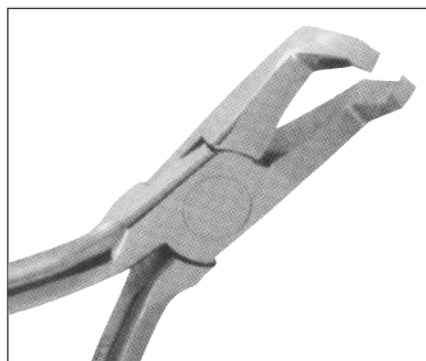
**QI-02-053**  
Bracket Removing Pliers  
5 1/2" (14 cm)



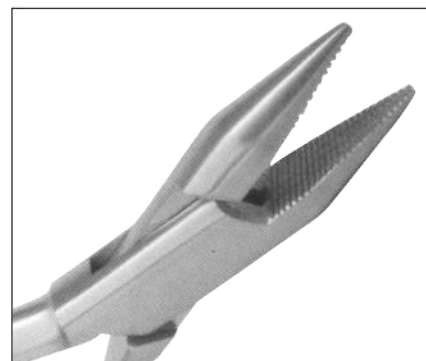
**QI-02-054**  
Bracket Removing Pliers  
5 1/2" (14 cm)



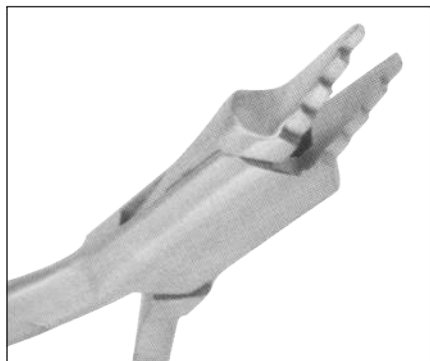
**QI-02-055**  
Bracket Removing Pliers  
5 1/2" (14 cm)



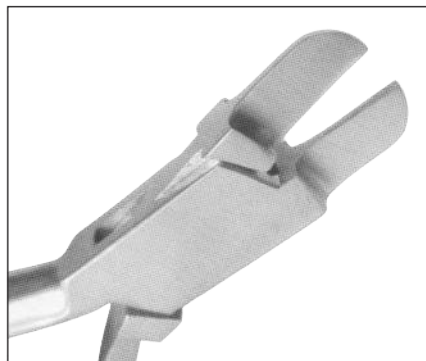
**QI-02-056**  
Bracket Removing Pliers  
5 1/2" (14 cm)



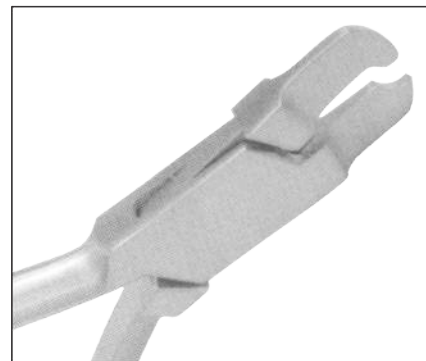
**QI-02-057**  
Flat Pliers  
5 1/2" (14 cm)



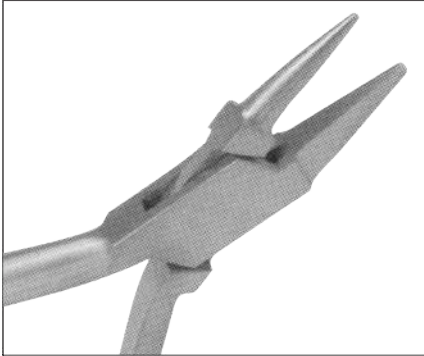
**QI-02-058**  
Nance Closing Loop Pliers  
5 1/2" (14 cm)



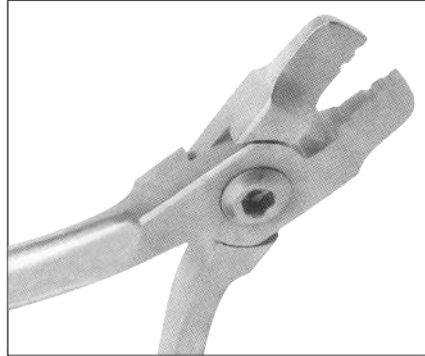
**QI-02-059**  
Angle Banding Pliers  
5 1/2" (14 cm)



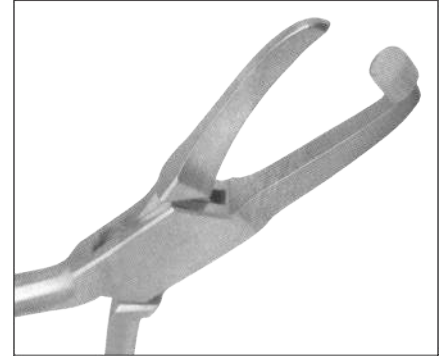
**QI-02-060**  
Crown Crimping Pliers  
5 1/2" (14 cm)



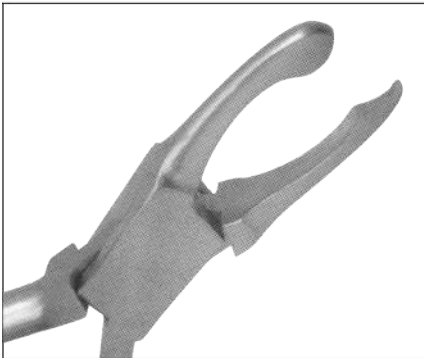
**QI-02-061**  
Round & Flat Plier  
5 1/2" (14 cm)



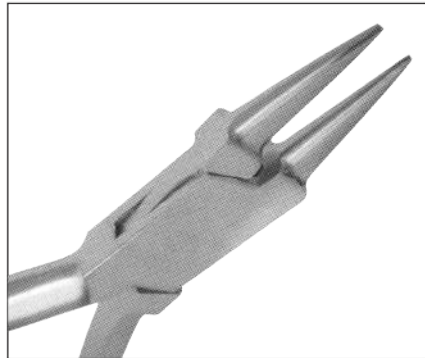
**QI-02-062**  
Tweed Angle Arch Bending  
5 1/2" (14 cm)



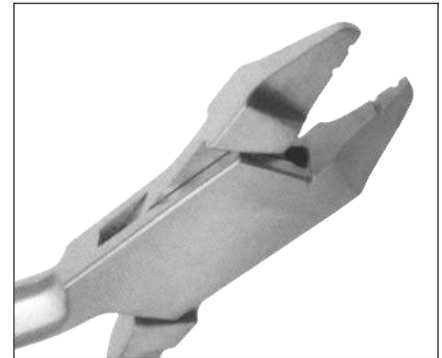
**QI-02-063**  
Bend Removing Pliers  
5 1/2" (14 cm)



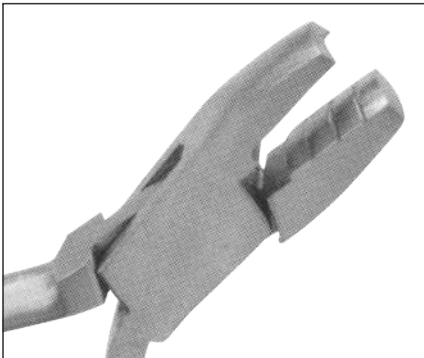
**QI-02-064**  
Johnson Contouring Pliers  
5 1/2" (14 cm)



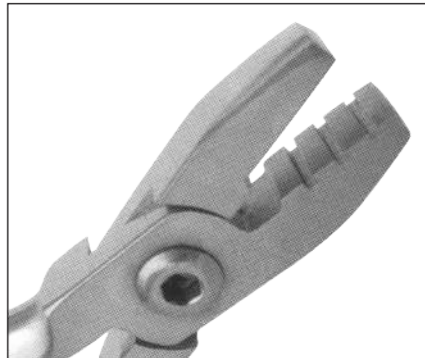
**QI-02-065**  
Round Nose Pliers  
5 1/2" (14 cm)



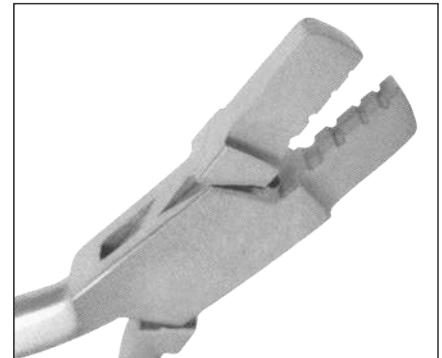
**QI-02-066**  
Tweed Angle Arch Bending  
5 1/2" (14 cm)



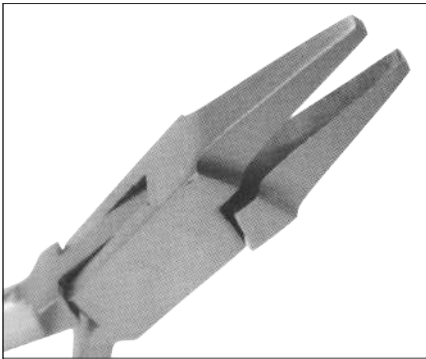
**QI-02-067**  
De La Rosa Pliers  
5 1/2" (14 cm)



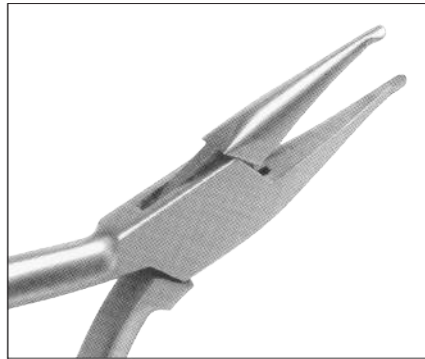
**QI-02-068**  
Arch Forming Pliers  
5 1/2" (14 cm)



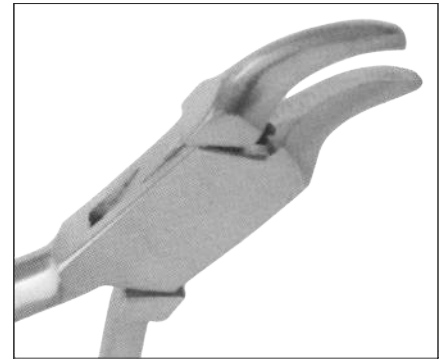
**QI-02-069**  
Tweed Angle Arch Bending  
5 1/2" (14 cm)



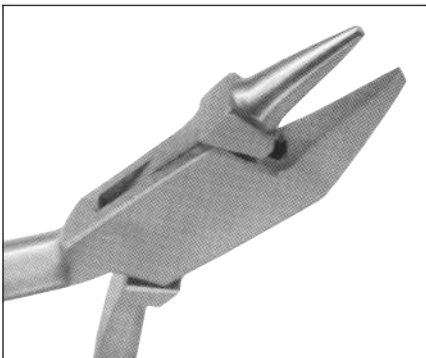
**QI-02-070**  
Flat Nose Pliers  
5 1/2" (14 cm)



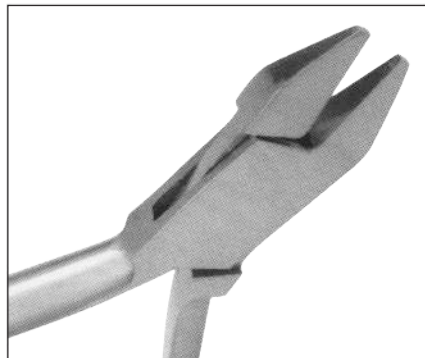
**QI-02-071**  
How Pliers  
5 1/2" (14 cm)



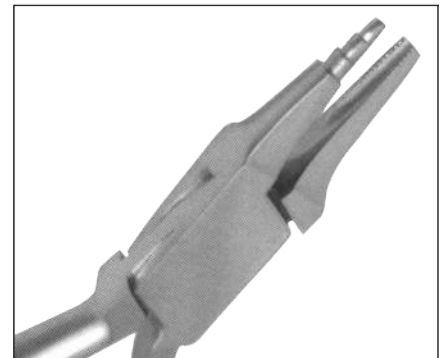
**QI-02-072**  
Gordon - Contouring  
5 1/2" (14 cm)



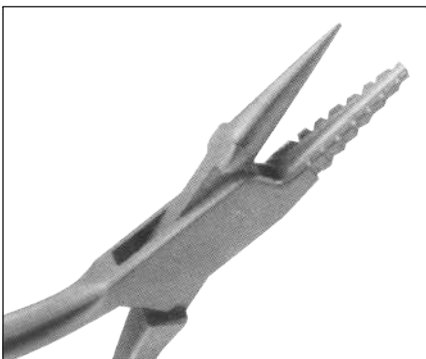
**QI-02-073**  
Adams Pliers  
5 1/2" (14 cm)



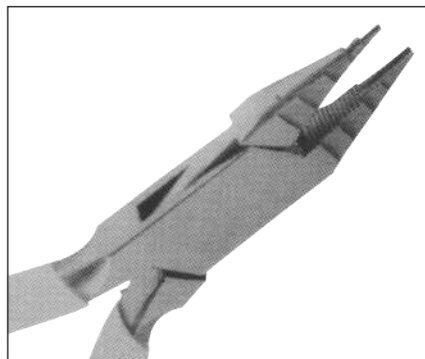
**QI-02-074**  
Adams Pliers  
5 1/2" (14 cm)



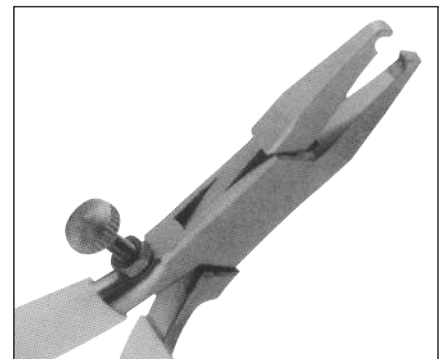
**QI-02-075**  
Tweed Pliers  
5 1/2" (14 cm)



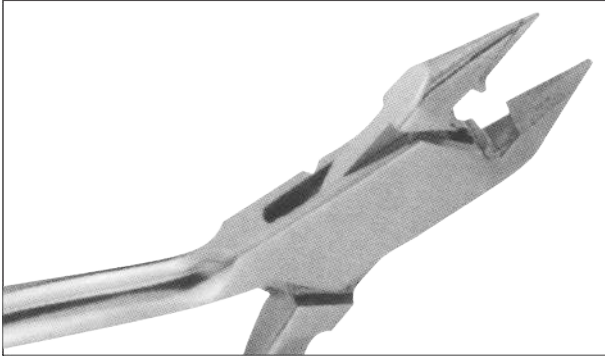
**QI-02-076**  
Bending Pliers  
Medium Fine, with Graduation  
for Wire up  $\varnothing$  1.0 mm  
5 1/2" (14 cm)



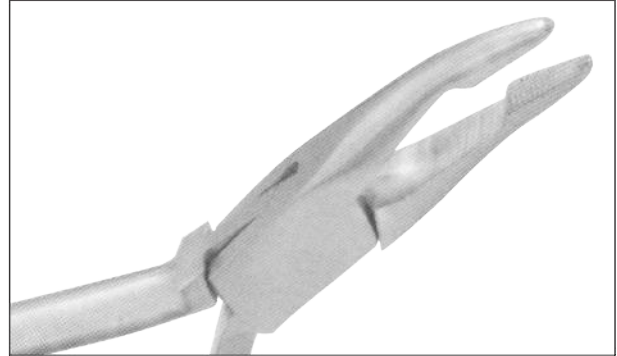
**QI-02-077**  
Special Pliers  
Max .022" x .028"  
5 1/2" (14 cm)



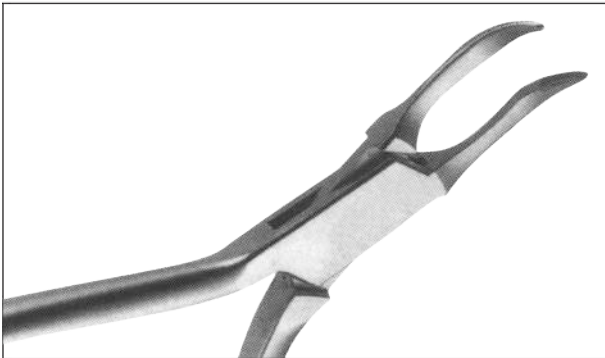
**QI-02-078**  
Pliers for Operating  
the Mobil-Stop  
5 1/2" (14 cm)



**QI-02-079**  
Light Wire Plier for Wires  
up to  $\varnothing$  0.60 mm  
with Cutter Begg  
4 3/4" (12 cm)



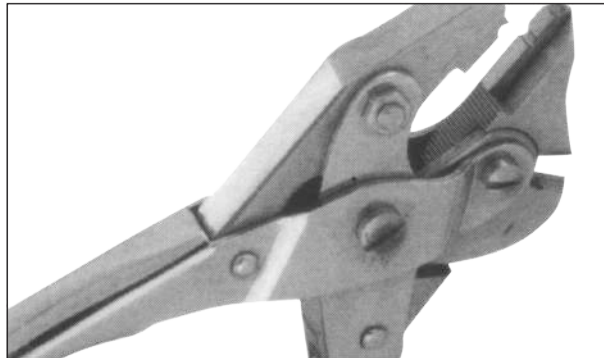
**QI-02-080**  
Weingart Universal Pliers  
5 1/2" (14 cm)



**QI-02-081**  
Weingart Ultra Lightwire Pliers  
5 1/2" (14 cm)

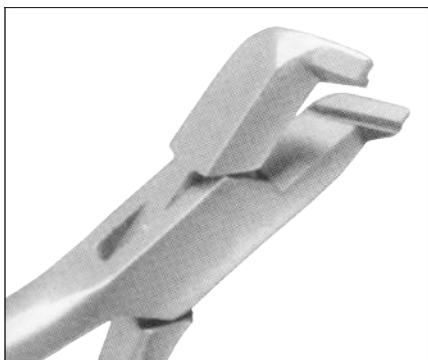


**QI-02-082**  
Weingart Universal Lightwire Pliers  
5 1/2" (14 cm)

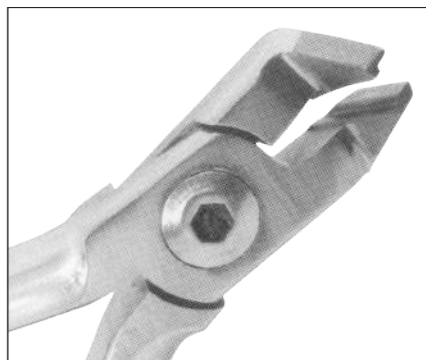


**QI-02-083**  
Universal Facebow Pliers  
6 1/2" (16.5 cm)

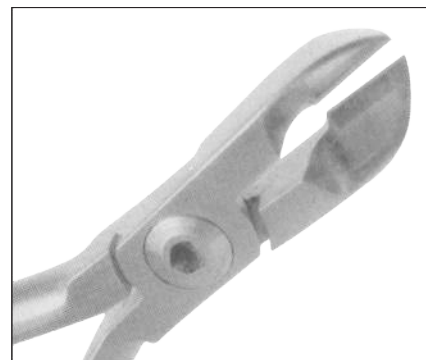
CARBIDE INSERTED PLIERS  
PINZE CON INSERTO IN METALLO DURO



**QI-02-084**  
Distal Cutter Light Weight  
5 1/2" (14 cm)



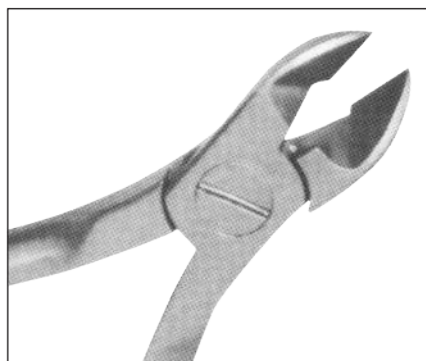
**QI-02-085**  
Distal Cutter Medium  
5 1/2" (14 cm)



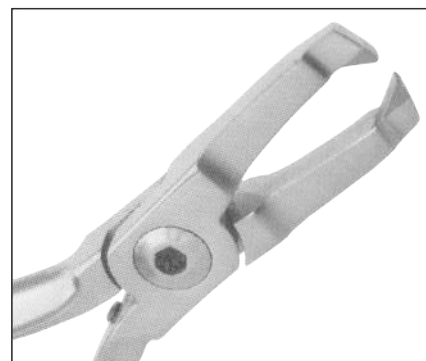
**QI-02-086**  
Ligature Pin Cutter  
5 1/2" (14 cm)



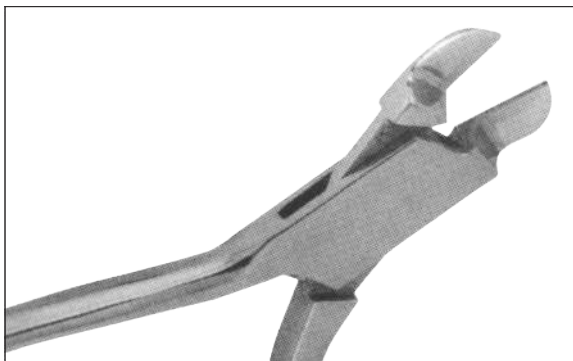
**QI-02-087**  
Hard Wire Cutter  
5 1/2" (14 cm)



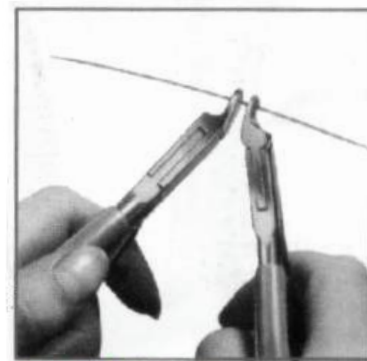
**QI-02-088**  
Hard Wire Cutter  
5 1/2" (14 cm)



**QI-02-089**  
Bracket Removing Pliers  
5 1/2" (14 cm)



**QI-02-090**  
Arch Torquing and Bending Pliers  
for Wires up to  $\varnothing$ 0.60 mm  
Allow to User a Pair  
4 3/4" (12 cm)

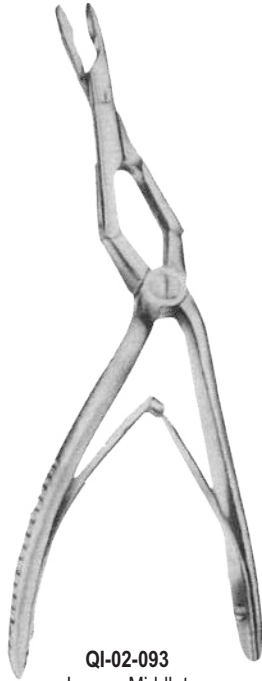




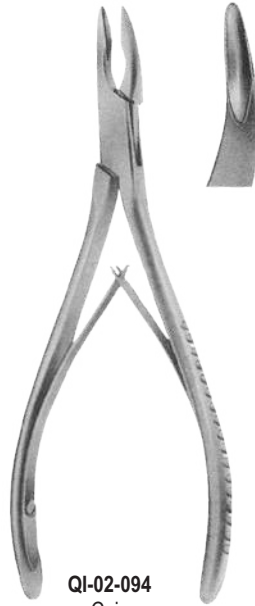
QI-02-091  
Pliers Stand



**QI-02-092**  
Bayer  
150 mm (6")  
5 mm Bite



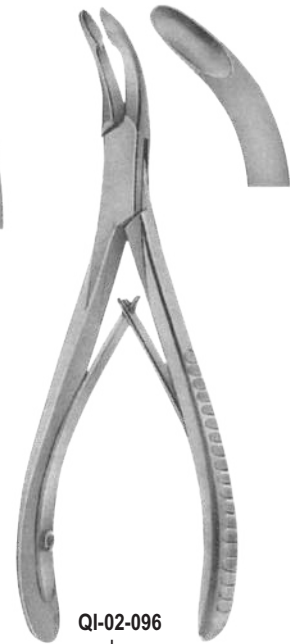
**QI-02-093**  
Jansen-Middleton  
Septum Forceps  
200 mm (8") Spoon Shaped  
4 mm Bite



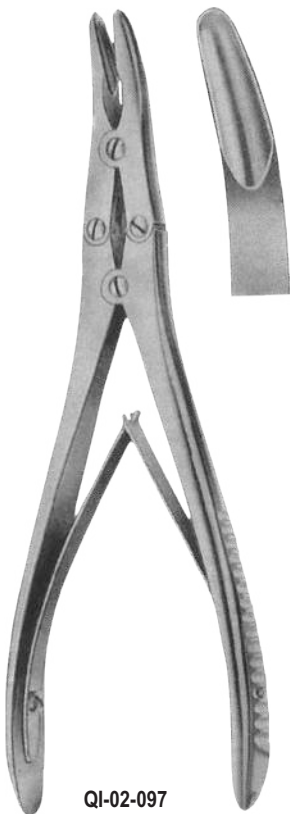
**QI-02-094**  
Cairns  
140 mm (5.1/2")  
4 mm Bite



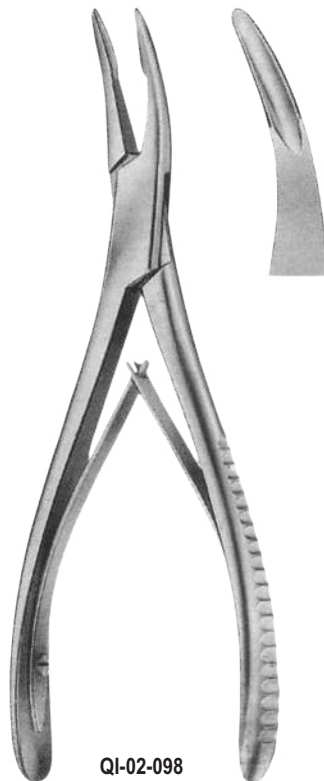
**QI-02-095**  
Cairns  
140 mm (5.1/2")  
4 mm Bite



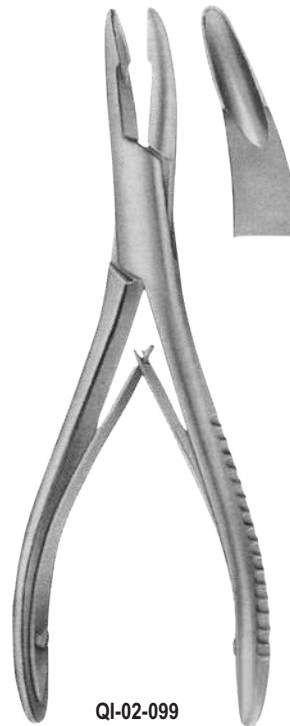
**QI-02-096**  
Luer  
155 mm (6")



**QI-02-097**  
Ruskin  
190 mm (7.1/2")  
6 mm Bite



**QI-02-098**  
Hartmann  
180 mm (7")



**QI-02-099**  
Mead  
165 mm (6.1/2")



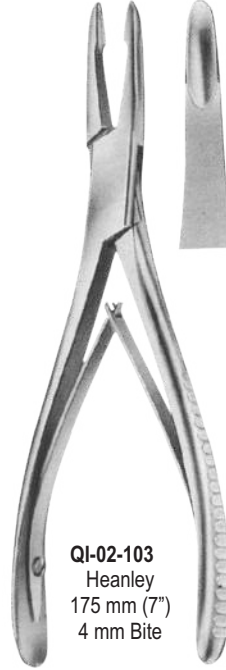
**QI-02-100**  
Jansen  
150 mm (6")



**QI-02-101**  
Trotter  
200 mm (8")  
10 mm Bite



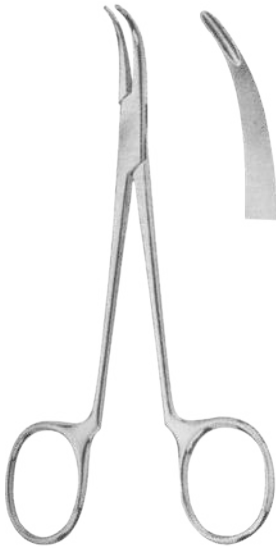
**QI-02-102**  
Synovectomy  
Rongeur  
175 mm (7")



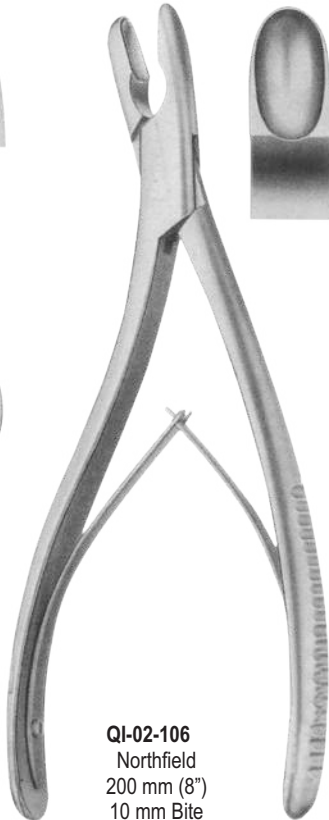
**QI-02-103**  
Heanley  
175 mm (7")  
4 mm Bite



**QI-02-104**  
Pennybacker  
200 mm (8")  
4 mm Bite



**QI-02-105**  
Synovectomy Rongeur  
130 mm (5.1/8")  
Jaw Width 2 mm



**QI-02-106**  
Northfield  
200 mm (8")  
10 mm Bite



**QI-02-107**  
Wilms  
200 mm (8")  
4 mm Bite

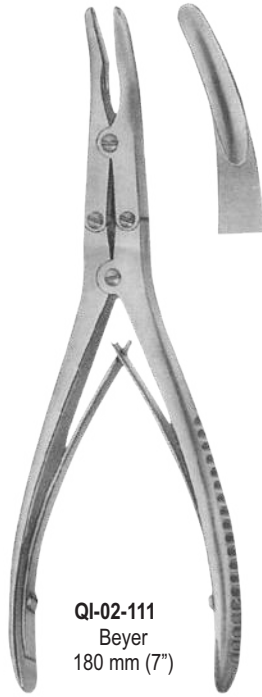


Leksell  
**QI-02-108**  
240 mm (9.1/2")  
6 mm Bite  
**QI-02-109**  
240 mm (9.1/2")  
8 mm Bite





**QI-02-110**  
Luer-Janen  
170 mm (6.3/4")  
4 mm Bite



**QI-02-111**  
Beyer  
180 mm (7")



**QI-02-112**  
Beyer  
200 mm (8")



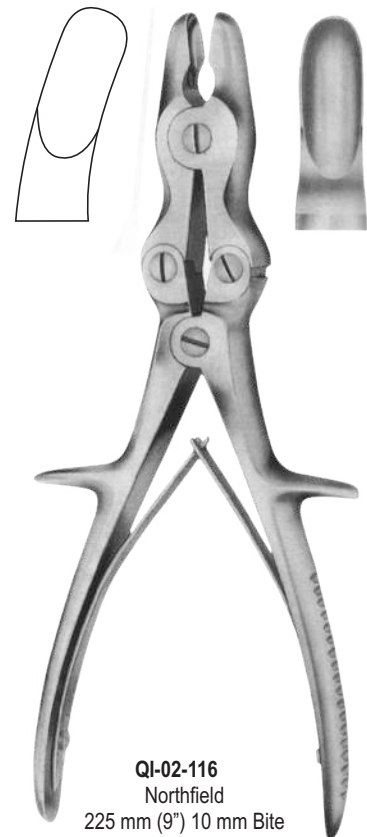
**QI-02-113**  
Killearn  
197 mm (7.3/4")  
3 mm Bite



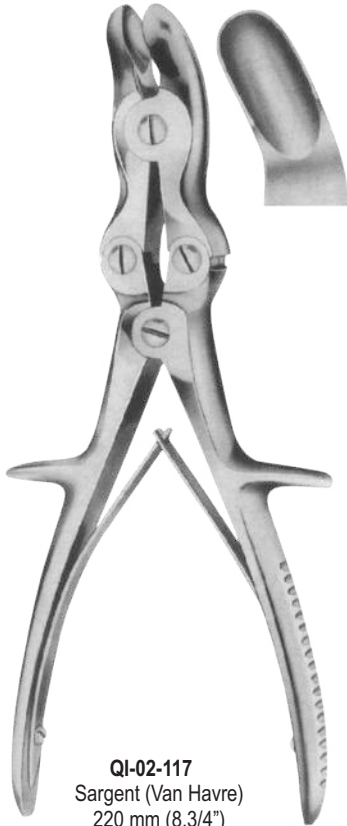
**QI-02-114**  
Zaufal-Jansen  
240 mm (9.1/2")



**QI-02-115**  
Echlin  
240 mm (9.1/2")



**QI-02-116**  
Northfield  
225 mm (9") 10 mm Bite



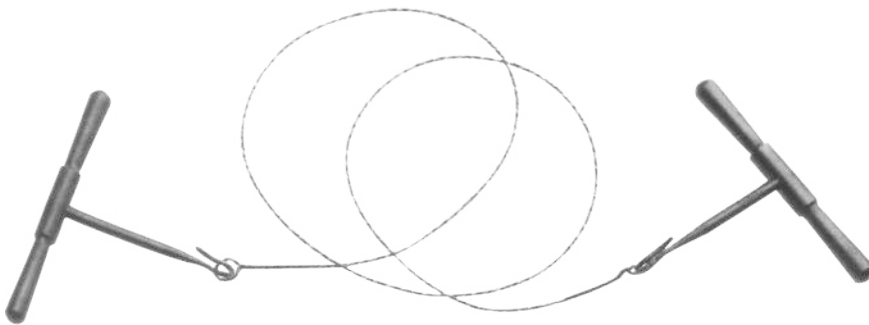
**QI-02-117**  
Sargent (Van Havre)  
220 mm (8.3/4")  
10 mm Bite



**QI-02-118**  
Olivecrona  
230 mm (9")  
6 mm Bite



**QI-02-119**  
Stille-Ruskin  
240 mm (9.1/2")



**QI-02-120**  
Gigli Saw With Handle  
500 mm (20")



**QI-02-121**  
Rudor Edwards Costotome  
230 mm (9")

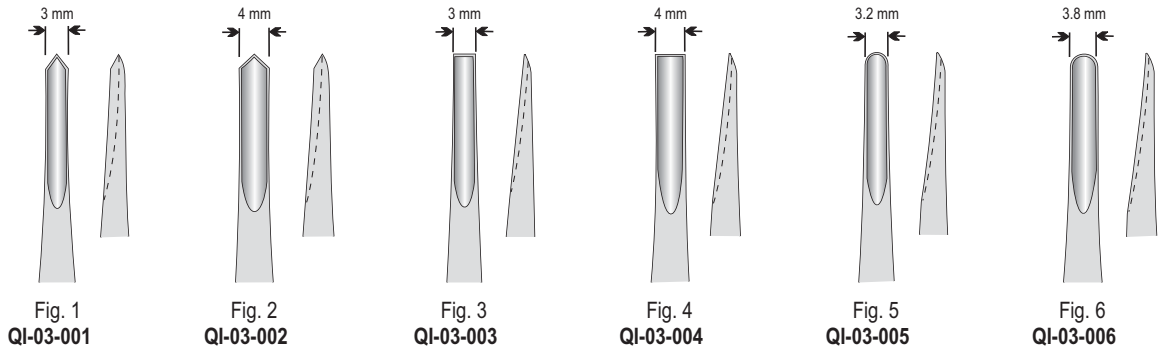


03

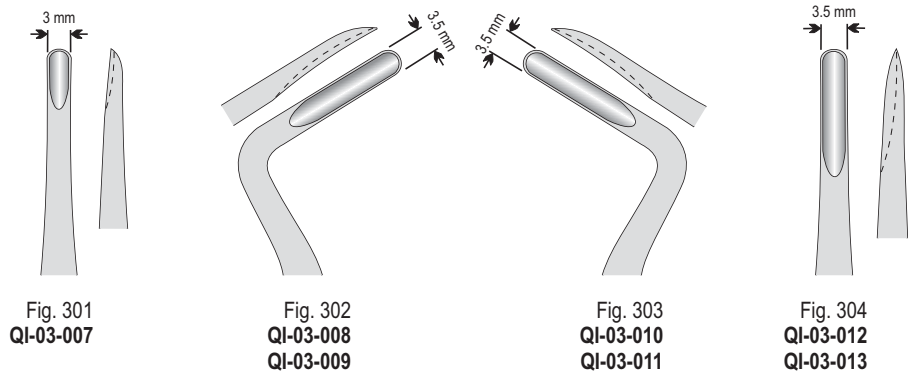
Page 36-42

Elevators  
Root Elevators  
Syndesmotomes

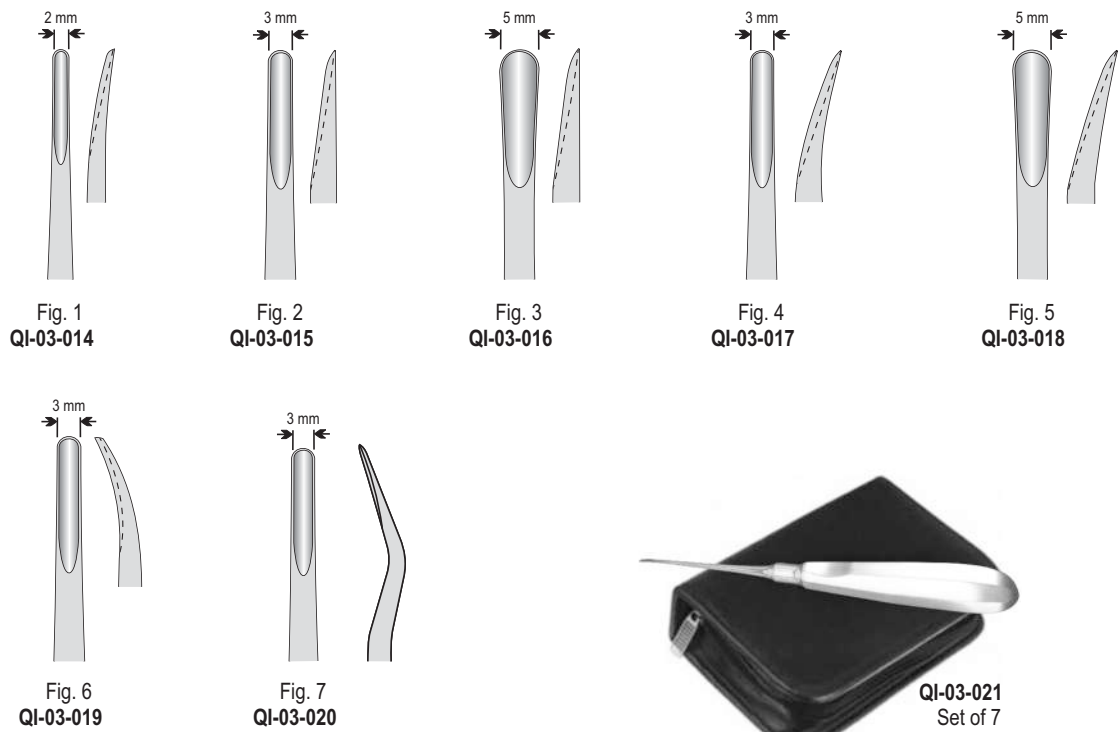
Bein



Apical



Luxators





11  
QI-03-022  
Miller-Apexo

12  
QI-03-023  
Miller-Apexo

13  
QI-03-024  
Miller-Apexo

14  
QI-03-025

15  
QI-03-026

22  
QI-03-027  
Curtis

23  
QI-03-028  
Curtis

Fig. 10  
QI-03-030  
Seldin

Fig. 1R  
QI-03-031  
Seldin

Fig. 4L  
QI-03-032  
Seldin

Fig. 4R  
QI-03-033  
Seldin

Fig. 11  
QI-03-034  
Stout

Fig. 11A  
QI-03-035  
Stout

Fig. 44C  
QI-03-036  
Stout

Fig. 10  
QI-03-029  
Miller-Apexo

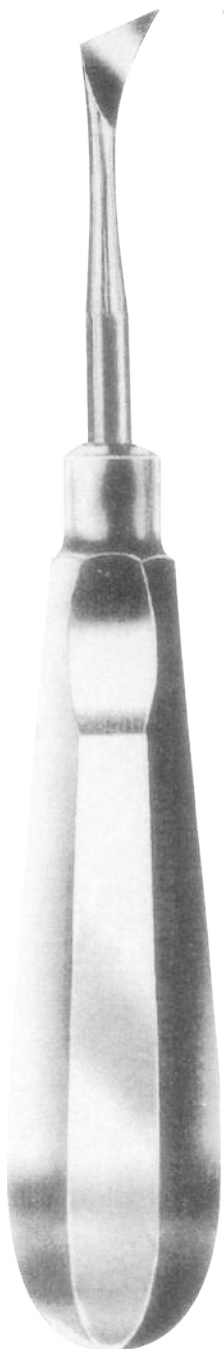


Fig . 44  
18-110-44  
Cryer



Fig . 45  
QI-03-037  
Cryer



Fig . 25  
MMI-03-038  
Cryer



Fig . 26  
MMI-03-039  
Cryer



Fig . 31  
MMI-03-040  
Cryer



Fig . 32  
MMI-03-041  
Cryer



Fig . 80  
MMI-03-042



Fig . 81  
MMI-03-043



Fig . 81A  
QI-03-045



Fig . 81E  
QI-03-046



Fig . 190  
QI-03-0467



Fig . 191  
QI-03-048



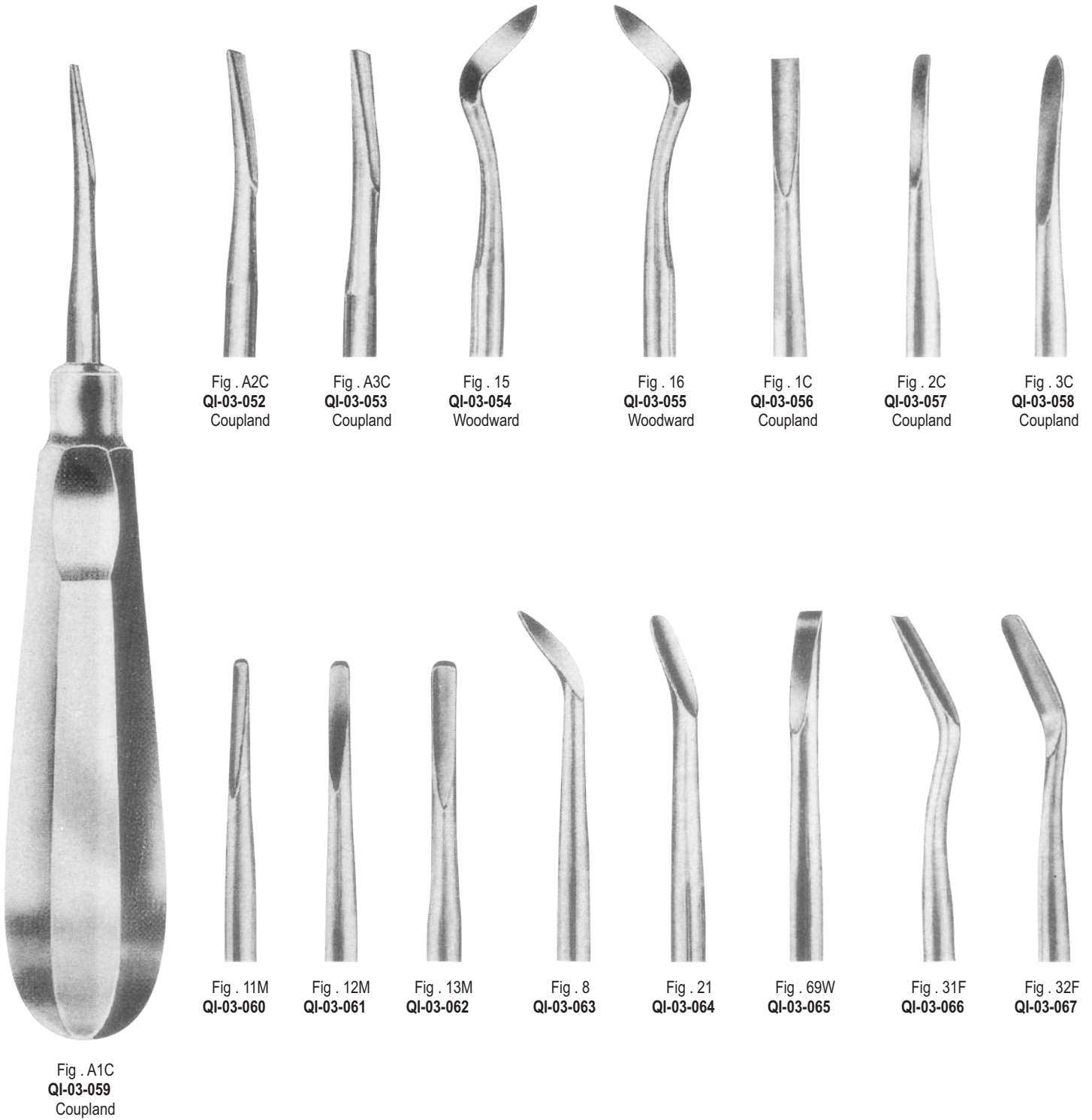
Fig . 23  
QI-03-049



Fig . 24  
QI-03-050



Fig . 98  
QI-03-051





Bein

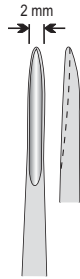


Fig. 1  
QI-03-068

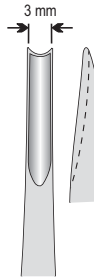


Fig. 2  
QI-03-069

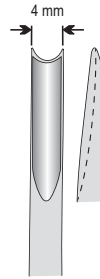


Fig. 3  
QI-03-070

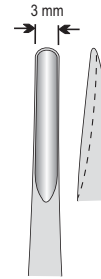


Fig. 4  
QI-03-071

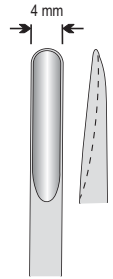


Fig. 5  
QI-03-072

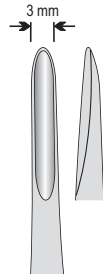


Fig. 6  
QI-03-073

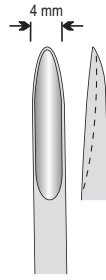


Fig. 7  
QI-03-074

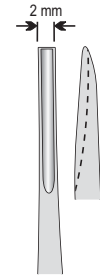


Fig. 8  
QI-03-075

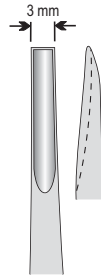


Fig. 9  
QI-03-076

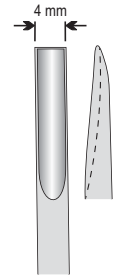


Fig. 10  
QI-03-077

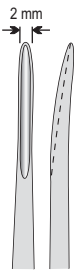


Fig. 1  
QI-03-078

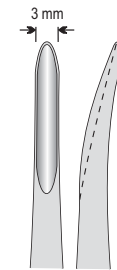


Fig. 2  
QI-03-079

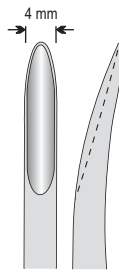


Fig. 3  
QI-03-080

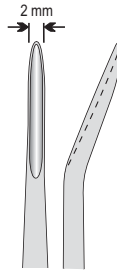


Fig. 1  
QI-03-081

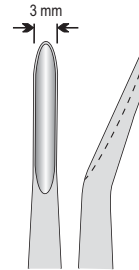


Fig. 2  
QI-03-082

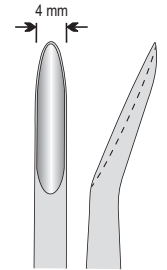


Fig. 3  
QI-03-083

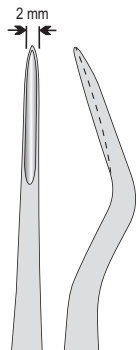


Fig. 1  
QI-03-084  
Bayonet Distal

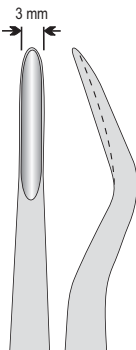


Fig. 2  
QI-03-085  
Bayonet Distal

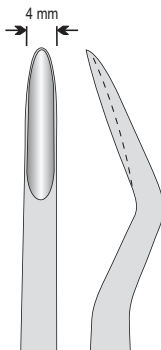


Fig. 3  
QI-03-086  
Bayonet Distal

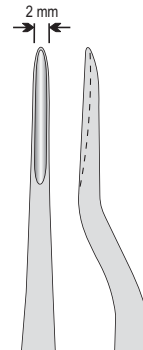


Fig. 1  
QI-03-087  
Bayonet Mesial

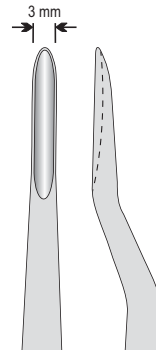


Fig. 2  
QI-03-088  
Bayonet Mesial

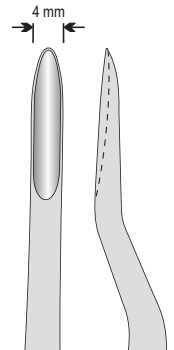
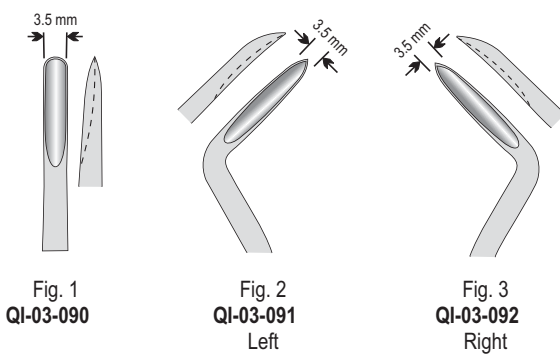


Fig. 3  
QI-03-089  
Bayonet Mesial

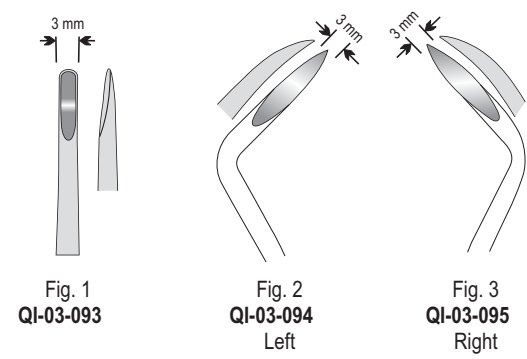




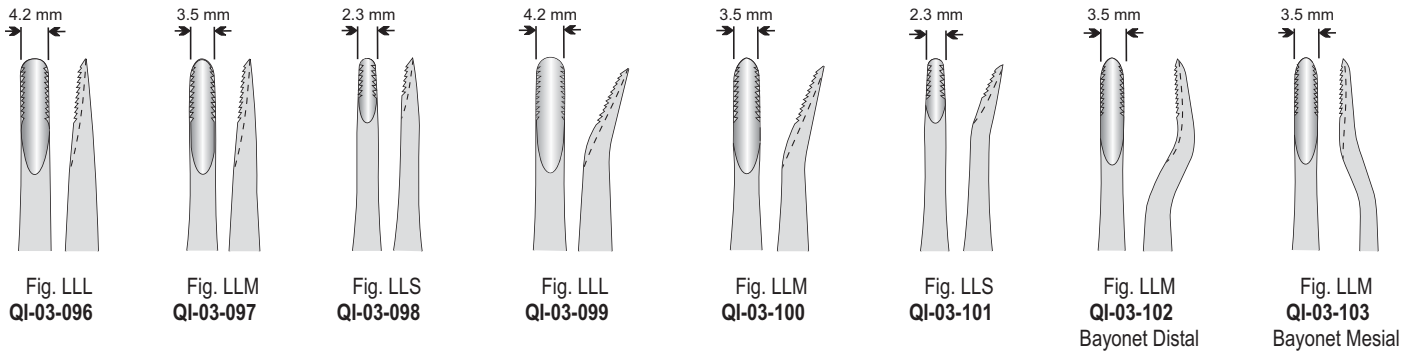
**Flohr**



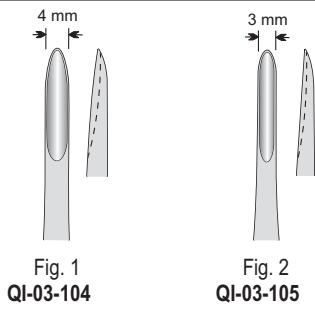
**Friedman**



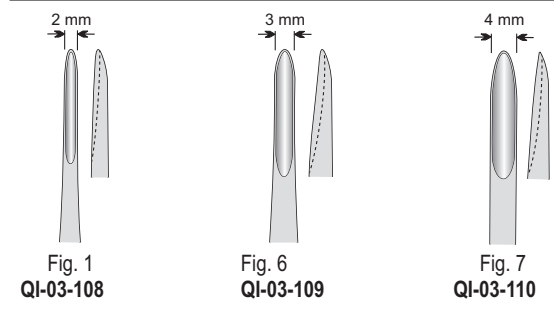
**Lindo-Levian**



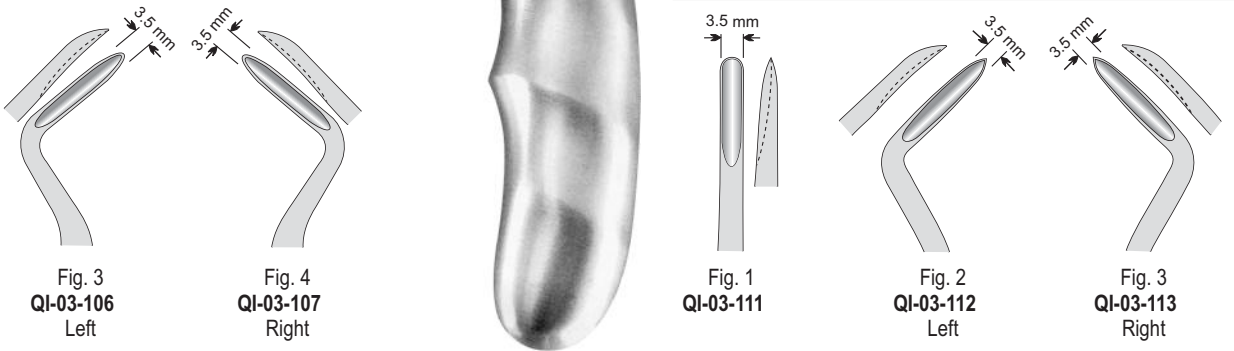
**Hysin**

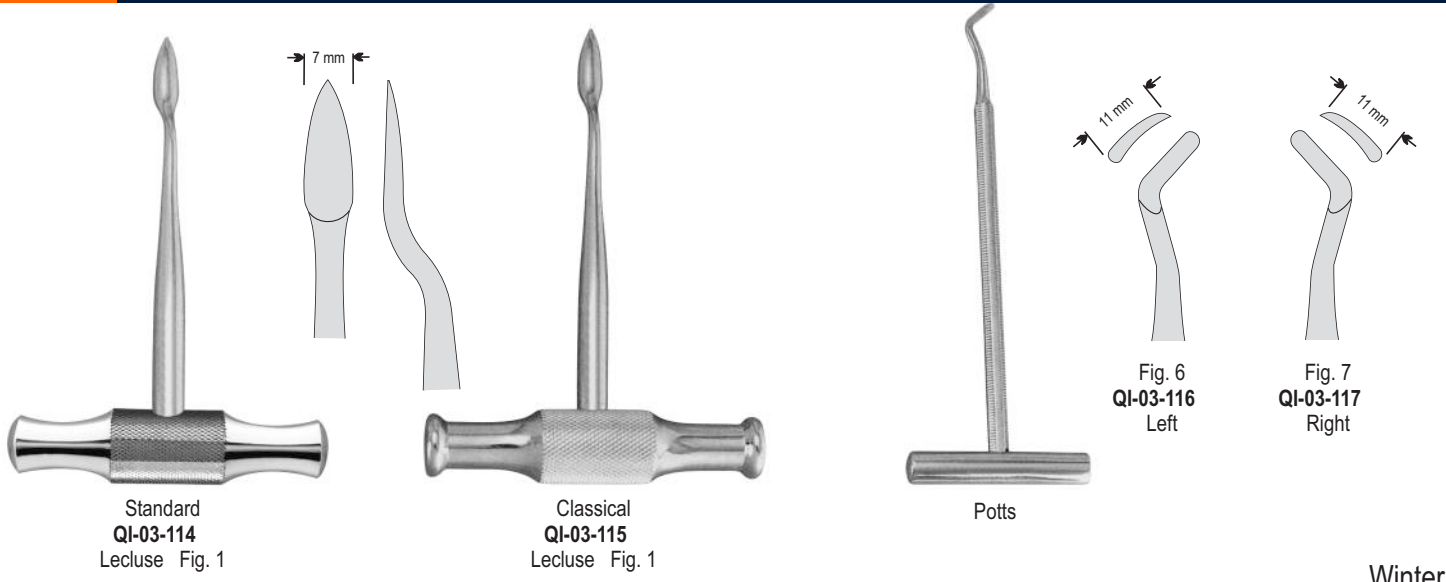


**Bein**

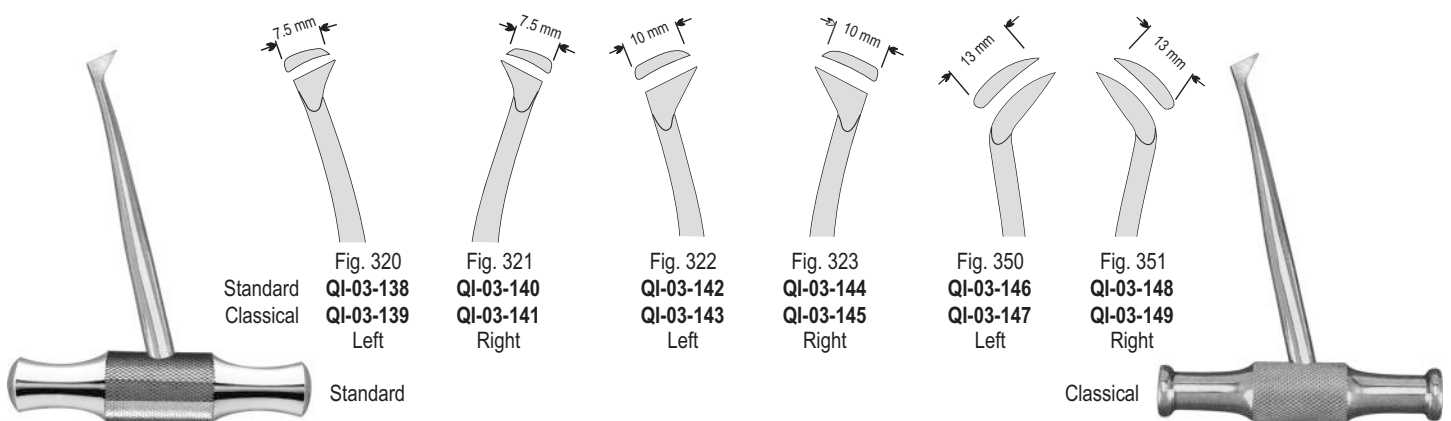
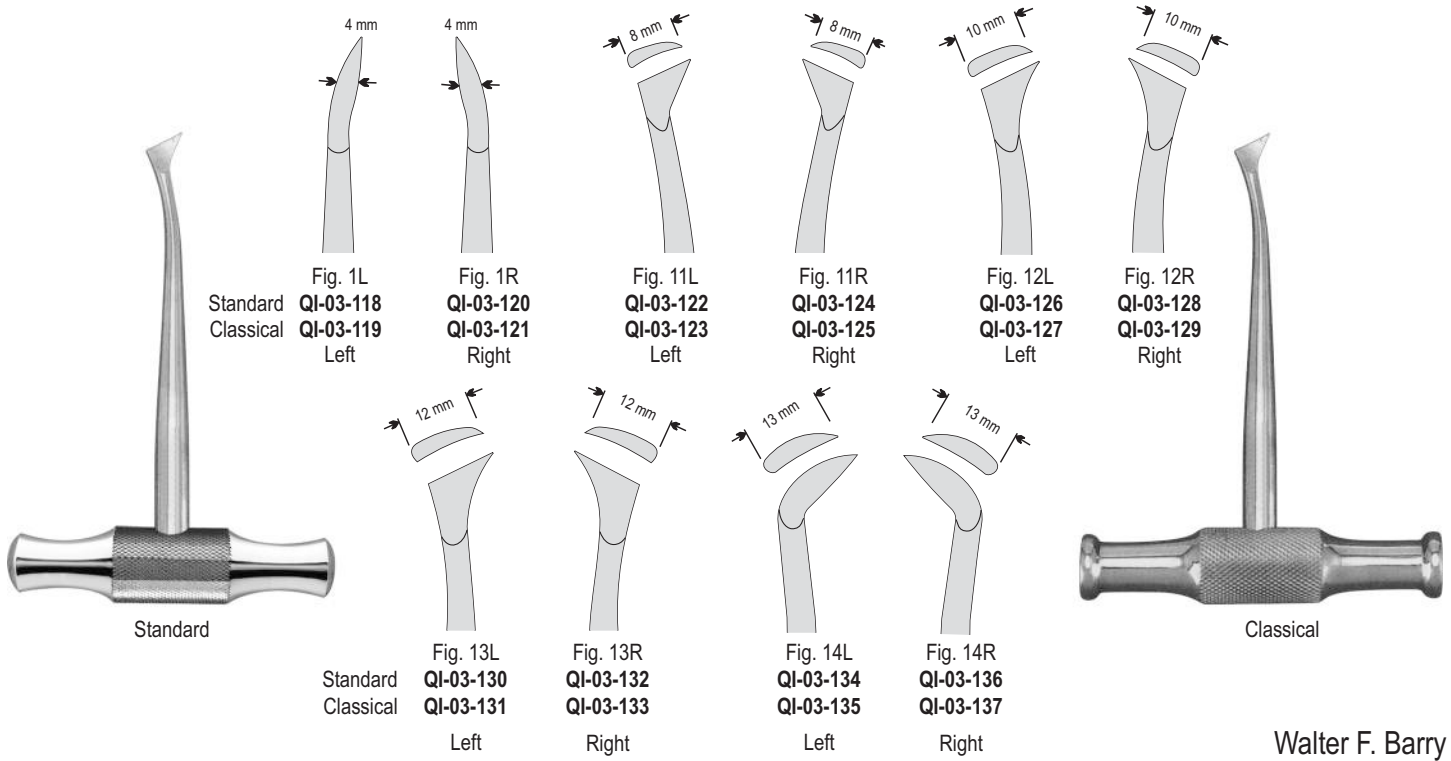


**Flohr**





Winter





04

Page 43-47

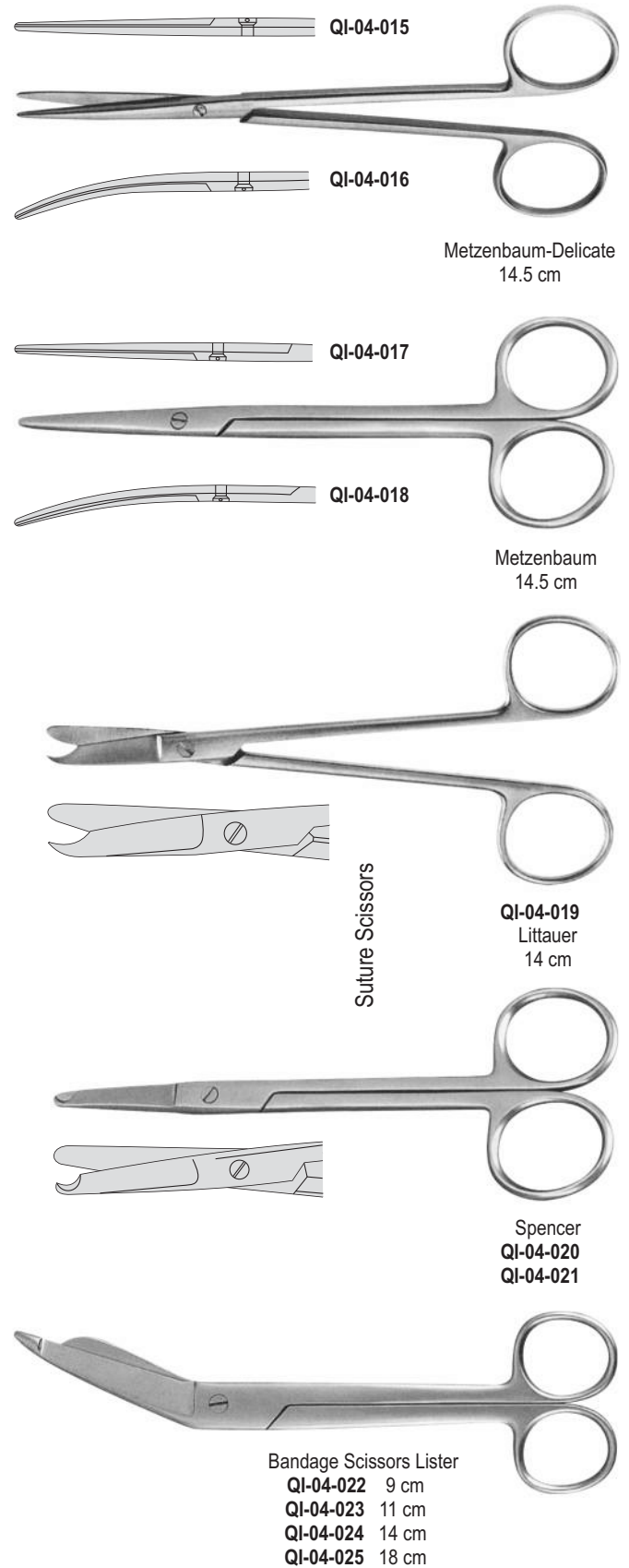
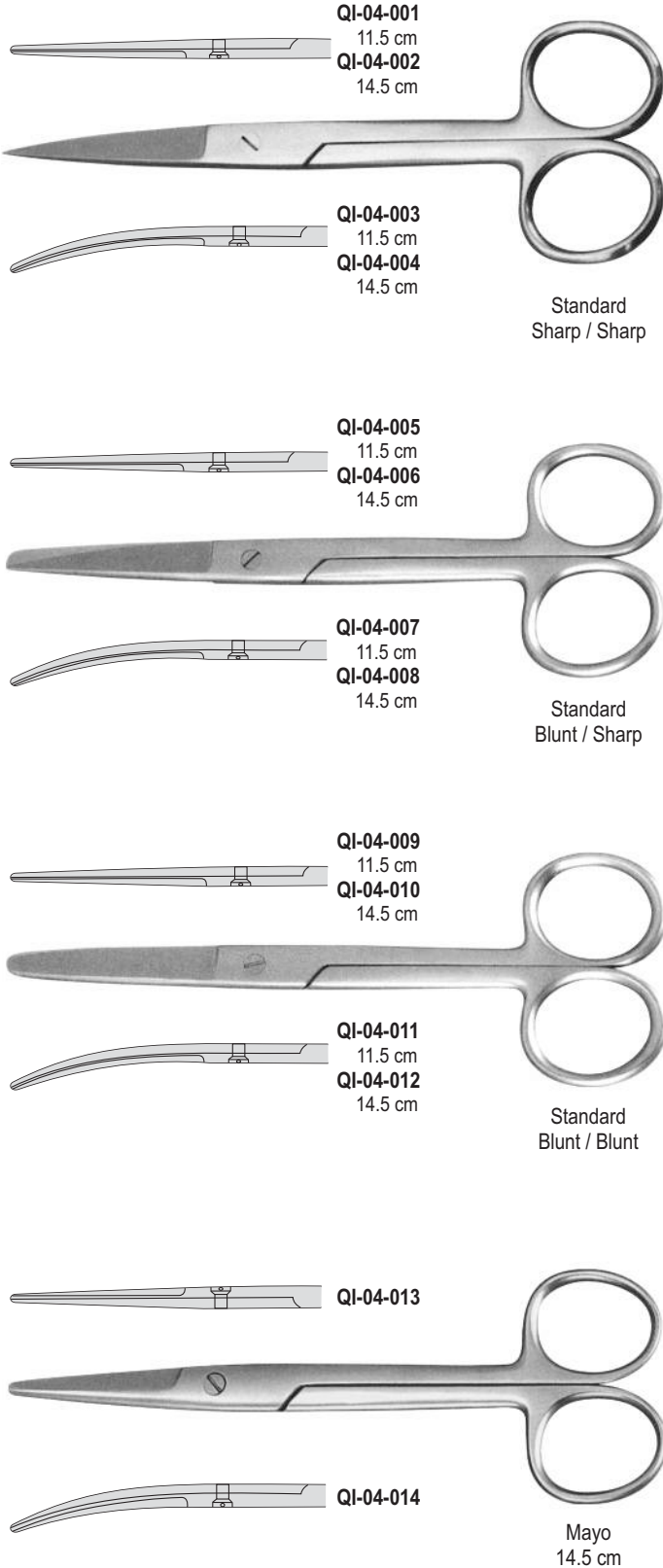
## scissors

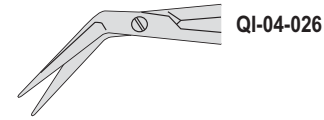
Operating Scissors

Scissors With Tungsten Carbide Inserts

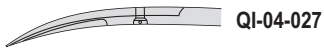
Micro Scissors

Super Cut Scissors





QI-04-026



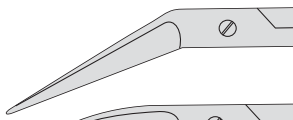
QI-04-027



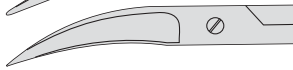
QI-04-028



Noyes / Castroviejo  
12 cm



QI-04-029



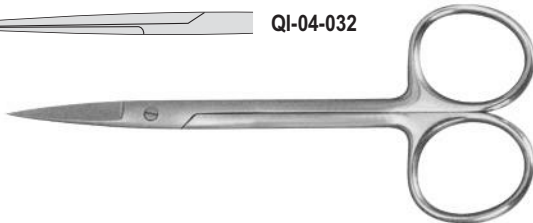
QI-04-030



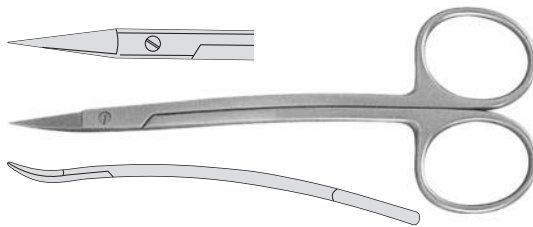
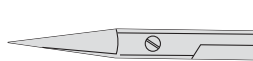
QI-04-031



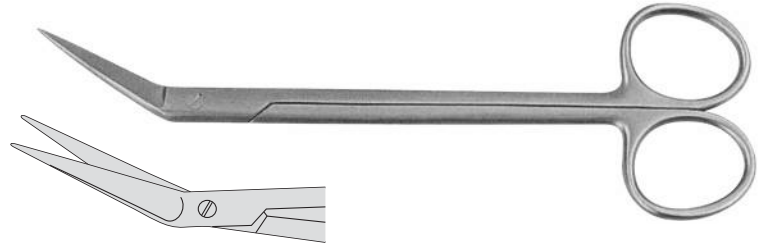
QI-04-032



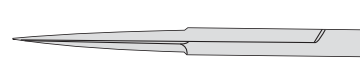
Iris  
11.5 cm



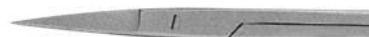
QI-04-033  
La Grange  
11.5 cm



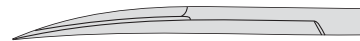
QI-04-034  
Kelly  
16 cm



QI-04-035



QI-04-036



Kelly  
16 cm



QI-04-037  
Goldman-Fox  
13 cm



QI-04-038



QI-04-039



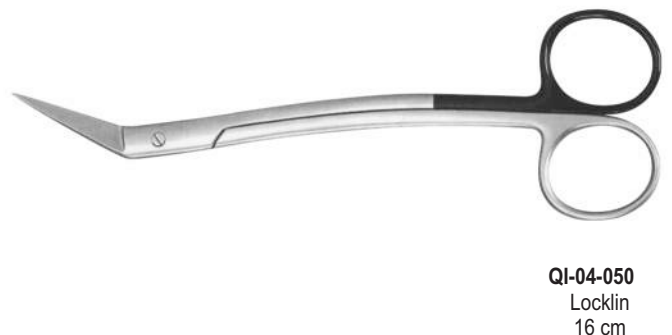
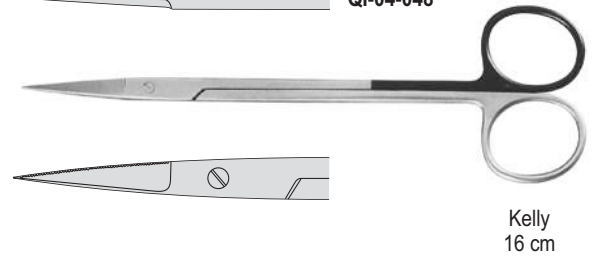
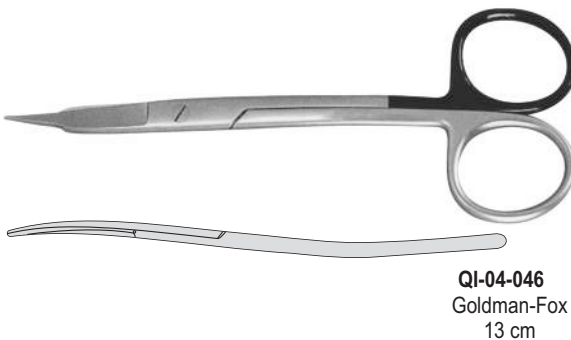
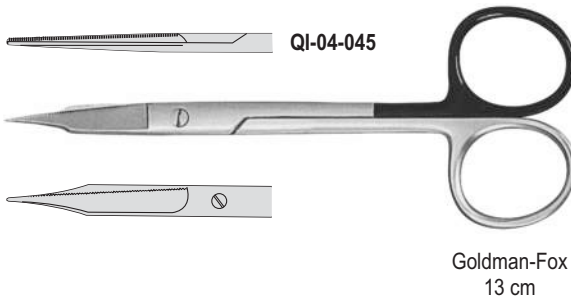
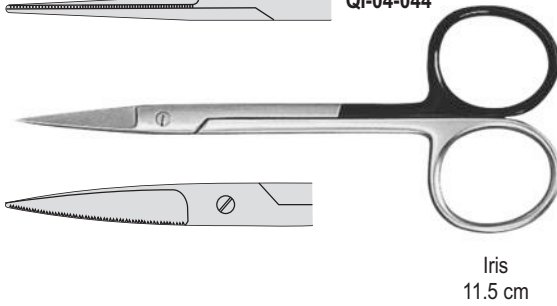
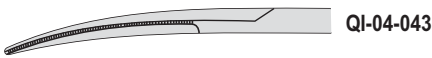
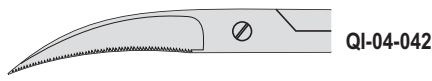
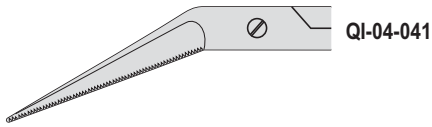
Goldman-Fox  
13 cm



QI-04-040  
Universal  
18 cm

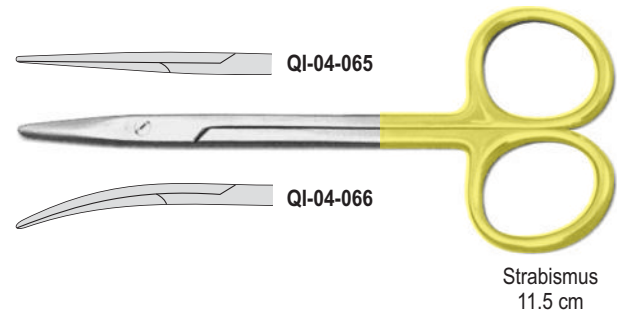
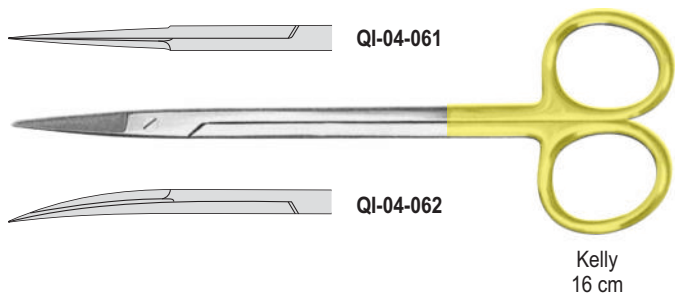
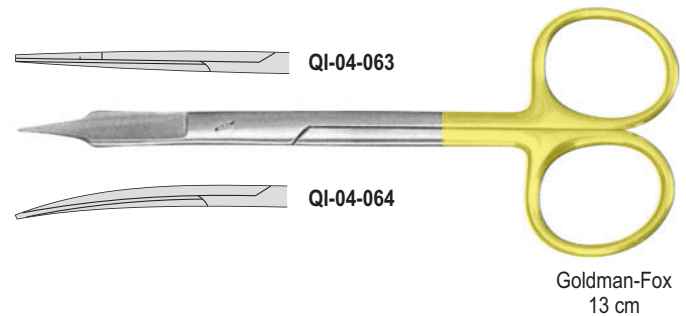
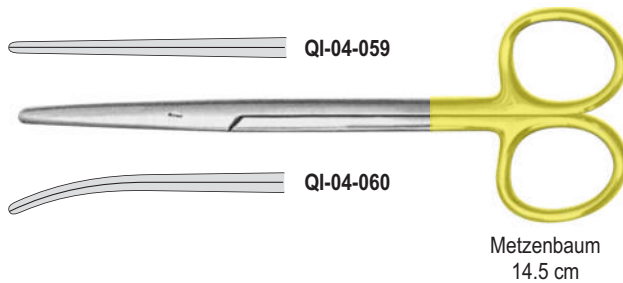
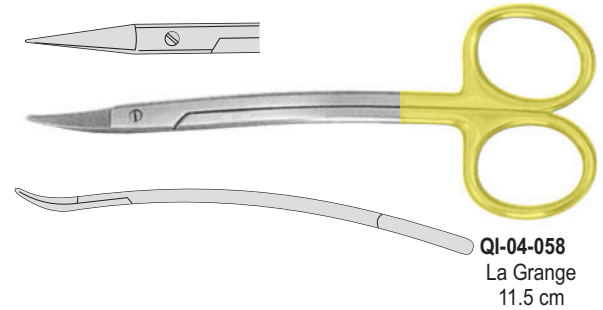
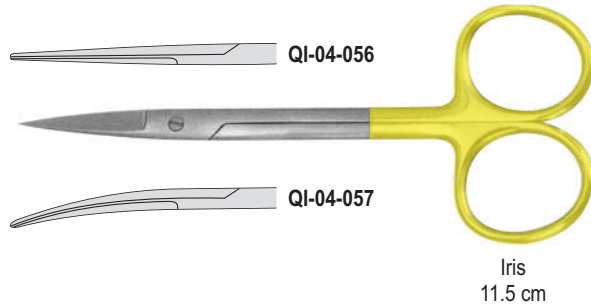
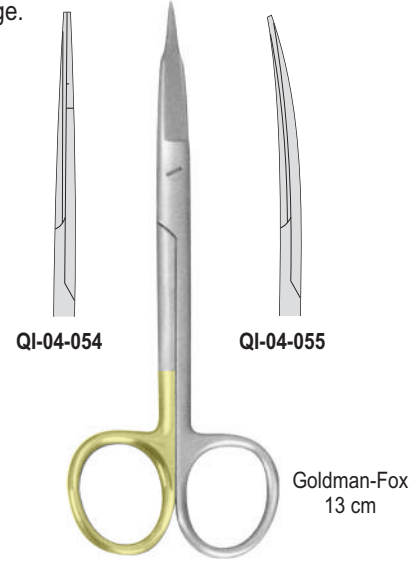
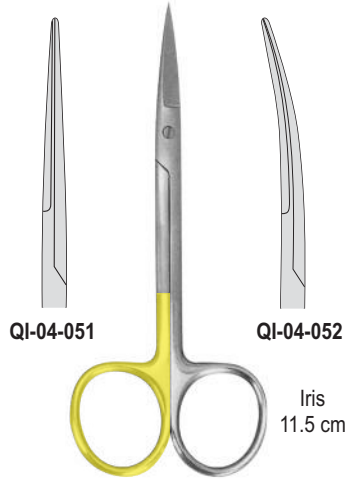
**Scissors, One Blade Serrated**

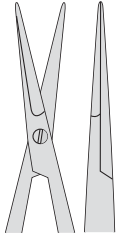
- One blade is with fine serrations to avoid tissue or ligature slippage.
- Manufactured from high quality stainless steel to provide longer-lasting cutting edge.
- Single black ring for easy identification.



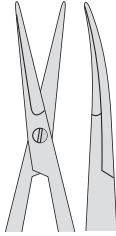
**Super-Cut**

- Cutting Blade horned to "razor" sharpness with opposing blade finished with fine serrations to avoid tissue slippage.
- Extremely smooth cutting with less trauma.
- Manufactured from high quality stainless steel to provide longer-lasting cutting edge.
- Single gold plated ring for easy identification.





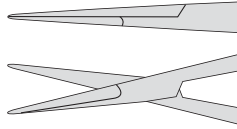
**QI-04-067**  
15 cm



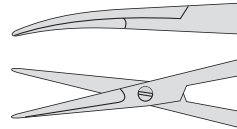
**QI-04-068**  
15 cm



Micro Scissor  
Stainless Steel



**QI-04-069**  
18 cm



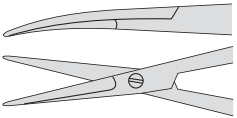
**QI-04-070**  
18 cm



Micro Scissor  
Stainless Steel

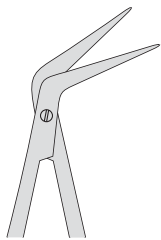


Micro Scissor  
Stainless Steel  
for ligature, one  
blade serrated

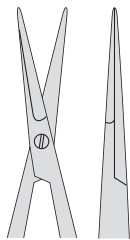


**QI-04-071**  
18 cm

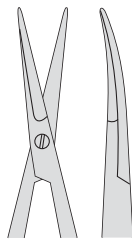
Micro Scissors with Titanium Stainless Steel Tips



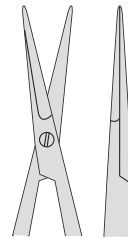
**QI-04-072**  
18 cm



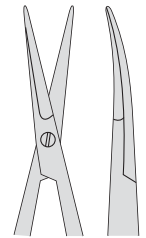
**QI-04-073**  
18 cm



**QI-04-074**  
18 cm



**QI-04-075**  
15.5 cm



**QI-04-076**  
15.5 cm





## Tweezers

Tweezers

Dressing & Dissecting Forceps

Haemostatic Forceps

Needle Holders

Needle Holders with Tungsten Carbide Inserts

Micro Needle Holders & Forceps

Tweezers



**QI-05-001**  
College  
15 cm



**QI-05-002**  
College  
15 cm

Fig. 8



**QI-05-003**  
College-Locking  
15 cm



**QI-05-004**  
Flagg  
16 cm



**QI-05-005**  
Meriam  
16 cm



**QI-05-006**  
College  
15 cm



**QI-05-007**  
Flagg  
16 cm



**QI-05-008**  
Meriam  
16 cm



**QI-05-009**  
Perry  
13 cm



**QI-05-010**  
Perry  
13 cm



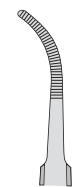
**QI-05-011**  
College TOE  
15 cm



**QI-05-012**  
Meriam TOE  
16 cm



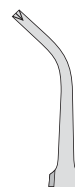
**QI-05-013**



**QI-05-014**



**QI-05-015**



**QI-05-016**

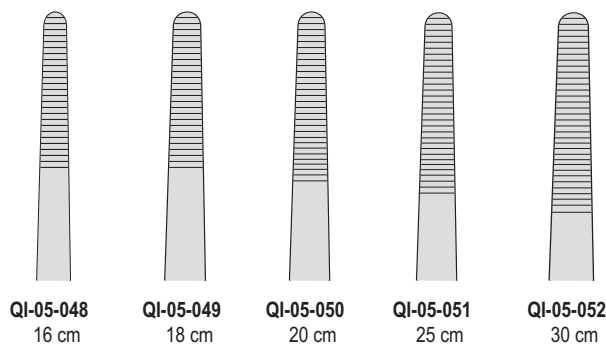
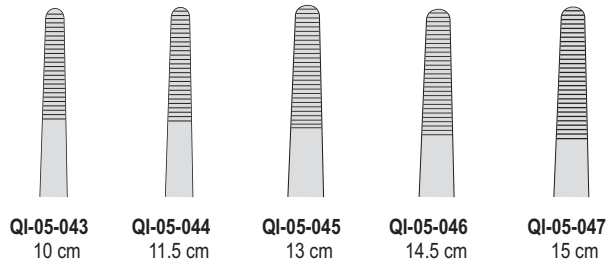


Gerald  
18 cm

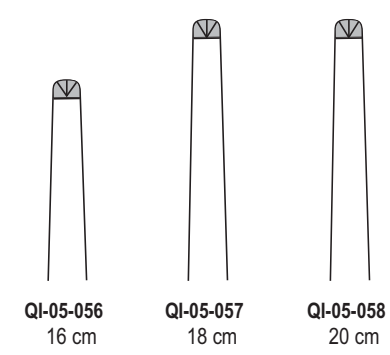
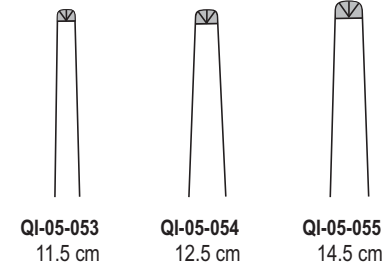


Gerald  
18 cm



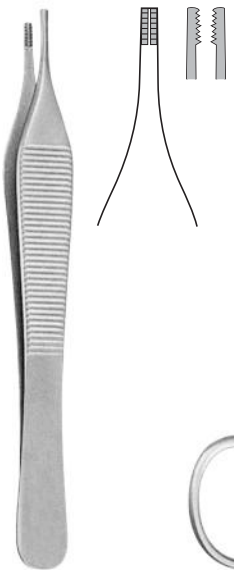


Standard Dressing Forceps



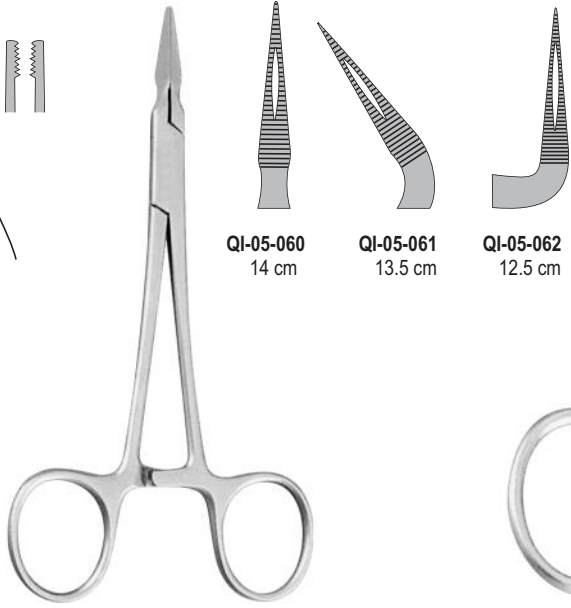
Standard Dissecting Forceps

Tissue Forceps

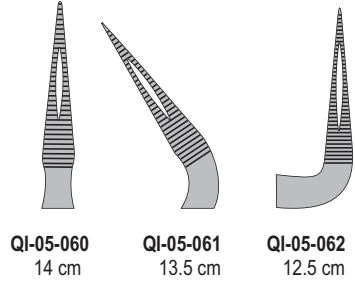


**QI-05-059**  
Adson-Brown  
12 cm

Splinter Forceps



Stieglitz



Towel Forceps



Backhaus  
**QI-05-063** 9 cm  
**QI-05-064** 11 cm  
**QI-05-065** 13 cm

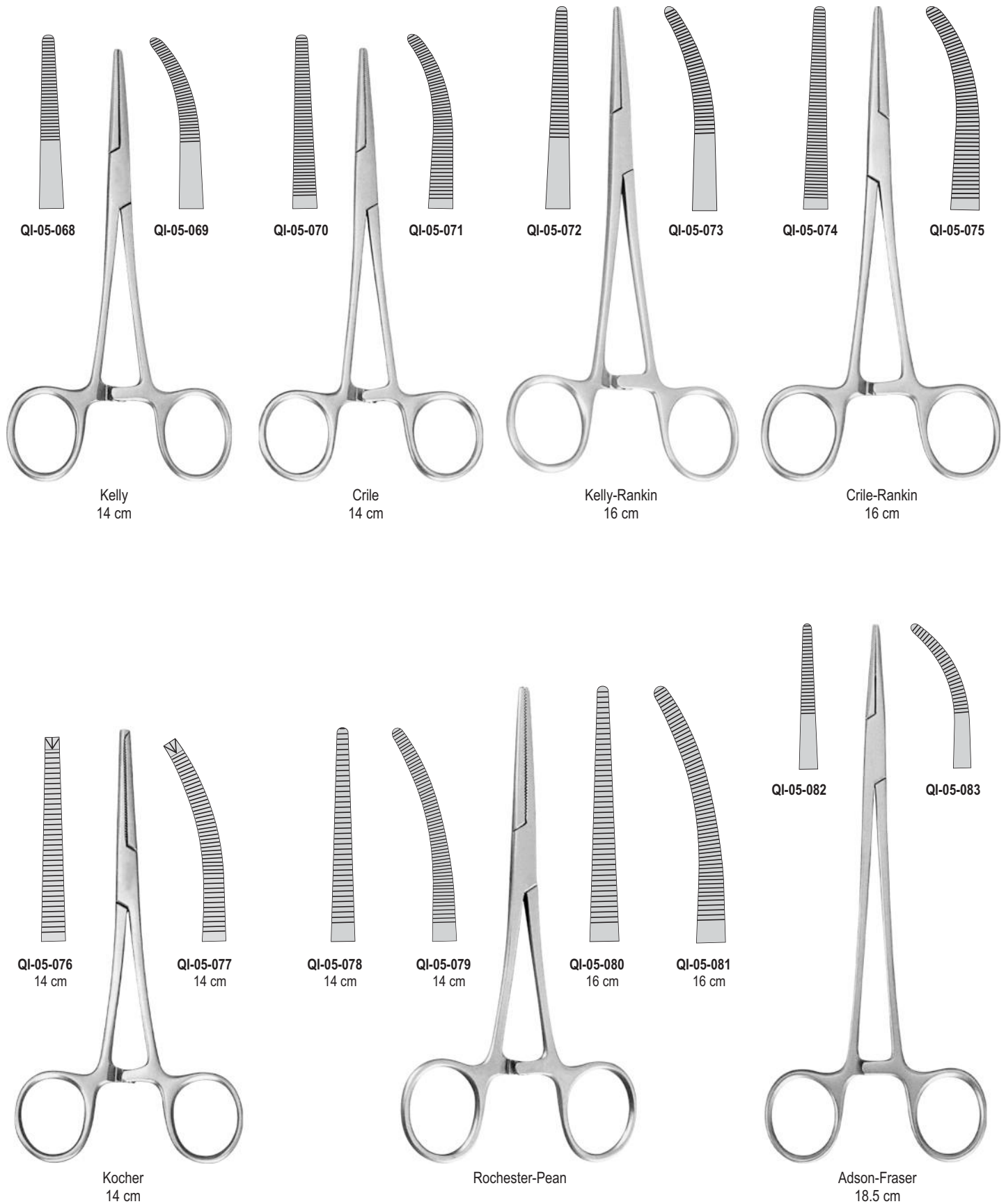


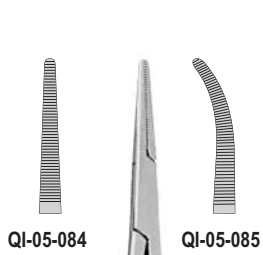
**QI-05-066**  
Jones  
9 cm



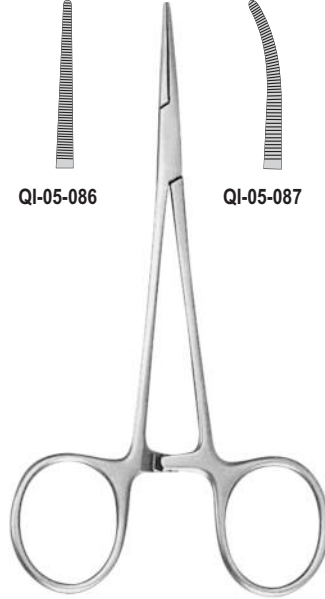
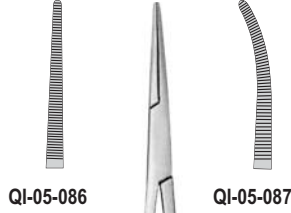
**QI-05-067**  
Schaedel  
9 cm

HAEMOSTATIC FORCEPS  
PINZA EMOSTATICA

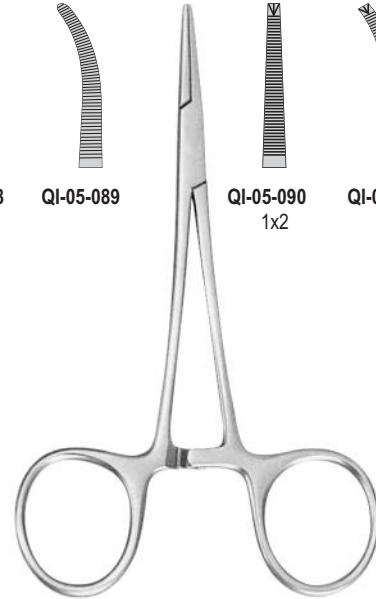
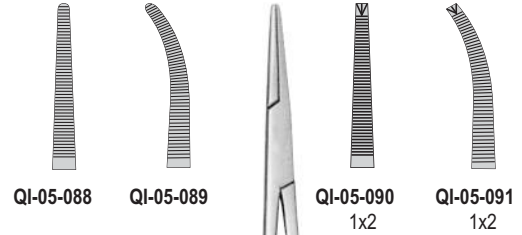




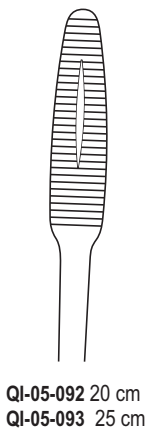
Hartman  
10 cm



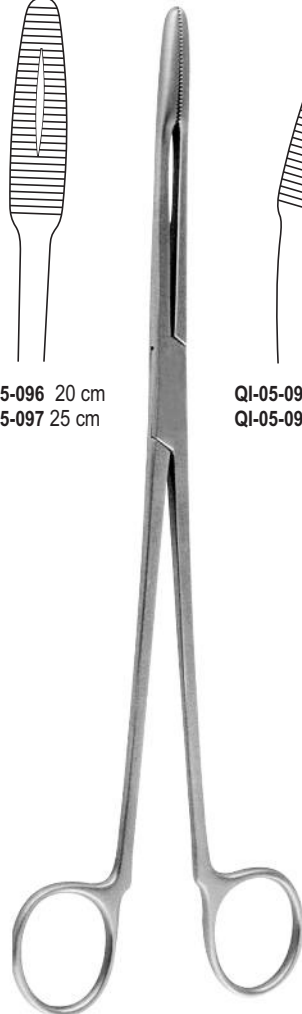
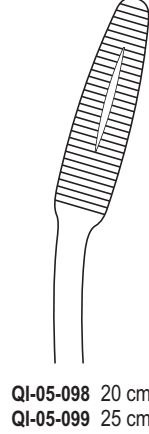
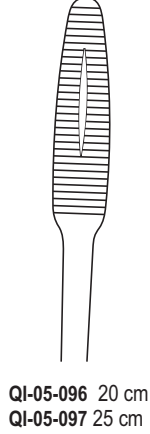
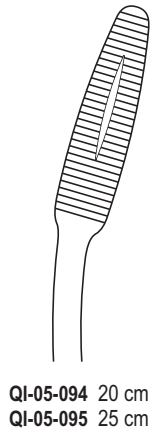
Micro Mosquito  
12.5 cm



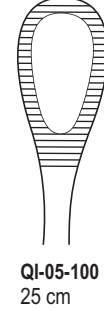
Halsted-Mosquito  
12.5 cm



Dressing Forceps  
Gross-Maier



Dressing Forceps  
Gross-Maier  
without ratchet



Sponge Forceps  
Forester



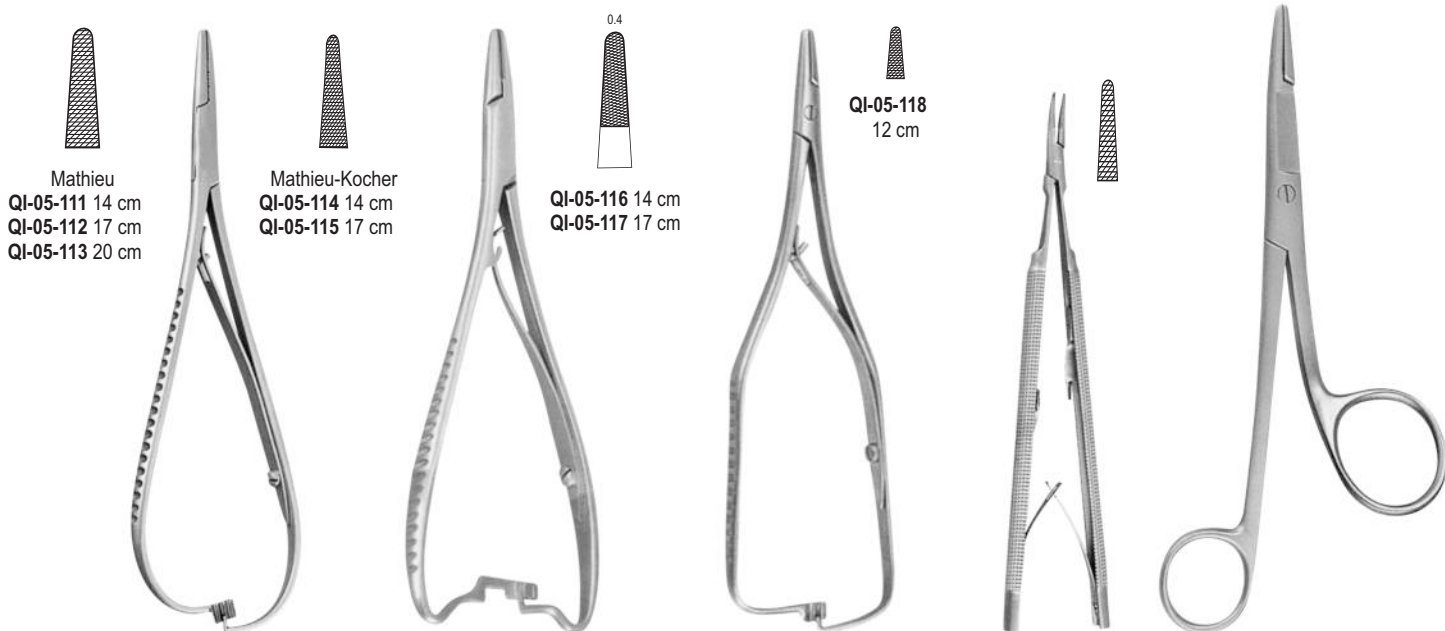
**QI-05-102**  
Derf  
12.5 cm

**QI-05-103**  
Olsen-Hegar  
with scissor  
14 cm

**QI-05-104**  
Baumgartner  
14.5 cm

**QI-05-105**  
Crilewood  
15 cm

Mayo-Hegar  
**QI-05-106** 14 cm  
**QI-05-107** 15 cm  
**QI-05-108** 16 cm  
**QI-05-109** 18 cm  
**QI-05-110** 20 cm



Mathieu  
**QI-05-111** 14 cm  
**QI-05-112** 17 cm  
**QI-05-113** 20 cm

Mathieu-Kocher  
**QI-05-114** 14 cm  
**QI-05-115** 17 cm

0.4  
**QI-05-116** 14 cm  
**QI-05-117** 17 cm

**QI-05-118**  
12 cm

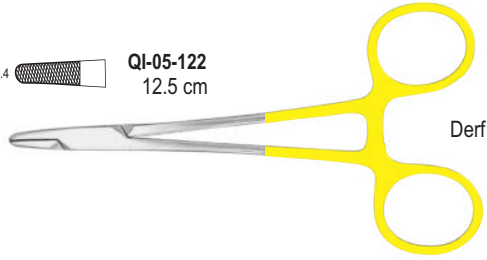
**QI-05-119**  
Castroviejo  
13 cm

Gillies with Scissor 16 cm  
**QI-05-120** Left handed  
**QI-05-121** Right handed

Mathieu

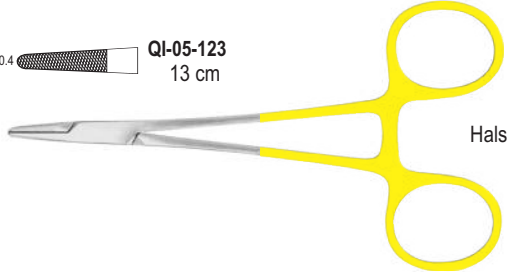
Boynton

0.4 **QI-05-122**  
12.5 cm



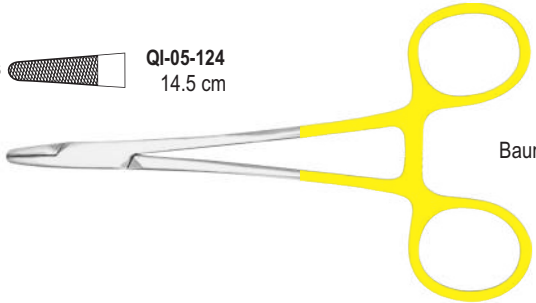
Derf

0.4 **QI-05-123**  
13 cm



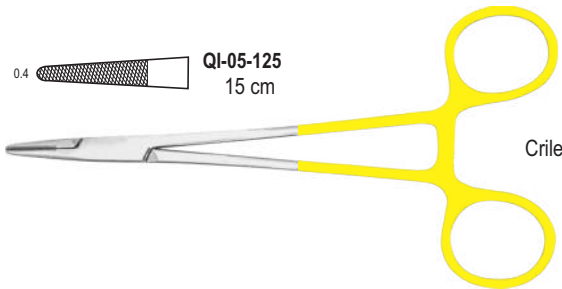
Halsey

0.5 **QI-05-124**  
14.5 cm



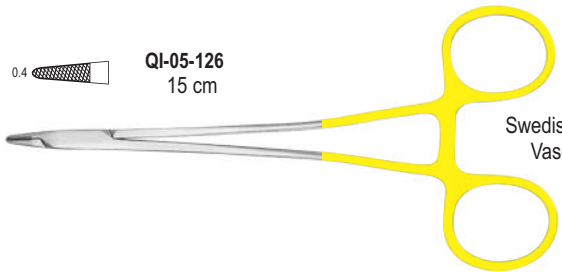
Baumgartner

0.4 **QI-05-125**  
15 cm



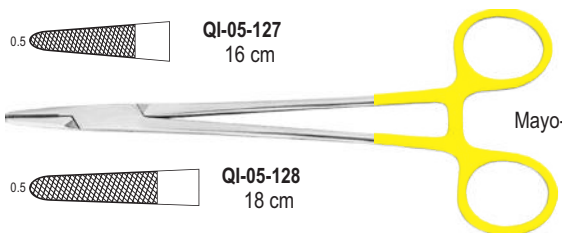
Crilewood

0.4 **QI-05-126**  
15 cm



Swedish-Micro  
Vascular

0.5 **QI-05-127**  
16 cm



Mayo-Hegar

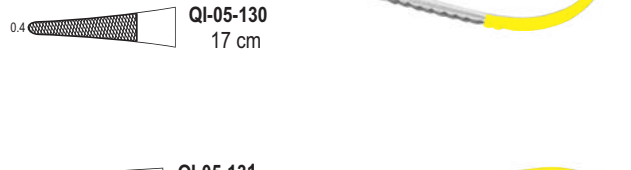
0.5 **QI-05-128**  
18 cm

0.4 **QI-05-129**  
14 cm



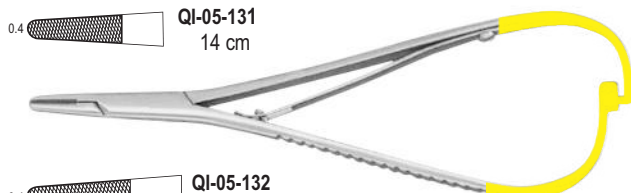
Mathieu  
Kocher

0.4 **QI-05-130**  
17 cm

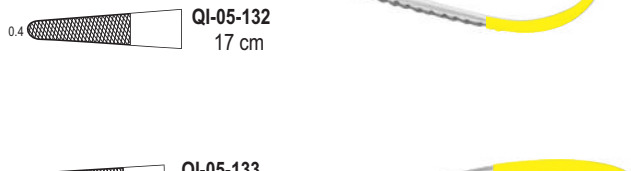


Mathieu

0.4 **QI-05-131**  
14 cm



0.4 **QI-05-132**  
17 cm



Mathieu

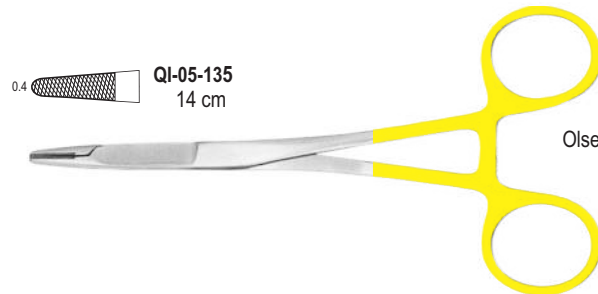
0.4 **QI-05-133**  
14 cm



0.4 **QI-05-134**  
17 cm



0.4 **QI-05-135**  
14 cm



Olsen-Hegar

0.5 **QI-05-136**  
18 cm



Toennis



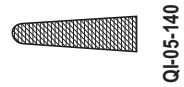
Needle Holders with Tungsten Carbide inserts



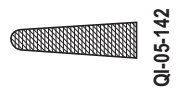
Castroviejo  
14 cm



Castroviejo  
14 cm



Castroviejo  
14 cm



Castroviejo  
14 cm



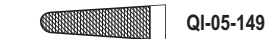
Castroviejo  
14 cm



Castroviejo  
14 cm



Castroviejo  
14 cm

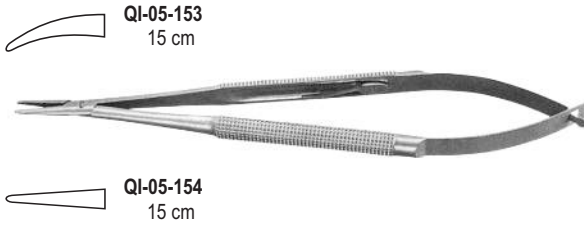


Castroviejo  
14 cm

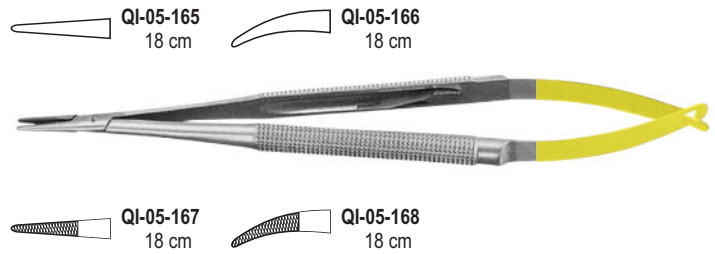
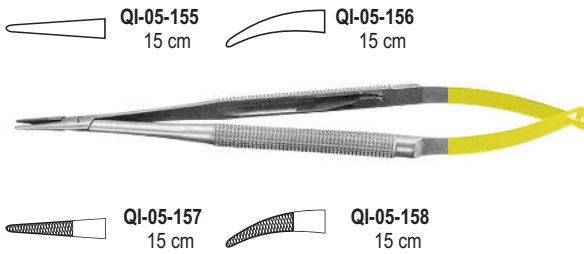


Castroviejo  
18 cm

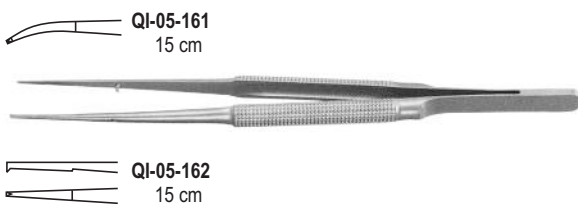
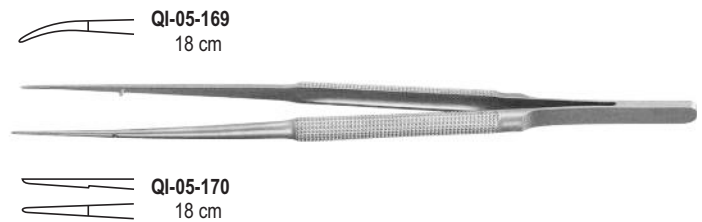
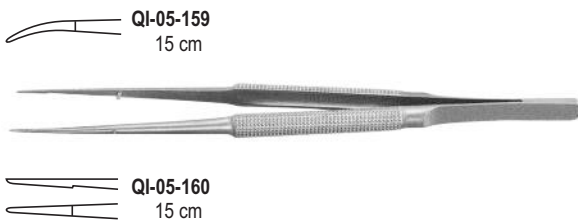
Micro Needle Holders Stainless Steel



Micro Needle Holders Stainless Steel  
with Tungsten Carbide Inserts



Micro Forceps Stainless Steel





06

Page 57-77

## Implantology instruments & Mouth Gags

Mouth Gags

Tongue Depressors

Lips & Cheek Retractors

Retractors & Forceps

Bone Instruments & Mallets

Implantology Instruments

Periosteal Elevators

Periodontal Instruments

Bone Curettes

Files

Surgery Instruments



**QI-06-001**  
Heister  
Maunder Wood  
9.5 cm



**QI-06-002**  
Obwegeser 11 cm  
Spreading 47 mm



**QI-06-003**  
Heister  
13 cm



Molt  
**QI-06-004** 10 cm  
**QI-06-005** 11 cm  
**QI-06-006** 14 cm



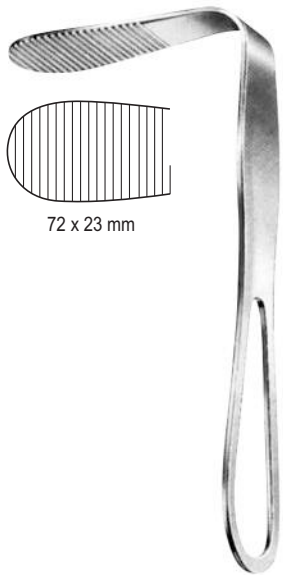
Roser-Konig  
**QI-06-007** 16 cm  
**QI-06-008** 19 cm



**QI-06-009**  
Denhardt  
13 cm



**QI-06-010**  
Fergusson - Ackland  
14.5 cm



72 x 23 mm

**QI-06-011**  
Hartmann  
15 cm



**QI-06-012**  
Doyen Tongue Spatula  
13.5 cm



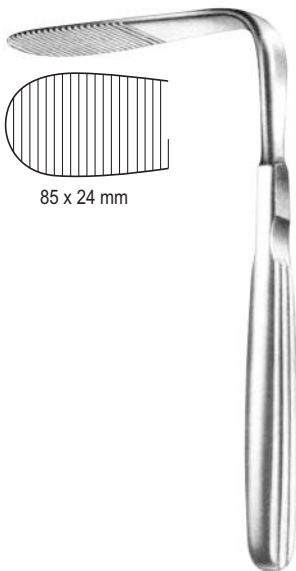
**QI-06-013**  
14.5 cm



**QI-06-014**  
18 cm

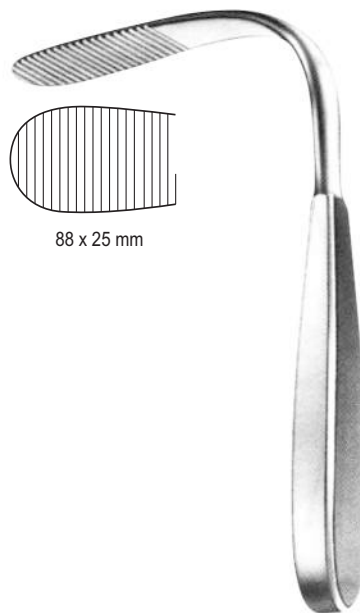


**QI-06-015**  
Bruenings  
19 cm



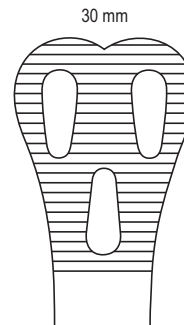
85 x 24 mm

**QI-06-016**  
Tobold  
15 cm

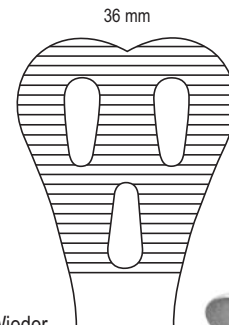


88 x 25 mm

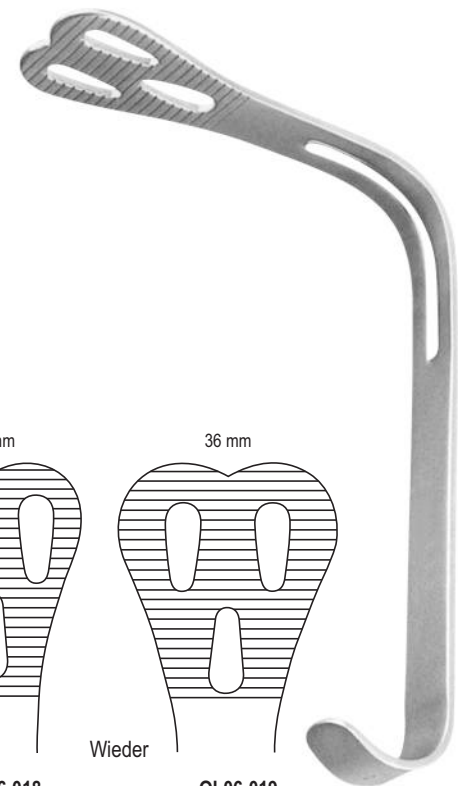
**QI-06-017**  
Tobold  
16 cm



**QI-06-018**  
14 cm



**QI-06-019**  
15 cm



Wieder



**QI-06-020**  
Obwegeser Chin  
Retractor  
16.5 cm



Obwegeser 16 cm  
**QI-06-021** 8 mm  
**QI-06-022** 10 mm



**QI-06-023** 43 x 11 mm  
**QI-06-024** 57 x 11 mm  
**QI-06-025** 83 x 16 mm



35 x 11 mm

**QI-06-026**  
Obwegeser  
Spina-nasalis retractor  
22 cm



72 x 11 mm

**QI-06-027**  
Obwegeser  
Ramus retractor for  
separation of ramus & tissue  
22 cm



**QI-06-028**  
Simplex  
10.5 cm



30x19 mm

33x25 mm

**QI-06-029**  
Kilner  
15 cm



**QI-06-030**  
Minnesota  
14 cm



**QI-06-031**  
Cawood-Minnesota  
15 cm



**QI-06-032**  
Austin

LIPS & CHEEK RETRACTORS  
 DIVARICATORI PER LABBRA E GUANCE



**QI-06-033**  
 Hilger  
 Fits any simple stem mouth mirror handle



**QI-06-034**  
 Hilger  
 with handle



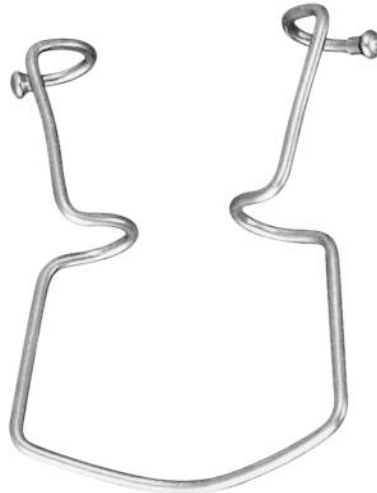
**QI-06-035**  
 20 cm

Finger protectors



Langenbeck

**QI-06-036** Small  
**QI-06-037** Medium  
**QI-06-038** Large



**QI-06-039**  
 Oringer  
 11.5 cm



**QI-06-040**  
 Obwegeser Cheek Retractor  
 12cm



**QI-06-041**  
 Columbia  
 14.5 cm



Sternberg

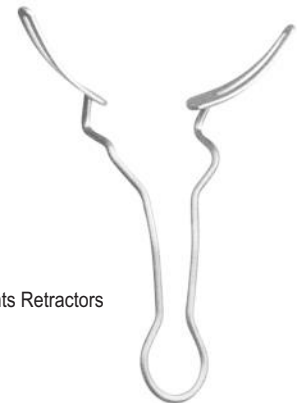
**QI-06-042** 12 cm  
**QI-06-043** 14 cm  
**QI-06-044** 15 cm



Vestibulum  
**QI-06-045**



**QI-06-046**  
 MRU

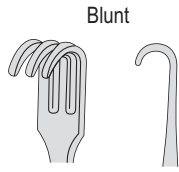


Implants Retractors

**QI-06-047**  
 MRU



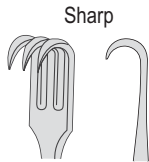
Senn-Miller  
16 cm



Blunt



QI-06-048



Sharp



QI-06-049

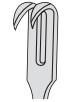


J & W  
16 cm

Sharp



QI-06-050



QI-06-051



QI-06-052



QI-06-053



J & W  
16 cm

Blunt



QI-06-054



QI-06-055



QI-06-056



QI-06-057



QI-06-058  
Collin Tongue holding forcep  
17 cm



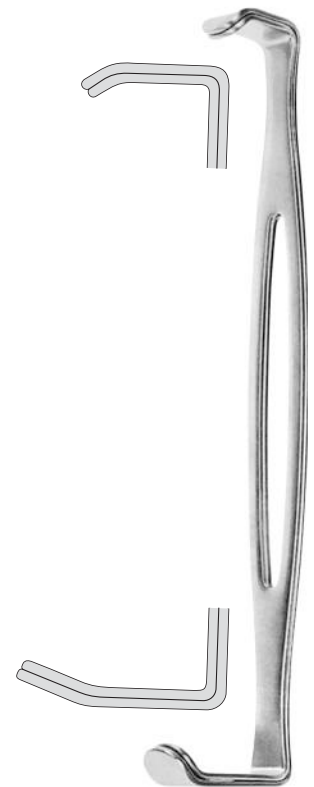
Young Tongue holding forcep  
QI-06-059 15 cm  
QI-06-060 17 cm



60-178-00  
Rubber Pad pair



QI-06-061  
Farabeuf 12 cm  
Pair

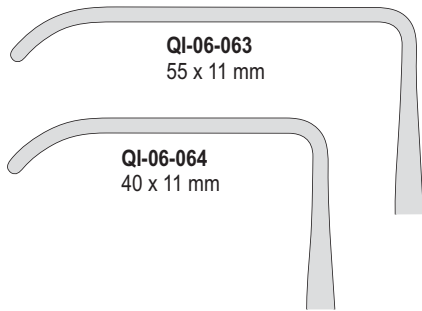


QI-06-062  
Parker-Langenbeck 21 cm  
Pair



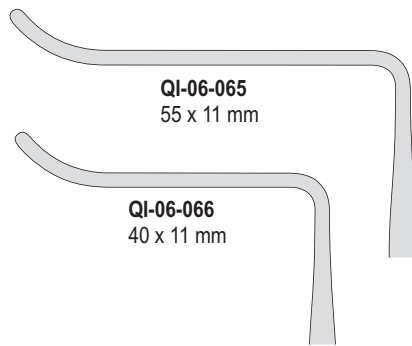


Kocher  
21.5 cm



■ QI-06-063  
55 x 11 mm

● QI-06-064  
40 x 11 mm

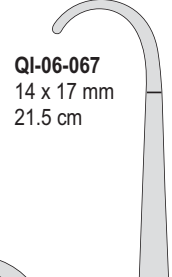
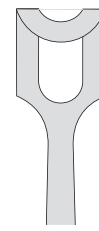


■ QI-06-065  
55 x 11 mm

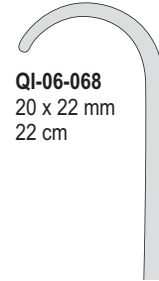
● QI-06-066  
40 x 11 mm



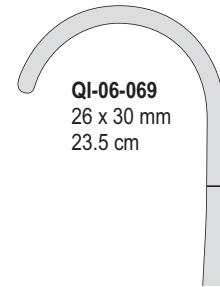
Middeldorph



■ QI-06-067  
14 x 17 mm  
21.5 cm



● QI-06-068  
20 x 22 mm  
22 cm



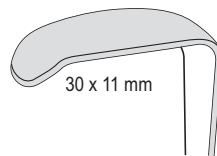
■ QI-06-069  
26 x 30 mm  
23.5 cm



■ Langenbeck  
22 cm

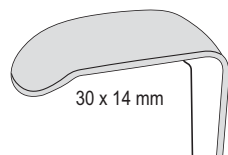


● Langenbeck  
22 cm



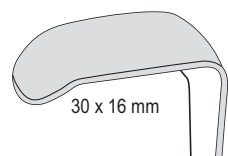
30 x 11 mm

■ QI-06-070  
● QI-06-075



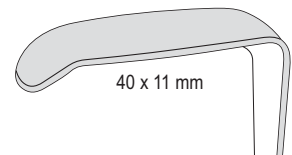
30 x 14 mm

■ QI-06-071  
● QI-06-076



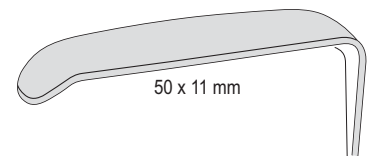
30 x 16 mm

■ QI-06-072  
● QI-06-077



40 x 11 mm

■ QI-06-073  
● QI-06-078



50 x 11 mm

■ QI-06-074  
● QI-06-079



**QI-06-080**  
Neukam  
Only Frame for Mouth Gag



Fig. 1  
**QI-06-081**  
Fig. 2  
**QI-06-082**  
Fig. 3  
**QI-06-083**

Tongue Depressors  
fenestrated blade for suction

**QI-06-084**  
Neukam  
Complete, with frame & 3 tongue depressors



**QI-06-085**  
Kilner-Doughty  
Only Frame for Mouth Gag  
14.5 cm



**QI-06-086**  
Palate plate

Fig. 1  
**QI-06-087**  
68 x 30 mm  
Fig. 2  
**QI-06-088**  
77 x 34 mm  
Fig. 3  
**QI-06-089**  
82 x 39 mm



Kilner-Doughty  
Tongue Depressors  
fenestrated blade for suction

**QI-06-090**  
Kilner-Doughty  
Complete, with frame, 3 tongue depressors,  
2 tooth plates & 1 palate plate



Davis-Boyle Tongue Depressors  
With fixed suction tube

Fig. 1  
**QI-06-091**  
110 x 28 mm



Fig. 2  
**QI-06-092**  
95 x 27 mm



Fig. 3  
**QI-06-094**  
80 x 27 mm



Fig. 4  
**QI-06-093**  
65 x 26 mm



Fig. 5  
**QI-06-095**  
30 x 20 mm  
Without Suction Tube



**QI-06-096**  
Frame for Mouth Gag with joint  
14.5 cm

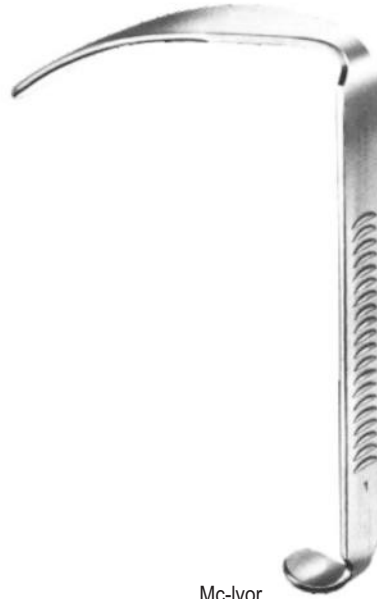
**QI-06-097**  
Frame for Mouth Gag

**QI-06-098**  
Silicone inlay  
14.5 cm

**QI-06-099**  
Davis-Boyle  
Complete, consisting of frame  
& 5 tongue depressors No. 1 to 5



**QI-06-100**  
Mc-Ivor  
Frame for Mouth Gag



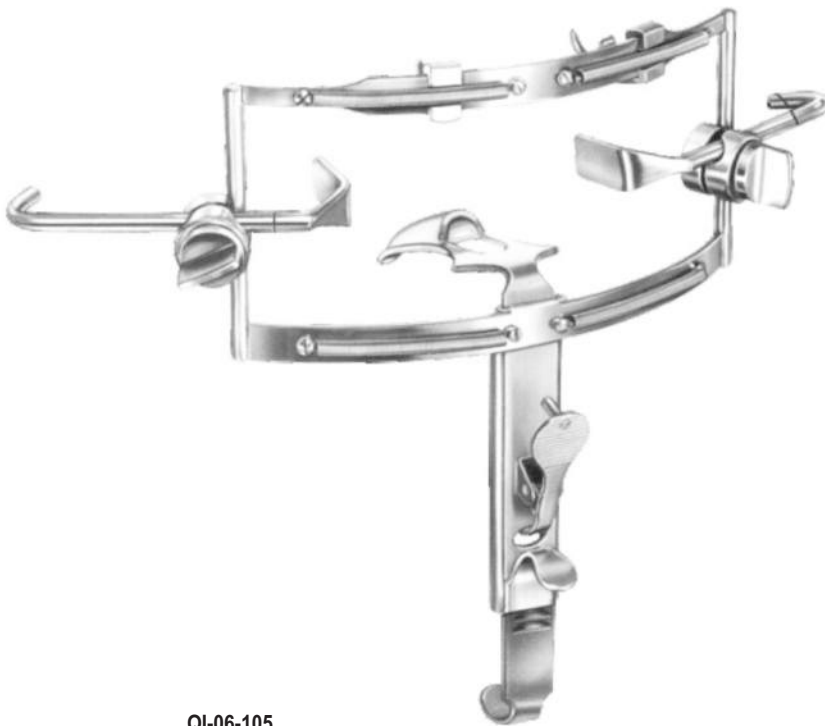
Mc-Ivor  
Tongue Depressors

Fig. 1  
**QI-06-101**  
100 x 25 mm

Fig. 2  
**QI-06-102**  
85 x 25 mm

Fig. 3  
**QI-06-103**  
75 x 25 mm

**QI-06-104**  
Mc-Ivor  
Complete, with 3 tongue depressors



**QI-06-105**  
Dingmann  
Complete, with frame, 3 tongue depressors,  
& 2 adjustable lateral blades



Dingmann  
Tongue Depressors

Fig. 1  
**QI-06-106**  
62 x 26 mm

Fig. 2  
**QI-06-107**  
65 x 30 mm

Fig. 3  
**QI-06-108**  
78 x 32 mm



Jennings  
**QI-06-109** 10.5 cm  
**QI-06-110** 12.5 cm  
**QI-06-111** 14.5 cm  
**QI-06-112** 16.5 cm

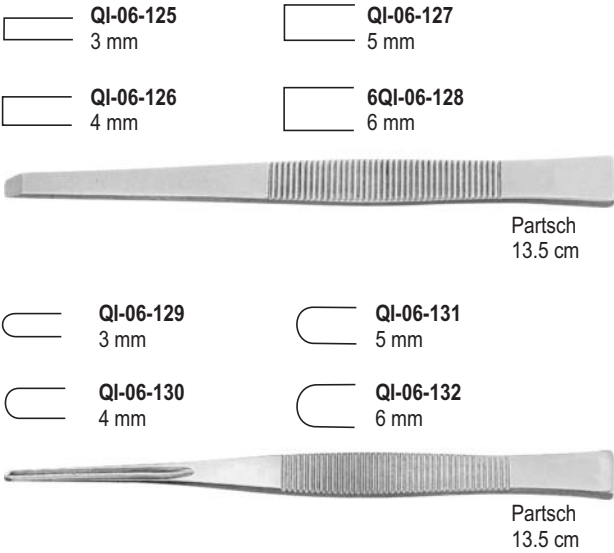
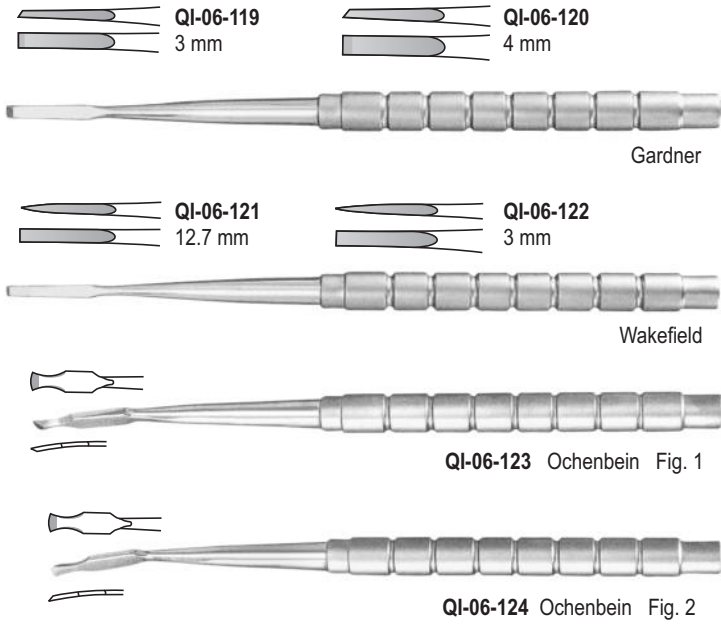


Whitehead Mouth Gag  
**QI-06-113** 11cm  
**QI-06-114** 13cm  
**QI-06-115** 15cm

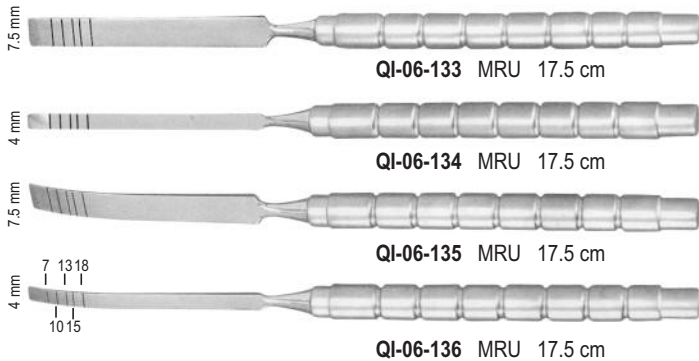


Cheek Retractor  
**QI-06-116** Small  
**QI-06-117** Medium  
**QI-06-118** Large

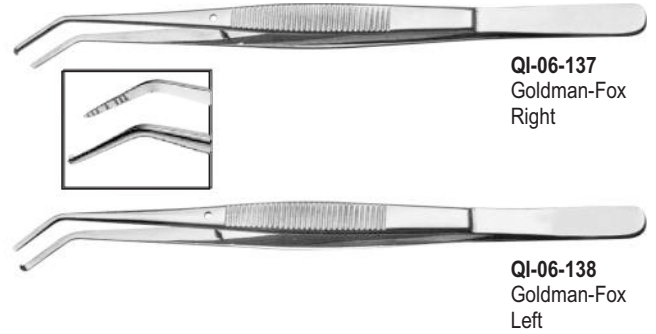
Chisels & Gouges



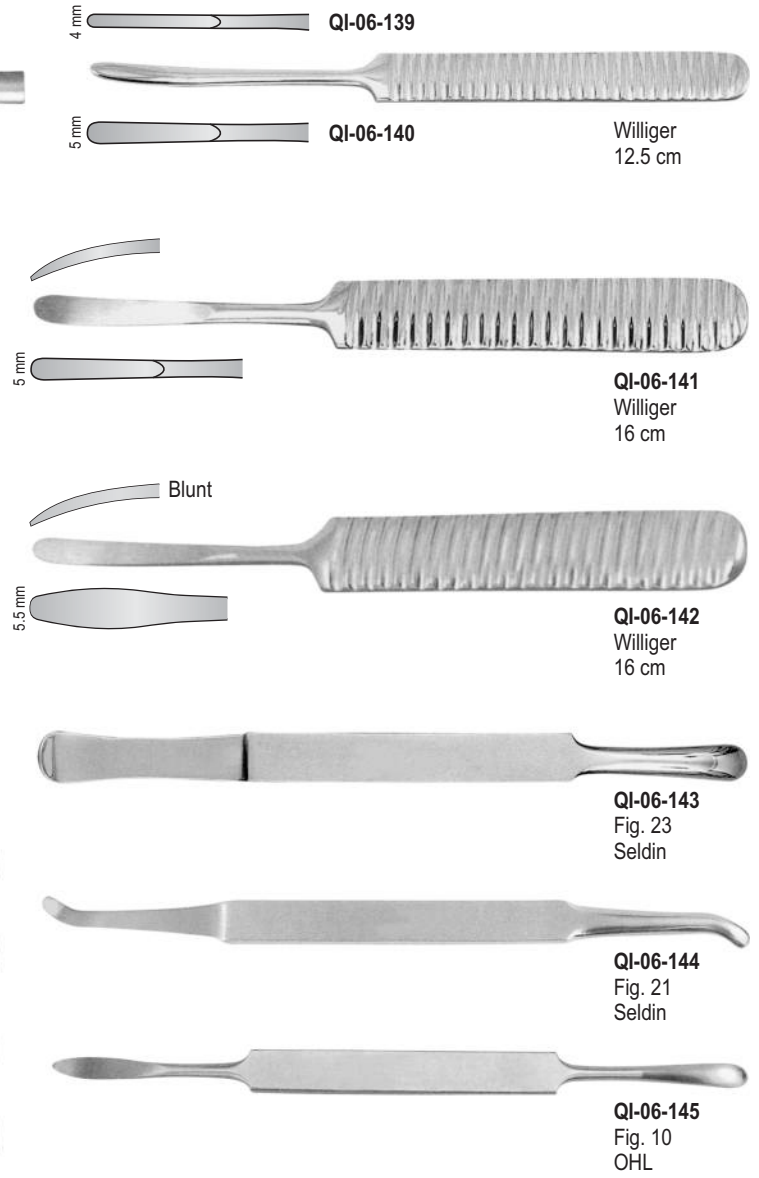
Osteotomes



Pocket Markers



Elevators & Raspatories



Osteotomes

# 1	Diam.
0	Ø 1.60
7.5	Ø 1.80
10	Ø 2.00
13.5	Ø 2.40
15.5	Ø 3.60

# 2	Diam.
0	Ø 1.90
7.5	Ø 2.20
10	Ø 2.35
13.5	Ø 3.30
15.5	Ø 3.40
23.5	Ø 4.50

# 3	Diam.
0	Ø 2.80
7.5	Ø 3.20
10.5	Ø 3.35
13.5	Ø 3.60
21	Ø 4.40

# 4	Diam.
0	Ø 3.10
7.5	Ø 3.70
10.5	Ø 3.90
15.5	Ø 4.30

# 5	Diam.
0	Ø 3.90
10	Ø 5.00
13	Ø 5.20
20.5	Ø 6.30

# 6	Diam.
0	Ø 5.50
10	Ø 6.20
13	Ø 6.30



15.5 cm

# 1  
Ø 1.6 mm



QI-06-146  
15.5 cm

# 2  
Ø 1.9 mm



QI-06-147  
15.5 cm

# 3  
Ø 2.8 mm



QI-06-148  
15.5 cm

# 4  
Ø 3.10 mm



QI-06-149  
15.5 cm

# 5  
Ø 3.90 mm



QI-06-150  
15.5 cm

# 6  
Ø 5.50 mm



QI-06-151  
15.5 cm

# 1	Diam.
0	Ø 1.50
5	Ø 1.90
8	Ø 2.20
10	Ø 2.40
12	Ø 2.60
14	Ø 2.80

# 2	Diam.
0	Ø 2.10
5	Ø 2.60
8	Ø 2.80
10	Ø 3.00
12	Ø 3.20
14	Ø 3.40

# 3	Diam.
0	Ø 2.60
5	Ø 3.00
8	Ø 3.30
10	Ø 3.50
12	Ø 3.70
14	Ø 3.90

# 4	Diam.
0	Ø 3.00
5	Ø 3.50
8	Ø 3.80
10	Ø 4.00
12	Ø 4.20
14	Ø 4.40

# 5	Diam.
0	Ø 3.50
5	Ø 3.90
8	Ø 4.20
10	Ø 4.40
12	Ø 4.60
14	Ø 4.80

Spelling Straight  
Bone Pusher

# 1  
Ø 1.5 mm



QI-06-152  
15.5 cm

# 2  
Ø 2.1 mm



QI-06-153  
15.5 cm

# 3  
Ø 2.6 mm



QI-06-154  
15.5 cm

# 4  
Ø 3.0 mm



QI-06-155  
15.5 cm

# 5  
Ø 3.5 mm



QI-06-156  
15.5 cm

Ø 2.8 mm



QI-06-157  
15.5 cm

Ø 3.5 mm



QI-06-158  
15.5 cm

Ø 4.2 mm

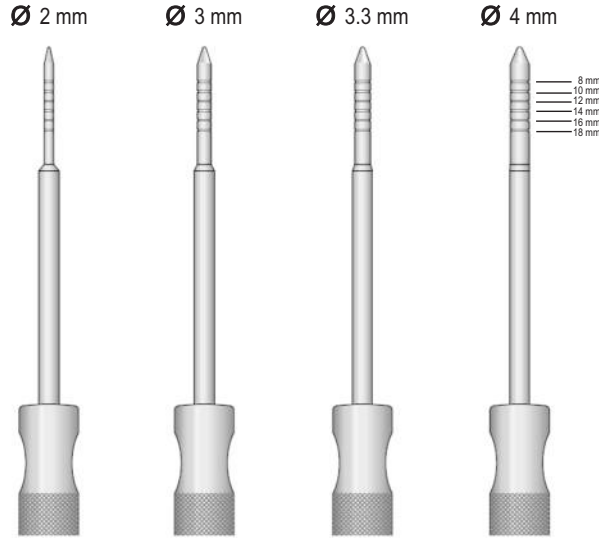


QI-06-159  
15.5 cm



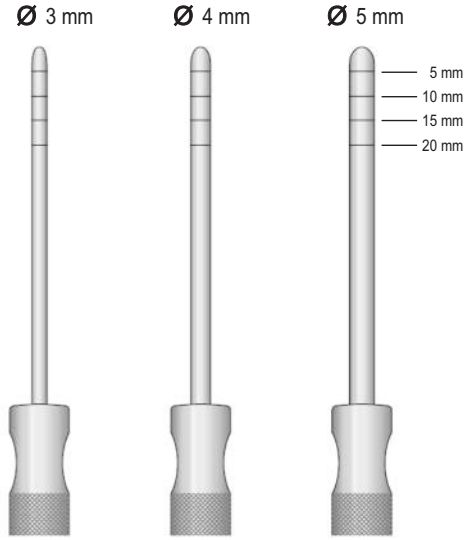
15 cm

Pointed



**QI-06-160** 15 cm  
**QI-06-161** 15 cm  
**QI-06-162** 15 cm  
**QI-06-163** 15 cm

Convex Tips

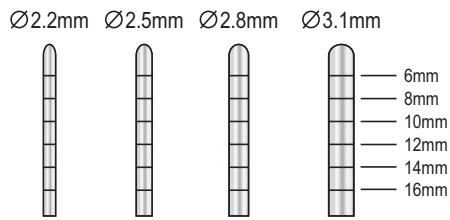


**QI-06-164** 15 cm  
**QI-06-165** 15 cm  
**QI-06-166** 15 cm

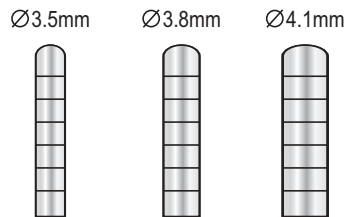
### Convex Tips



16.5 cm  
Str



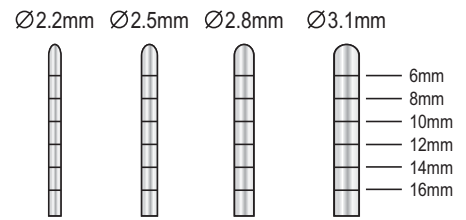
**QI-06-167** **QI-06-168** **QI-06-169** **QI-06-170**



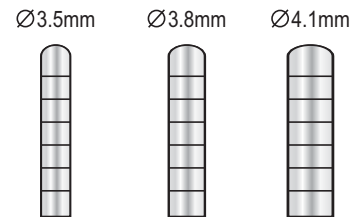
**QI-06-171** **QI-06-172** **QI-06-173**



16.5 cm  
Cvd



**QI-06-174** **QI-06-175** **QI-06-176** **QI-06-177**



**QI-06-178** **QI-06-179** **QI-06-180**



					<b>Osteotomes with Stop</b>									
					<b>Concave</b>					<b>Concave</b>				
					Ø2mm    Ø3mm    Ø3.3mm    Ø4mm 					Ø2mm    Ø3mm    Ø3.3mm    Ø4mm 				
					6mm 11mm 15mm QI-06-181    QI-06-182    QI-06-183    QI-06-184					6mm 11mm 15mm QI-06-193    QI-06-194    QI-06-195    QI-06-196				
					<b>Convex</b>					<b>Convex</b>				
					Ø2mm    Ø3mm    Ø3.3mm    Ø4mm 					Ø2mm    Ø3mm    Ø3.3mm    Ø4mm 				
					6mm 11mm 15mm QI-06-185    QI-06-186    QI-06-187    QI-06-188					6mm 11mm 15mm QI-06-197    QI-06-198    QI-06-199    QI-06-200				
					<b>Pointed</b>					<b>Pointed</b>				
					Ø2mm    Ø3mm    Ø3.3mm    Ø4mm 					Ø2mm    Ø3mm    Ø3.3mm    Ø4mm 				
					6mm 11mm 15mm QI-06-189    QI-06-190    QI-06-191    QI-06-192					6mm 11mm 15mm QI-06-201    QI-06-202    QI-06-203    QI-06-204				
16.5 cm Str										16.5 cm Cvd				
					<b>Concave</b>					<b>Concave</b>				
					Ø2.5mm    Ø3mm    Ø3.8mm    Ø4.5mm    Ø5mm 					Ø2.5mm    Ø3mm    Ø3.8mm    Ø4.5mm    Ø5mm 				
					8mm 11mm 13mm 15mm 17mm 20mm QI-06-205    QI-06-2065    QI-06-207    QI-06-208    QI-06-209					8mm 11mm 13mm 15mm 17mm 20mm QI-06-210    QI-06-211    QI-06-212    QI-06-213    QI-06-214				
					<b>Convex</b>					<b>Convex</b>				
					Ø2.5mm    Ø3mm    Ø3.8mm    Ø4.5mm    Ø5mm 					Ø2.5mm    Ø3mm    Ø3.8mm    Ø4.5mm    Ø5mm 				
					8mm 11mm 13mm 15mm 17mm 20mm 60-314-16    60-315-16    60-316-16    60-317-16    60-318-16					8mm 11mm 13mm 15mm 17mm 20mm QI-06-215    QI-06-216    QI-06-217    QI-06-218    QI-06-219				
					<b>Pointed</b>					<b>Pointed</b>				
					Ø2.5mm    Ø3mm    Ø3.8mm    Ø4.5mm    Ø5mm 					Ø2.5mm    Ø3mm    Ø3.8mm    Ø4.5mm    Ø5mm 				
					8mm 11mm 13mm 15mm 17mm 20mm 60-319-16    60-320-16    60-321-16    60-322-16    60-323-16					8mm 11mm 13mm 15mm 17mm 20mm QI-06-220    QI-06-221    QI-06-222    QI-06-223    QI-06-224				
16.5 cm Str										16.5 cm Cvd				

Trephine Drills



**QI-06-225**  
Interior 2 mm  
Exterior 3 mm

**QI-06-226**  
Interior 3 mm  
Exterior 4 mm

**QI-06-227**  
Interior 4 mm  
Exterior 5 mm

**QI-06-228**  
Interior 5 mm  
Exterior 6 mm

**QI-06-229**  
Interior 6 mm  
Exterior 7 mm

**QI-06-230**  
Interior 7 mm  
Exterior 8 mm

**QI-06-231**  
Interior 8 mm  
Exterior 9 mm

**QI-06-232**  
Interior 9 mm  
Exterior 10 mm



**QI-06-233**  
Trephine Drills Stand  
Complete with drills



**QI-06-234**  
Trephine Drills Stand  
Complete with drills

Tissue Punches



**QI-06-235**  
3 mm

**QI-06-236**  
4 mm

**QI-06-237**  
5 mm

**QI-06-238**  
8 mm

Keyes



**QI-06-239**  
3 mm

**QI-06-240**  
4 mm

**QI-06-241**  
5 mm

**QI-06-242**  
6 mm

Keyes

Bone Thickness Gauges



Fig. 1  
Castroviejo  
QI-06-243



Fig. 2  
Castroviejo  
QI-06-244



Fig. 3  
Castroviejo  
QI-06-245



Fig. 4  
Castroviejo  
QI-06-246

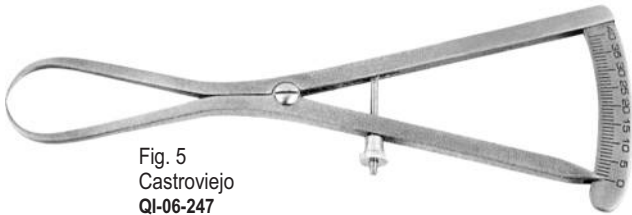


Fig. 5  
Castroviejo  
QI-06-247



QI-06-248  
Bone Thickness Gauge



QI-06-249  
Bone Caliper  
15 cm



60-371-00  
Sinus Rongeur  
Delicate bone cutting forcep  
for opening the sinus window  
4 mm bite, TiN coated

Bone Injectors



Fig. 1  
QI-06-250



Fig. 2  
QI-06-251



Fig. 3  
QI-06-252

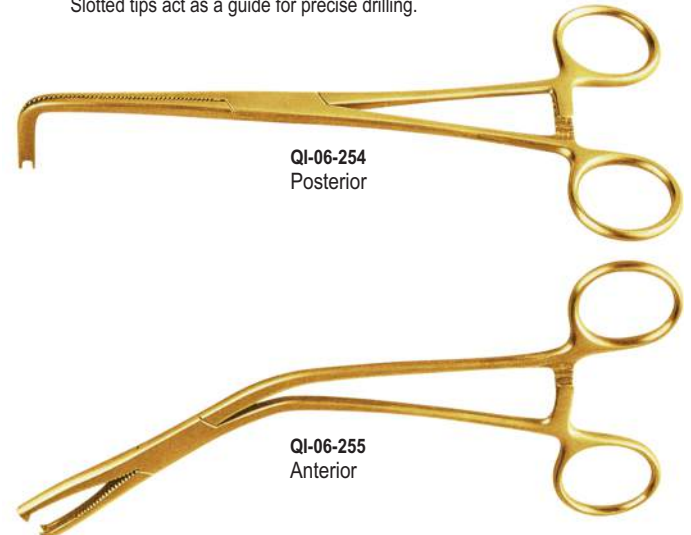


Fig. 4  
QI-06-253



TiN coated bone block clamps

To hold & stabilize block graft against recipient site while placing screws.  
Slotted tips act as a guide for precise drilling.



QI-06-254  
Posterior

QI-06-255  
Anterior

Depth measuring probes



QI-06-256  
Titanium tip, silicone handle & laser marked

Titanium implant periosteal elevators



Fig. 1 **QI-06-257** Busar Blue



Fig. 3 **QI-06-258** Prichard Blue

Implant periosteal elevators



Fig. 1 **QI-06-259** Busar



Fig. 9A **QI-06-260** Allen



Fig. 25 **QI-06-261** 17 cm

Gingivectomy Knives

Hollow handle

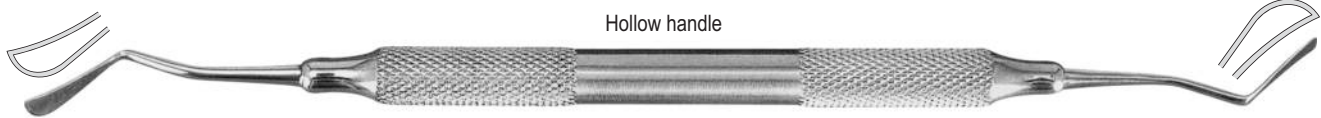


Fig. 15/16 **QI-06-262** Kirkland



Fig. 1/2 **QI-06-263** Orban

Solid handle



Fig. 15/16 **QI-06-264** Kirkland

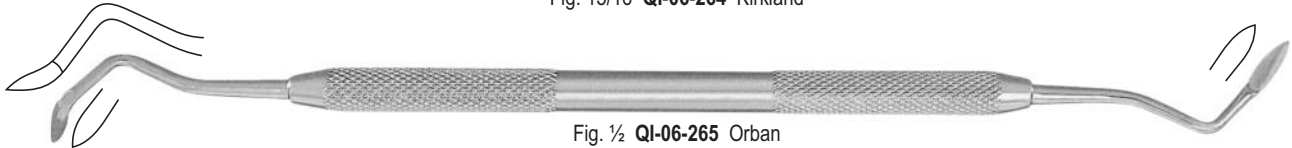


Fig. 1/2 **QI-06-265** Orban



Fig. 1 **QI-06-266** Orban



Fig. 2 **60-382-02** Orban

BONE CURETTES  
CURETTE PER OSSO

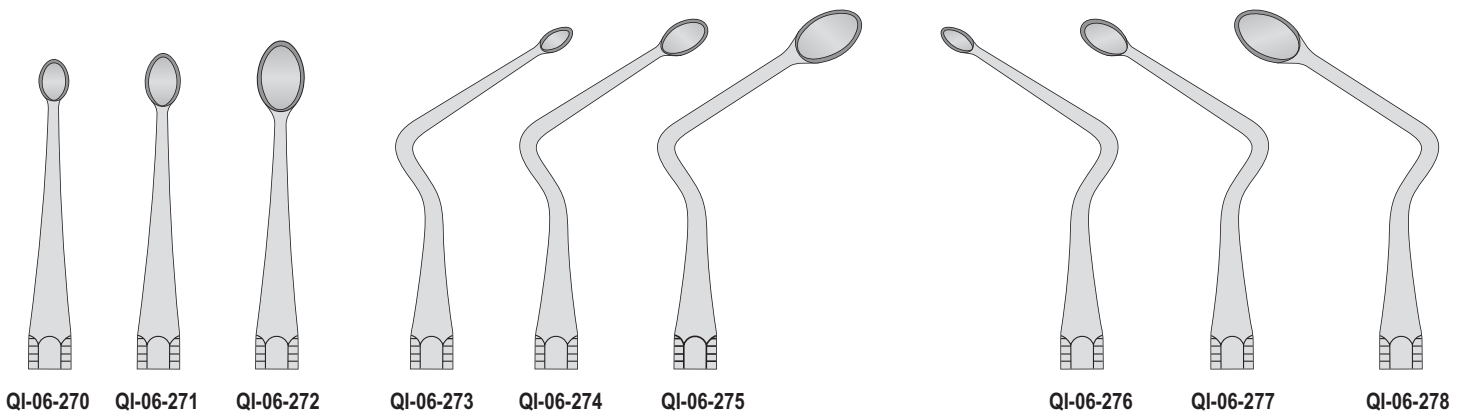
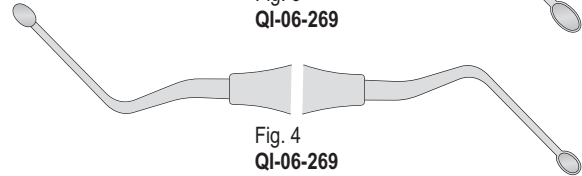
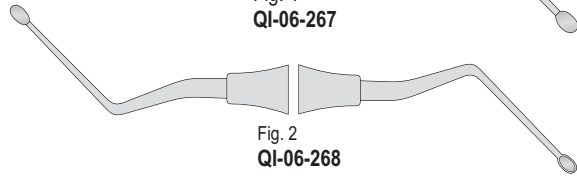
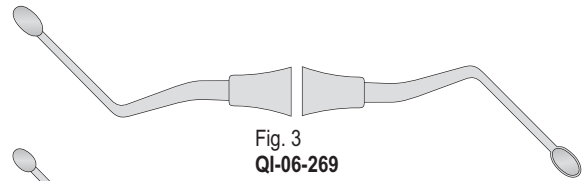
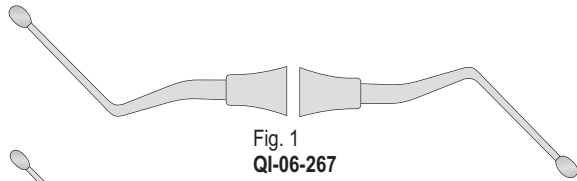
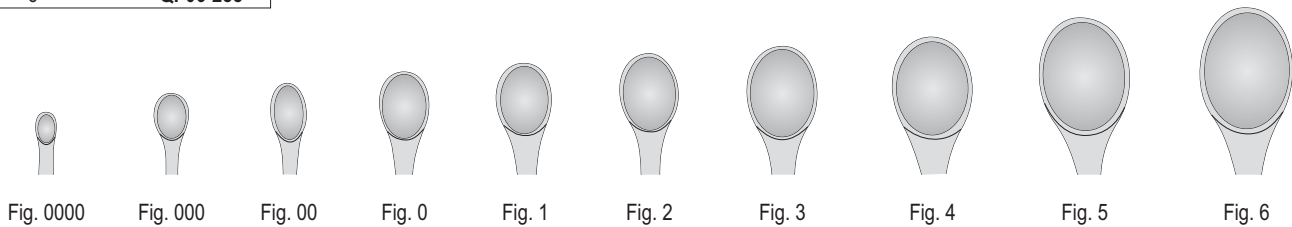
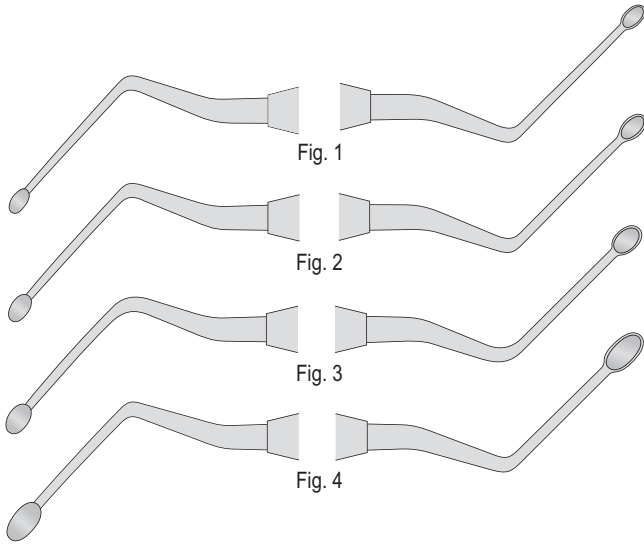
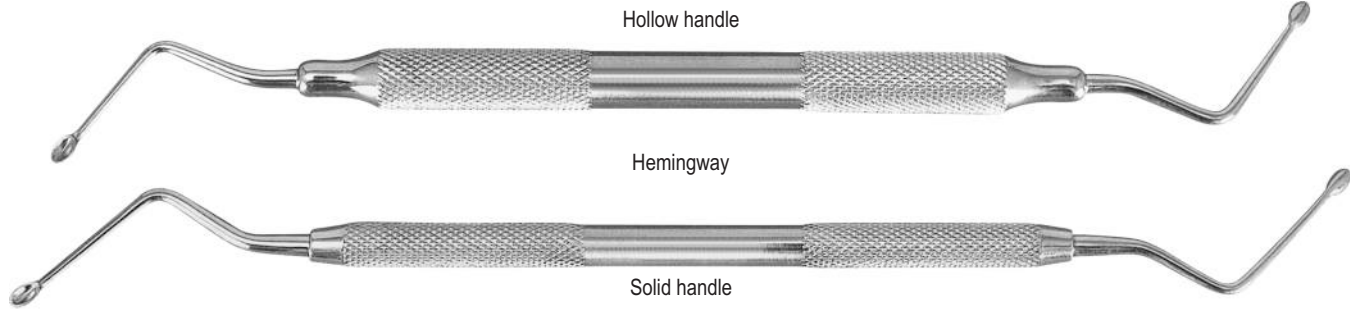
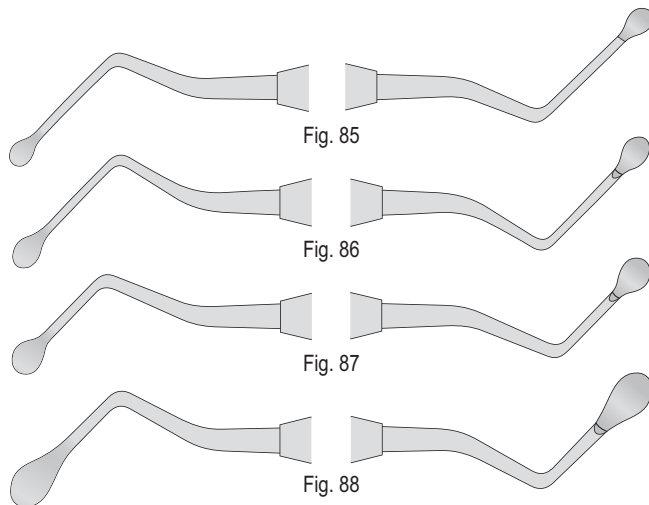
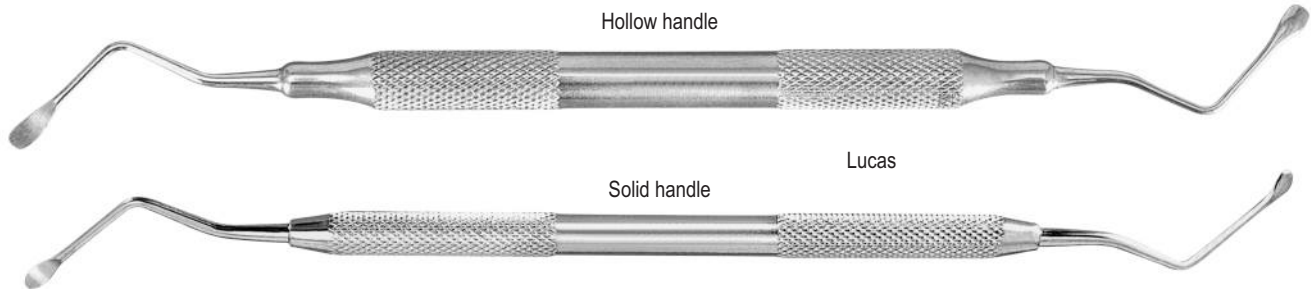


Fig.	Volkman
0000	QI-06-279
000	QI-06-280
00	QI-06-281
0	QI-06-282
1	QI-06-283
2	QI-06-284
3	QI-06-285
4	QI-06-286
5	QI-06-287
6	QI-06-288





	Solid handle	Hollow handle
Fig. 1	<b>QI-06-290</b>	<b>QI-06-294</b>
Fig. 2	<b>QI-06-291</b>	<b>QI-06-295</b>
Fig. 3	<b>QI-06-292</b>	<b>QI-06-296</b>
Fig. 4	<b>QI-06-293</b>	<b>QI-06-297</b>



	Solid handle	Hollow handle
Fig. 85	<b>QI-06-298</b>	<b>QI-06-302</b>
Fig. 86	<b>QI-06-299</b>	<b>QI-06-303</b>
Fig. 87	<b>QI-06-300</b>	<b>QI-06-304</b>
Fig. 88	<b>QI-06-301</b>	<b>QI-06-305</b>

Bone curettes



Molt  
16.5 cm



Fig. 1  
QI-06-306

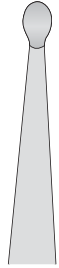


Fig. 2  
QI-06-307



Fig. 4  
QI-06-308

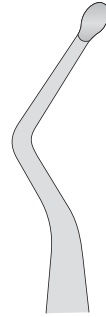


Fig. 5  
QI-06-309



Fig. 6  
QI-06-310

Bone Files



Williger  
14 cm



Fig. 00/0  
QI-06-311



Fig. 0/1  
QI-06-312



Fig. 1/2  
QI-06-313



Bone Files



Fig. 10  
QI-06-314



Fig. 12A  
QI-06-315



Fig. 33  
QI-06-316



Fig. 12  
QI-06-317  
Howard

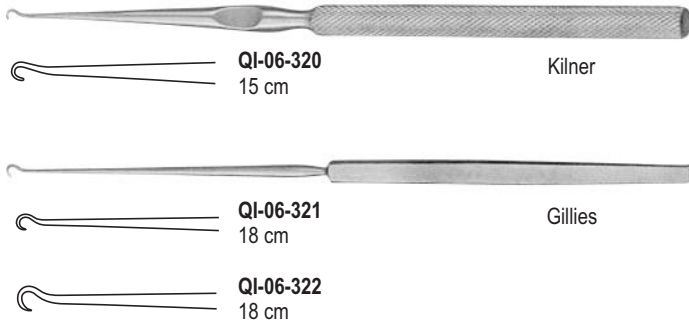


Fig. 45  
QI-06-318  
Miller

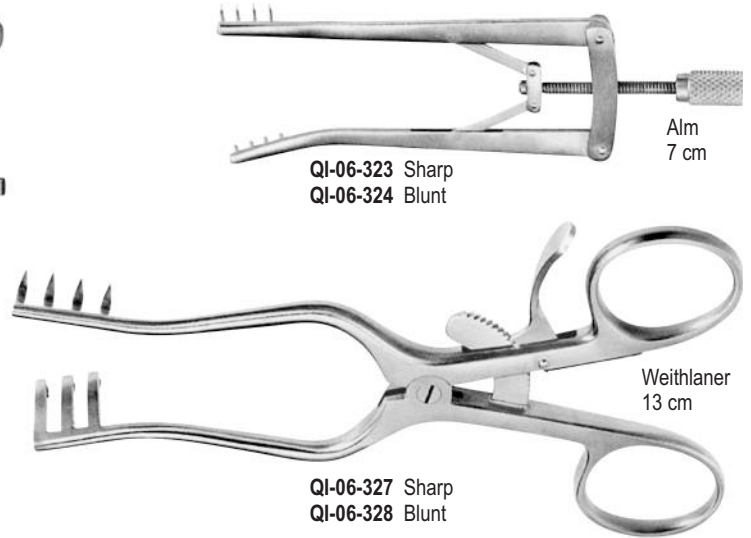


Fig. 64  
QI-06-319  
Miller

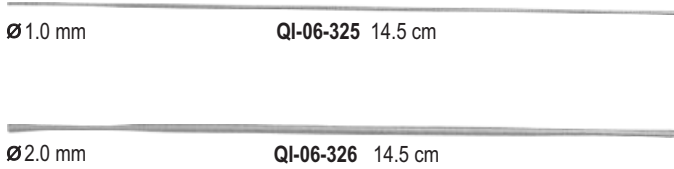
**Skin Hooks**



**Self-Retaining Retractors**



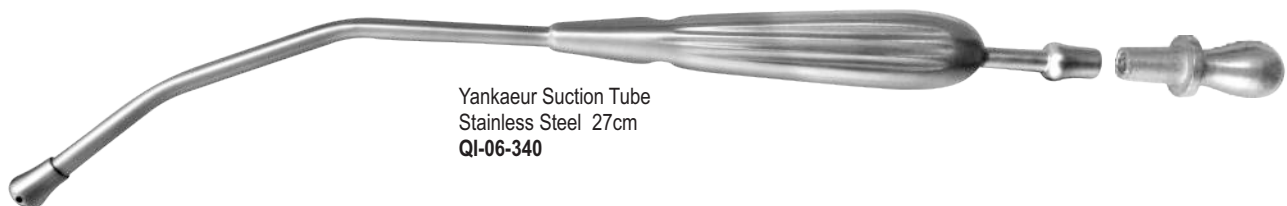
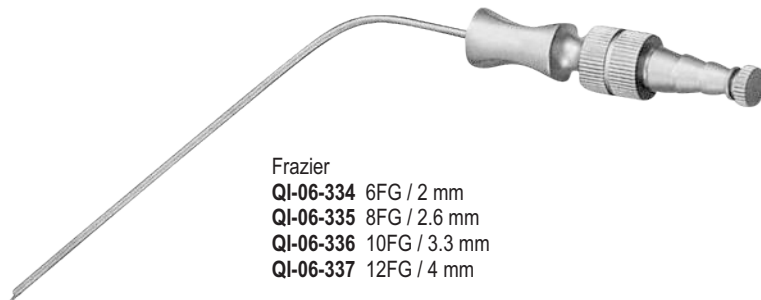
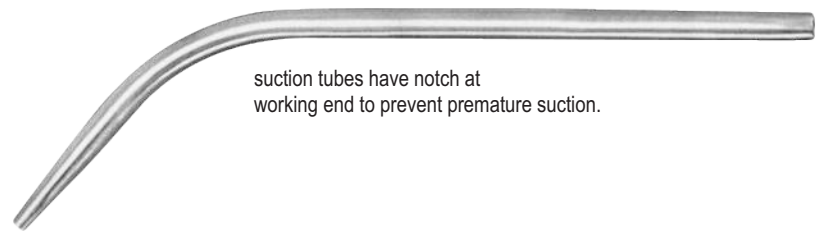
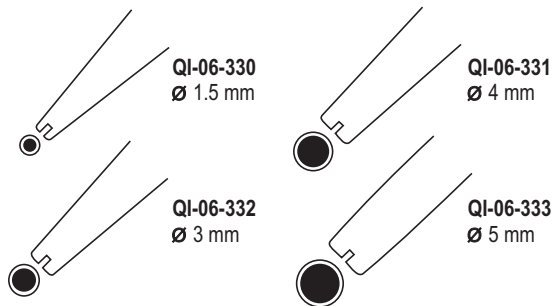
**Probes**



**Suture Forceps**



**Suction Tubes**





## Mirror Handles, Scalers & Knives

Mouth Mirror & Mirror Handles  
Scaler Handles  
Scalpel Blades & Handles  
Micro Scalpel Handles & Blades  
Explorers Double Ended  
Explorers Single Ended  
Probes Single Ended  
Gracey Curettes  
Periodontal Instruments  
Scalers  
Endodontic Instruments  
Filling Instruments  
Cavity Preparation Tips & Amalgam Instruments  
Amalgam Pluggers  
Burnishers  
Composite / Plastic Filling Instruments  
Excavators  
Carvers & Finishing Knives  
Finishing Knives & Cleoid-Discoid  
Wax Modelling Carvers  
Cement Spatulae & Glass Mixing Slabs  
Plaster Knives - Alginate & Plaster Spatulae  
Wax Knives



Fig. 4  
QI-07-001  
Ø 22 mm

Fig. 5  
QI-07-002  
Ø 24 mm

Fig. 000  
QI-07-003  
Ø 10 mm

Fig. 00  
QI-07-004  
Ø 12 mm

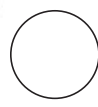
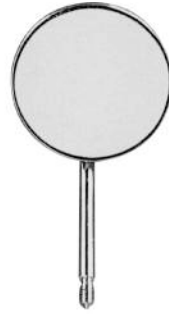


Fig. 2  
18 mm

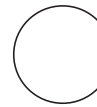


Fig. 3  
20 mm

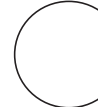


Fig. 4  
22 mm



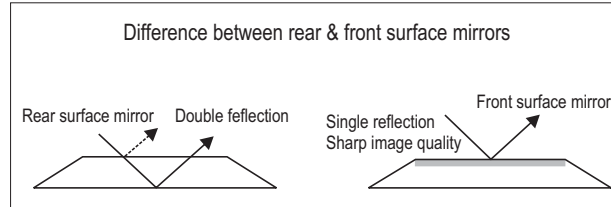
Fig. 5  
24 mm



- Rhodium coated front surface mirror
- Wide stem offers comfortable cheek retraction
- Non glare satin finish

Micro mirrors  
Rhodium front surface

Fig.	Ø mm	Pack of 12			
		Front surface		Rear surface	
		Rhodium	Chrome	Magnifying	Plane
2	18	QI-07-005	-	QI-07-011	QI-07-015
3	20	QI-07-006	-	QI-07-012	QI-07-016
4	22	QI-07-007	QI-07-009	QI-07-013	QI-07-017
5	24	QI-07-008	QI-07-010	QI-07-014	QI-07-018



### Mirror handles solid

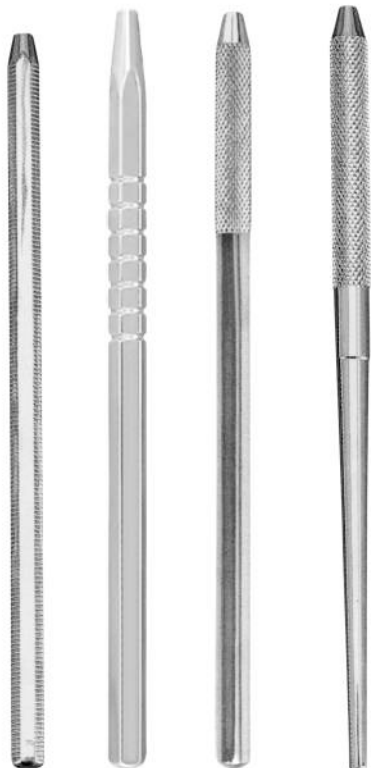


Fig. 1  
QI-07-019

Fig. 2  
QI-07-020

Fig. 3  
QI-07-021

Fig. 4  
QI-07-022

### Mirror handles hollow

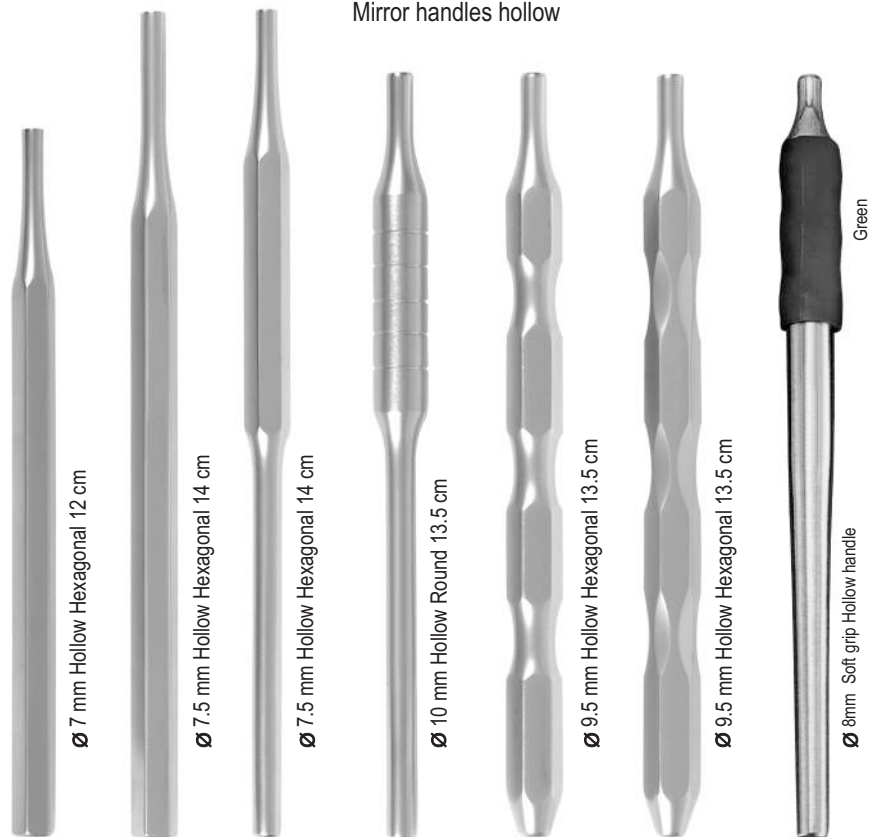


Fig. 1  
QI-07-023

Fig. 2  
QI-07-024

Fig. 3  
QI-07-025

Fig. 4  
QI-07-026

Fig. 5  
QI-07-027

Fig. 6  
QI-07-028

Fig. 7  
QI-07-029

Ø 7 mm Hollow Hexagonal 12 cm

Ø 7.5 mm Hollow Hexagonal 14 cm

Ø 7.5 mm Hollow Hexagonal 14 cm

Ø 10 mm Hollow Round 13.5 cm

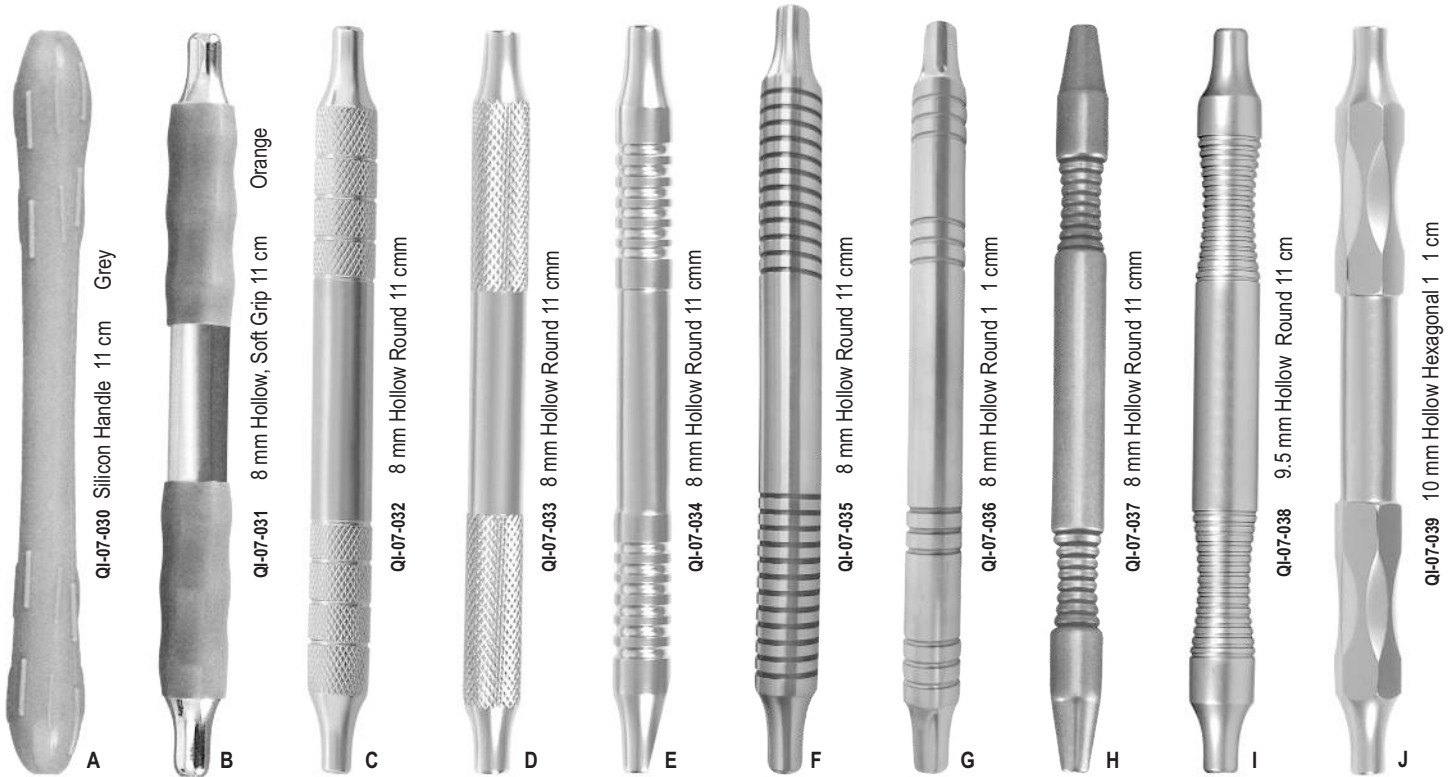
Ø 9.5 mm Hollow Hexagonal 13.5 cm

Ø 9.5 mm Hollow Hexagonal 13.5 cm

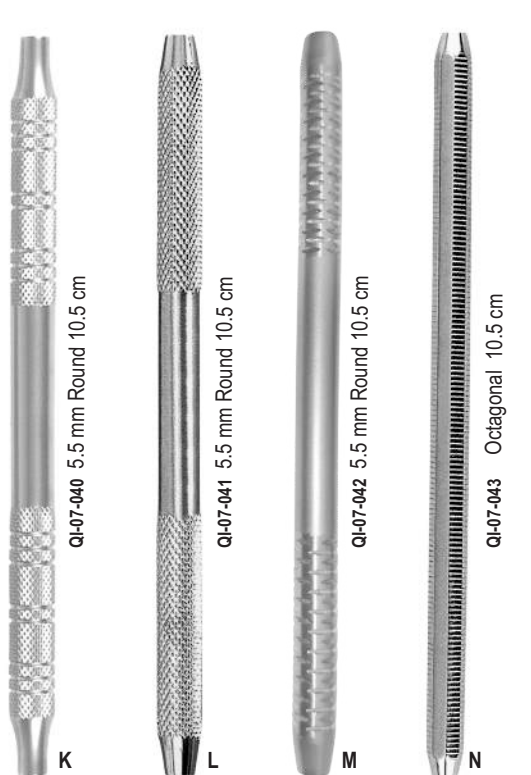
Ø 8mm Soft grip Hollow handle

Green

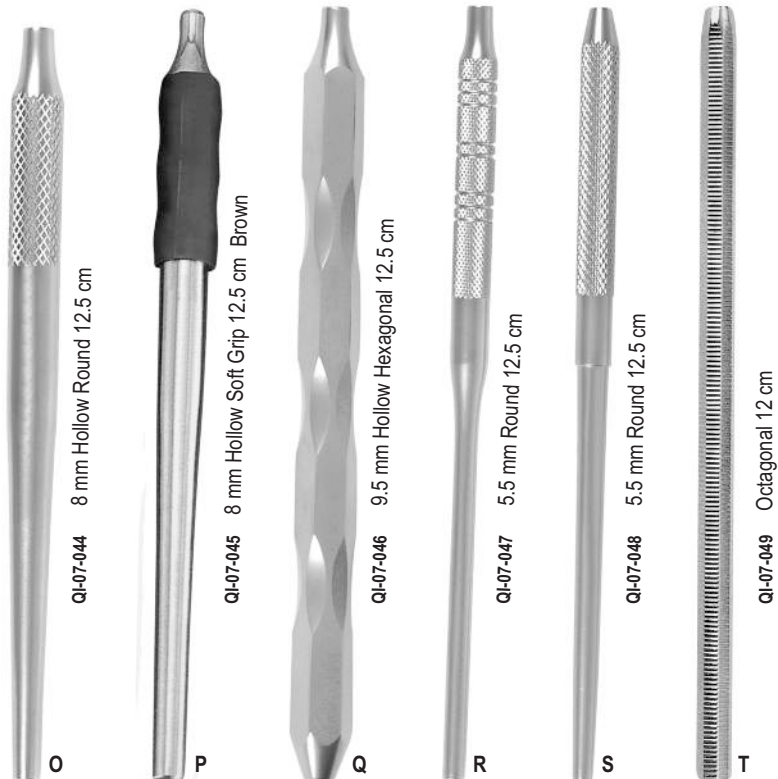
Double Ended



Double Ended



Single Ended



- Sterile
- Individually Packed
- Box of 100 Pieces



Fig. 10 QI-07-050    Fig. 11 QI-07-051    Fig. 12 QI-07-052    Fig. 12D QI-07-053    Fig. 13 QI-07-054    Fig. 15 QI-07-055    Fig. 15C QI-07-056    Fig. 20 QI-07-057    Fig. 21 QI-07-058    Fig. 22 QI-07-059    Fig. 23 QI-07-060    Fig. 24 QI-07-061    Fig. 25 QI-07-062



For scalpel No. 10, 11, 12, 12D, 13, 15, 15C

For Blades No. 20, 21, 22, 23, 24, 25

Fig. 3 QI-07-063    Fig. 3G QI-07-064    Fig. 4 QI-07-065    Fig. 3L QI-07-066    Fig. 7K QI-07-067    Fig. 7 QI-07-068    50-130-01 QI-07-069    Fig. 5S QI-07-070    Fig. 5A QI-07-071    Fig. 5 QI-07-072    Fig. 5 QI-07-073

Red

Micro scalpel & micro mirror handles

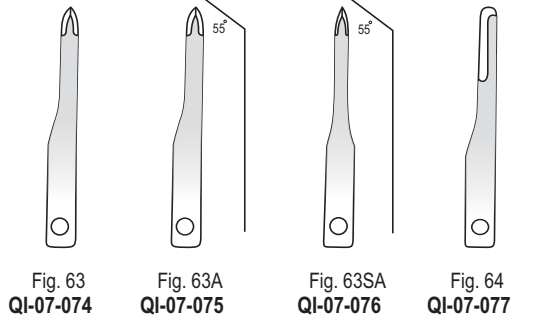


Fig. 63 **QI-07-074**    Fig. 63A **QI-07-075**    Fig. 63SA **QI-07-076**    Fig. 64 **QI-07-077**

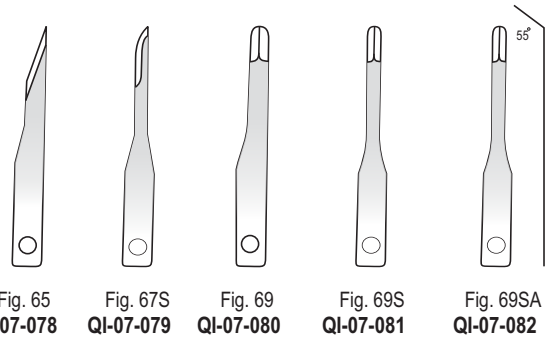
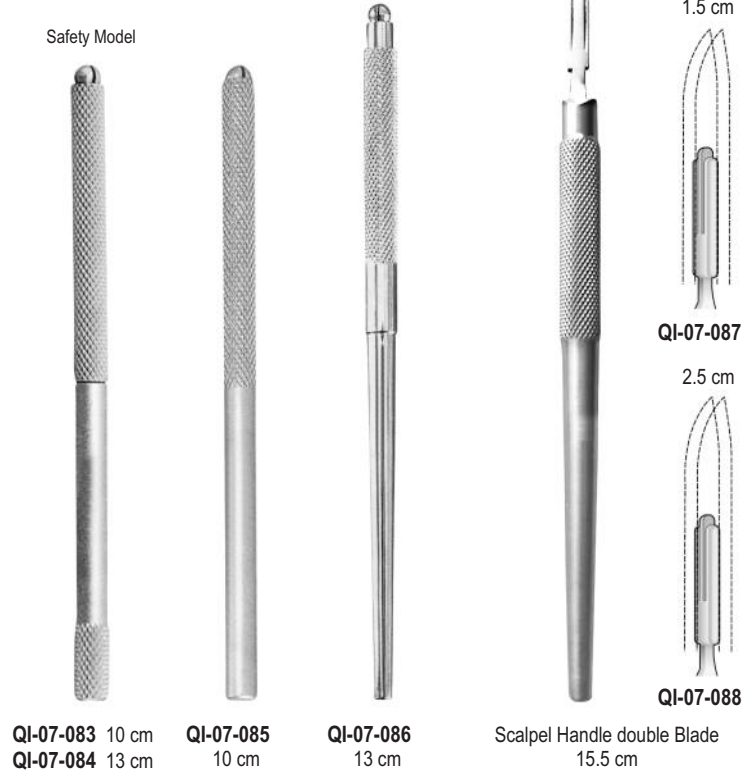


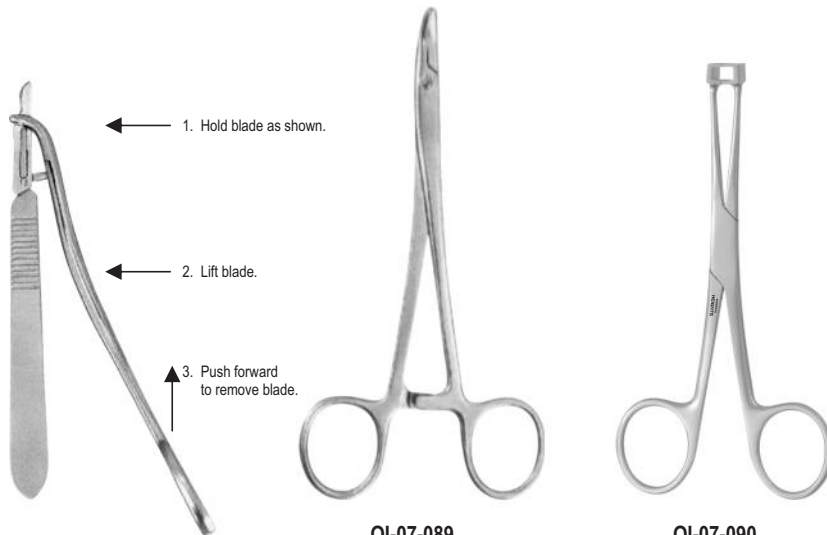
Fig. 65 **QI-07-078**    Fig. 67S **QI-07-079**    Fig. 69 **QI-07-080**    Fig. 69S **QI-07-081**    Fig. 69SA **QI-07-082**

Safety Model

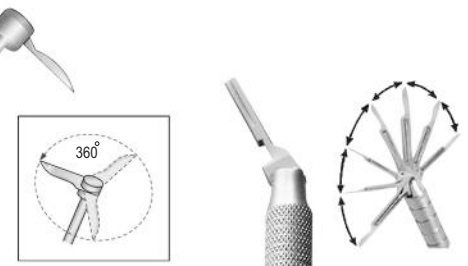


**QI-07-083** 10 cm    **QI-07-084** 13 cm    **QI-07-085** 10 cm    **QI-07-086** 13 cm    Scalpel Handle double Blade 15.5 cm

Scalpel Blade removing Forceps



**QI-07-089** 15 cm    **QI-07-090** 13.5 cm    **QI-07-091** 16.5 cm



Scalpel Handle Adjustable  
 Locks at Angles: 30°, 60°, 90°, 120°, 150°, 180°  
**QI-07-092**

Explorers double ended rigid



Fig. 23/17 QI-07-093



Fig. 23/17A QI-07-094

Explorers double ended rigid



Fig. 23/17 QI-07-094



Fig. 23/17A QI-07-095



Fig. 23/16 QI-07-096

Explorers double ended Flexible



Fig. 2 QI-07-097

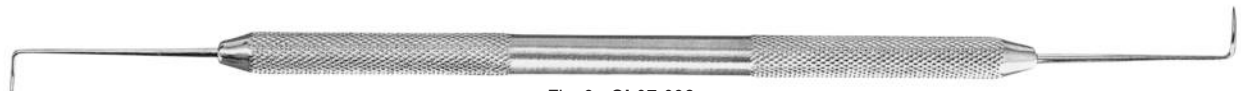


Fig. 3 QI-07-098



Fig. 5 QI-07-099



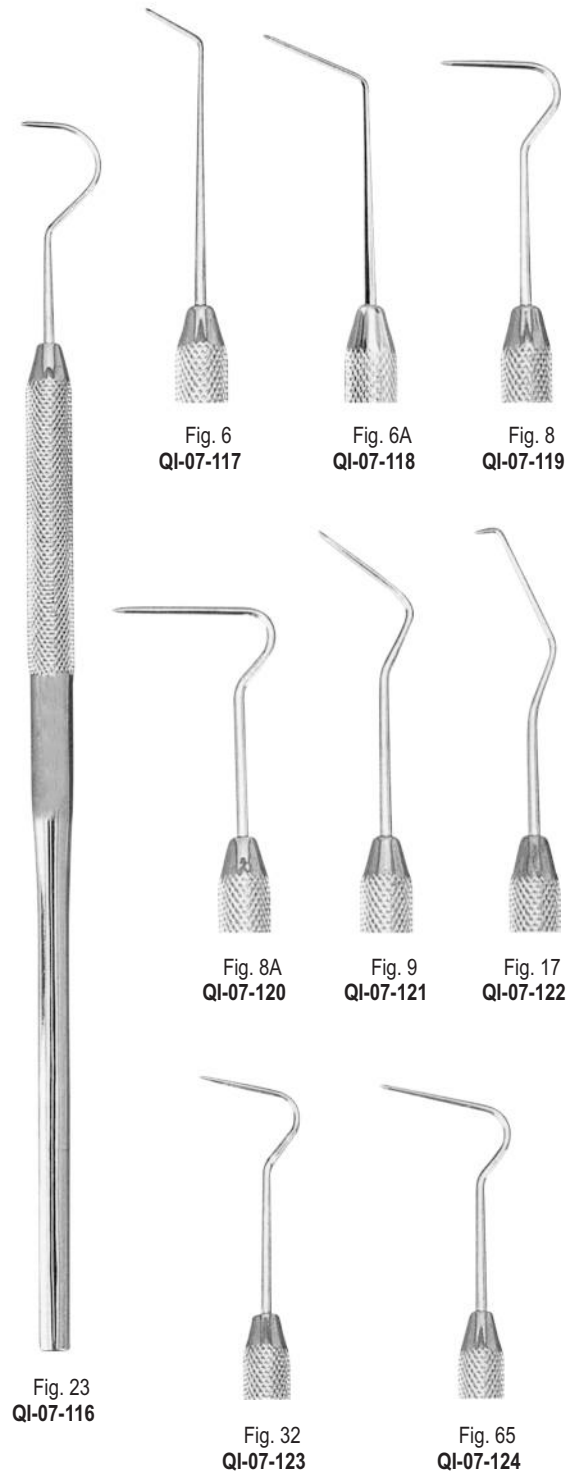
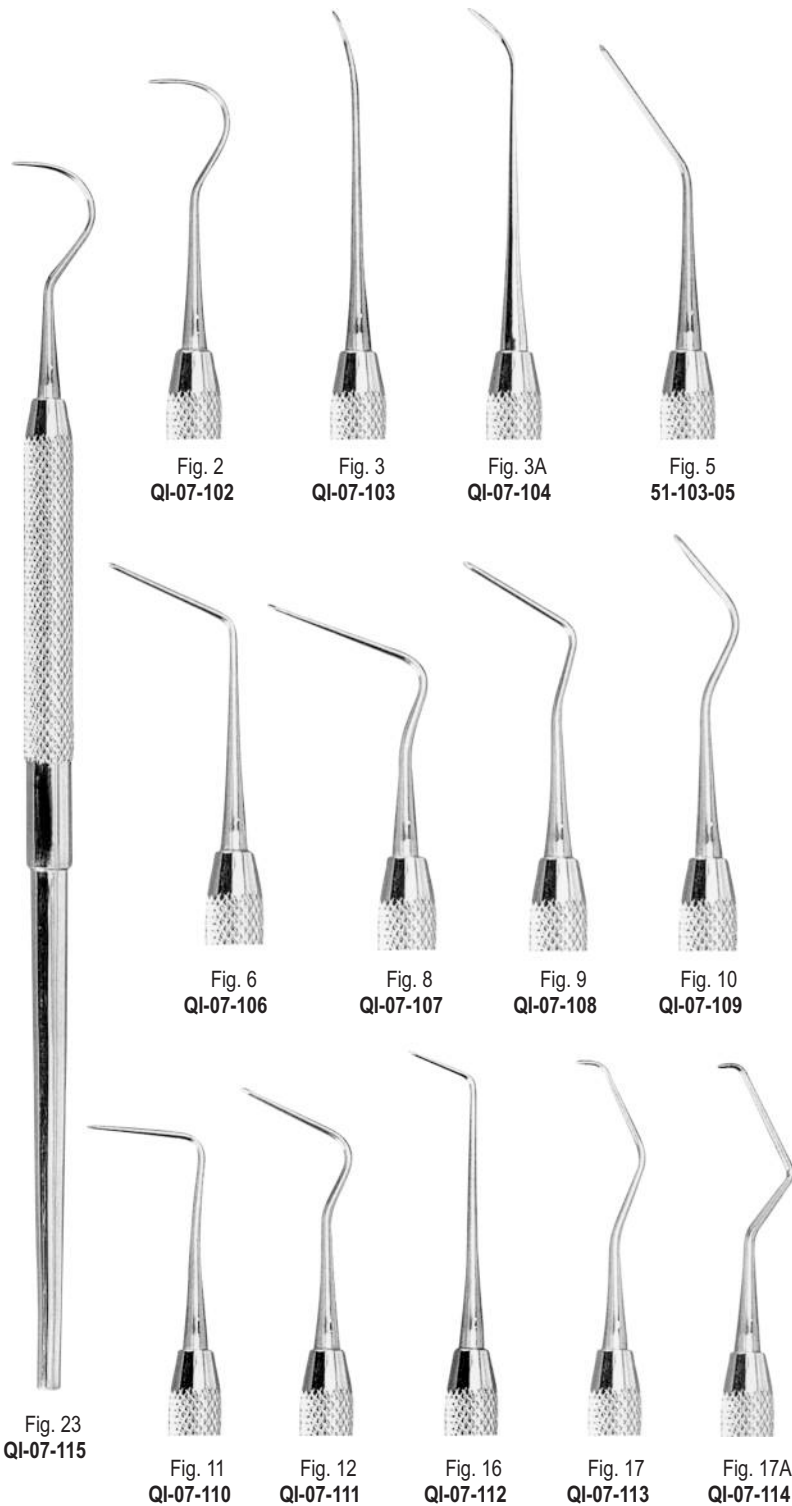
Fig. TU17/23 QI-07-100



Fig. 6/23 QI-07-101

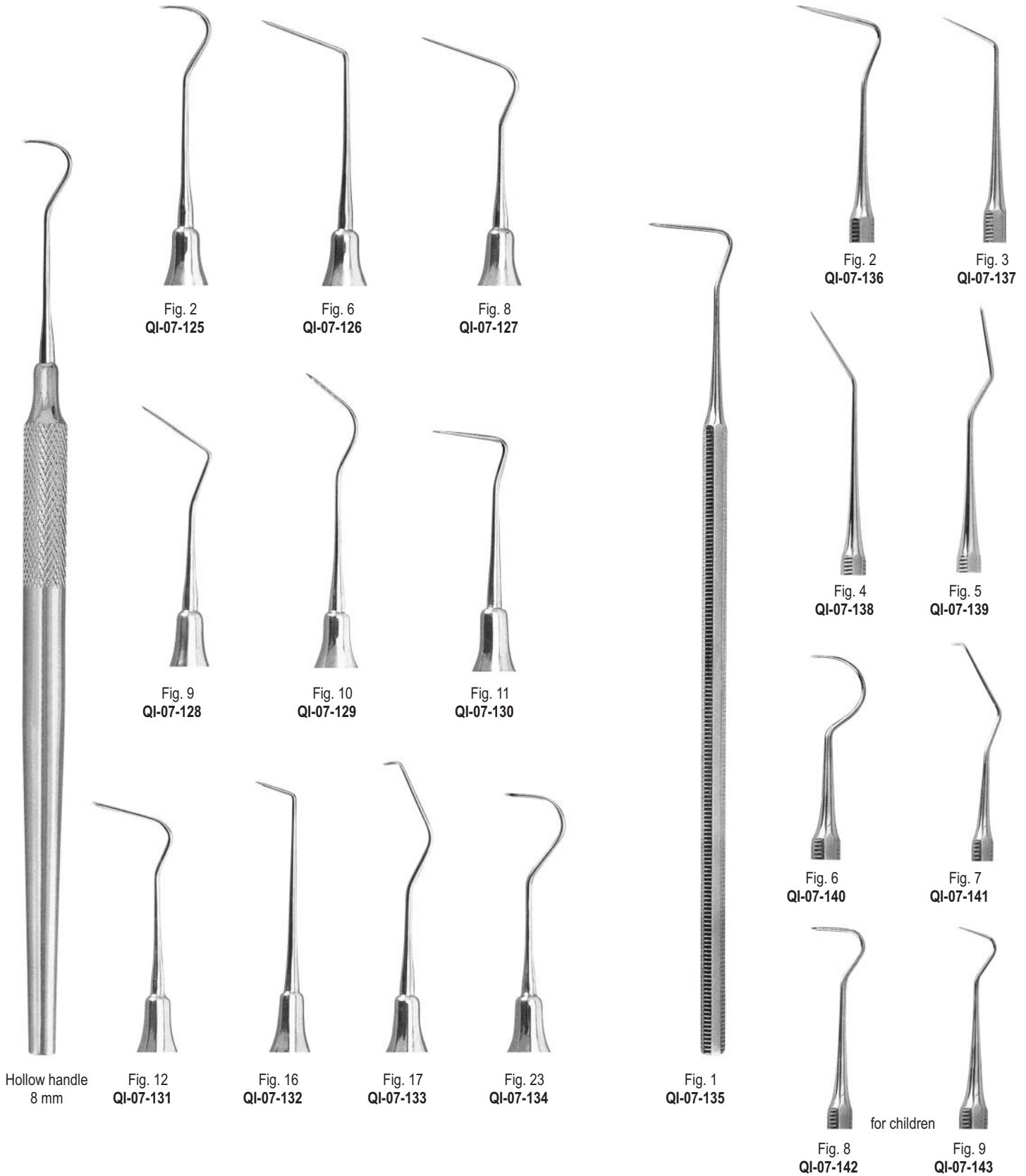
Explorers single ended rigid

Explorers single ended flexible



Explorers single ended rigid

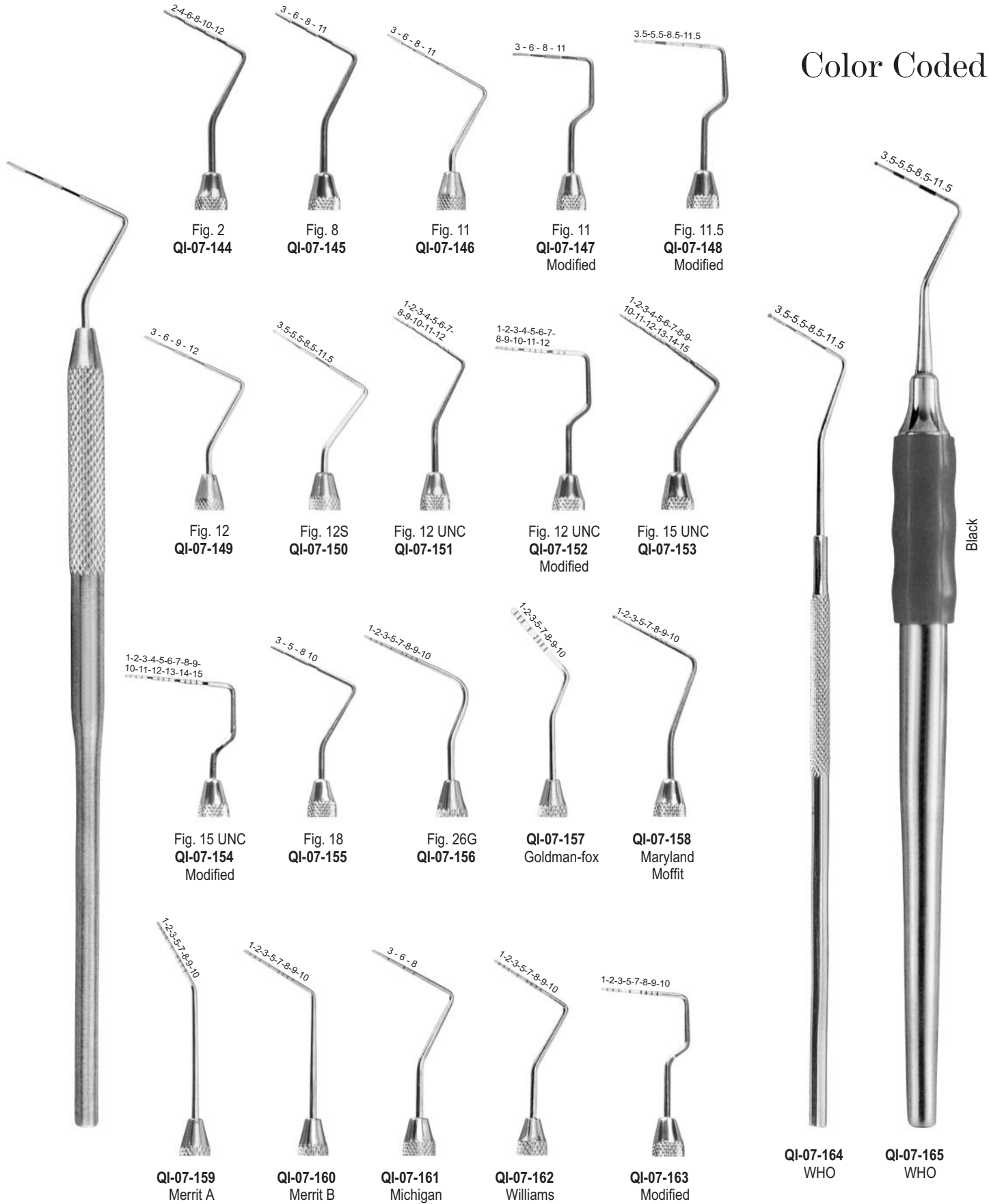
Explorers single ended rigid





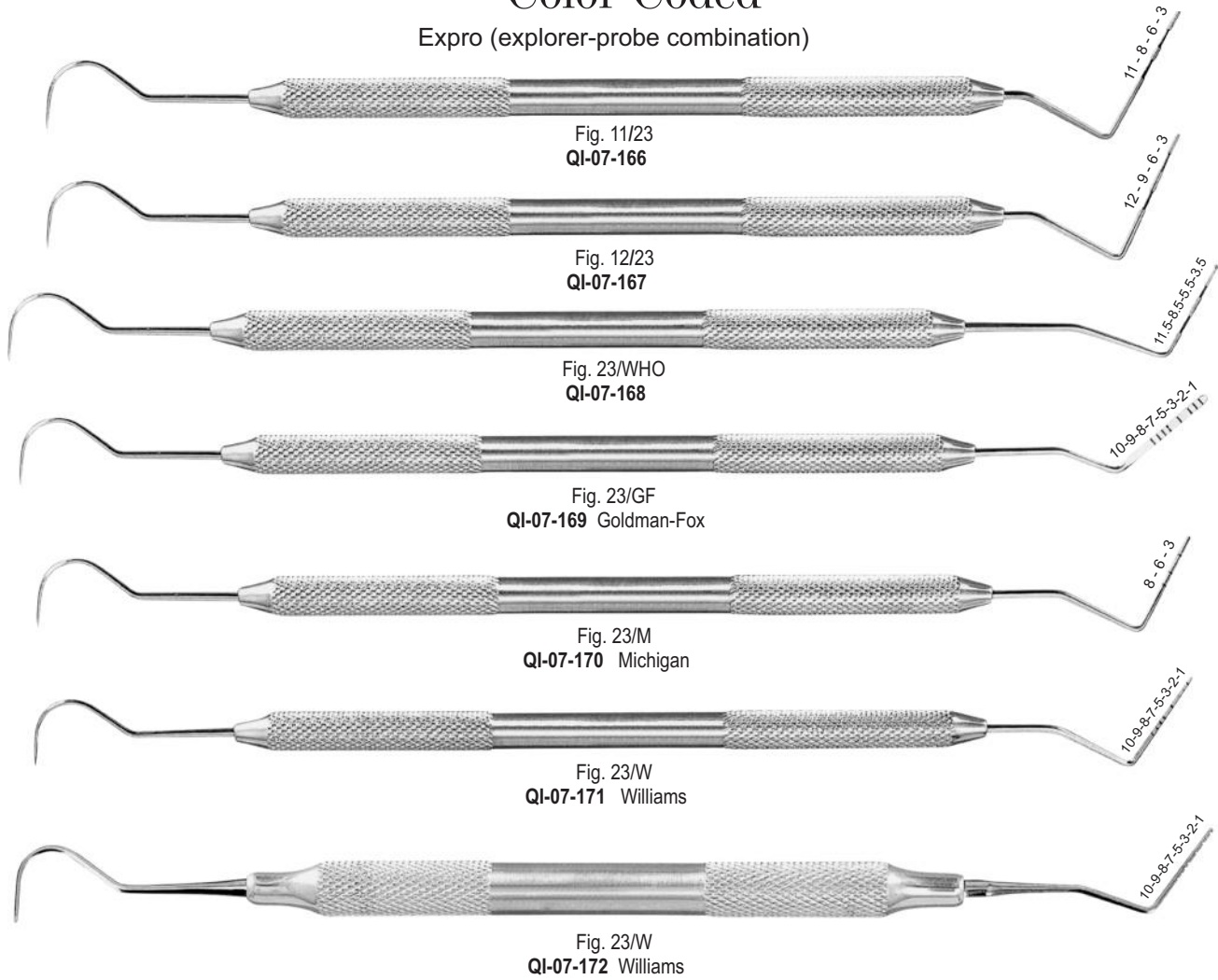
PROBES SINGLE ENDED  
SONDE A TERMINAZIONE SINGOLA

Color Coded

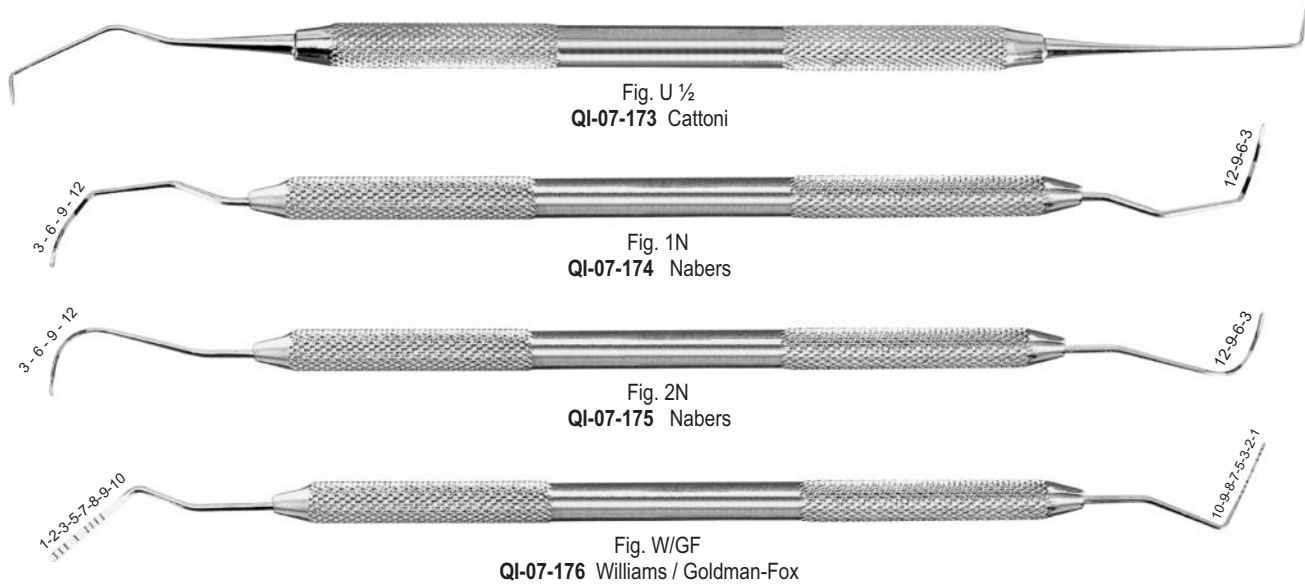


## Color Coded

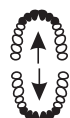
Expro (explorer-probe combination)



Probes double ended



- Ergonomic, large diameter silicone handle for better grip
- Ultra light weight
- Special grade stainless steel tips ensure longer life
- Rigid pattern, thicker tips than standard Gracey

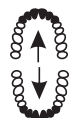


Anterior teeth



Grey

Fig. 1/2  
QI-07-177 Rigid  
QI-07-185 Standard

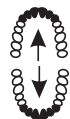


Anterior teeth



Black

Fig. 3/4  
QI-07-178 Rigid  
QI-07-186 Standard



Anterior and Premolars



Yellow

Fig. 5/6  
QI-07-179 Rigid  
QI-07-187 Standard



Premolars and Molars



Green

Fig. 7/8  
QI-07-180 Rigid  
QI-07-188 Standard



Molars buccal and lingual surfaces



Red

Fig. 9/10  
QI-07-181 Rigid  
QI-07-189 Standard



Posterior Mesial surfaces



Orange

Fig. 11/12  
QI-07-182 Rigid  
QI-07-190 Standard



Posterior distal surfaces



Blue

Fig. 13/14  
QI-07-183 Rigid  
QI-07-191 Standard

QI-07-177  
Set of 7 pieces / Rigid

QI-07-184  
Set of 7 pieces / Standard



Fig. 3/4  
**QI-07-193**  
Black  
Anterior teeth



Fig. 5/6  
**QI-07-194**  
Yellow  
Anterior and Premolars



Fig. 7/8  
**QI-07-195**  
Grey  
Premolars and Molars



Fig. 9/10  
**QI-07-196**  
Red  
Molars buccal and lingual surfaces



Fig. 11/12  
**QI-07-197**  
Orange  
Posterior mesial surfaces



Fig. 13/14  
**QI-07-198**  
Blue  
Posterior distal surfaces

**QI-07-199**  
Set of 7 pieces  
Fig. 1/2, 3/4, 5/6, 7/8, 9/10, 11/12, 13/14



Fig. 15/16  
**QI-07-200**  
Coffee  
Posterior mesial surfaces

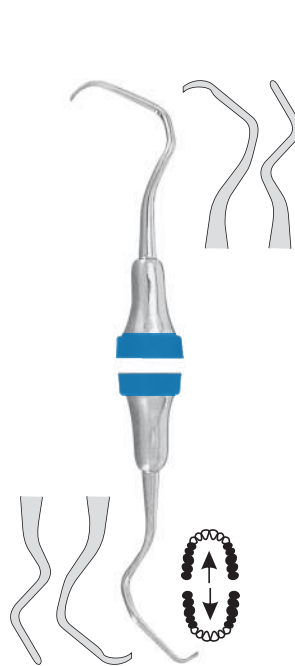


Fig. 17/18  
**QI-07-201**  
Light Blue  
Posterior distal surfaces



Fig. 11/14  
**QI-07-202**  
Blue  
Mesial/Distal surfaces



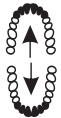
Fig. 12/13  
**QI-07-203**  
Orange  
Mesial/Distal surfaces

Fig. 1/2  
**QI-07-192**  
Green  
Anterior teeth

Solid handle



Hollow handle



Anterior teeth

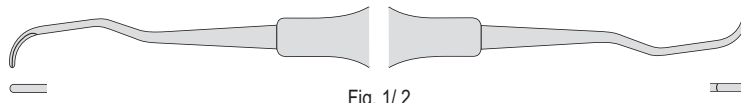


Fig. 1/2



Anterior teeth



Fig. 3/4



Anterior and  
Premolars

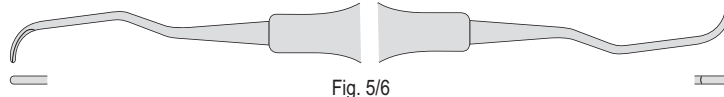


Fig. 5/6



Premolars and  
Molars



Fig. 7/8



Molars buccal and  
lingual surfaces



Fig. 9/10



Posterior mesial  
surfaces

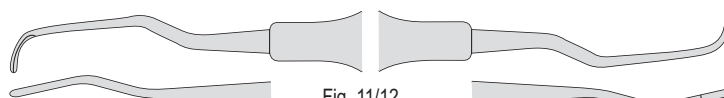


Fig. 11/12



Posterior distal  
surfaces

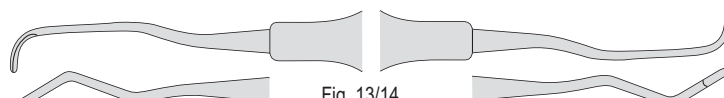


Fig. 13/14

	Solid handle
Fig. 1/2	<b>QI-07-204</b>
Fig. 3/4	<b>QI-07-205</b>
Fig. 5/6	<b>QI-07-206</b>
Fig. 7/8	<b>QI-07-207</b>
Fig. 9/10	<b>QI-07-208</b>
Fig. 11/12	<b>QI-07-209</b>
Fig. 13/14	<b>QI-07-210</b>

**QI-07-211**  
Gracey set of 7 pieces

	Hollow handle
Fig. 1/2	<b>QI-07-212</b>
Fig. 3/4	<b>QI-07-213</b>
Fig. 5/6	<b>QI-07-214</b>
Fig. 7/8	<b>QI-07-215</b>
Fig. 9/10	<b>QI-07-216</b>
Fig. 11/12	<b>QI-07-217</b>
Fig. 13/14	<b>QI-07-218</b>

**QI-07-219**  
Gracey set of 7 pieces

Periodontal chisels



Fig. 1 **QI-07-220** TG



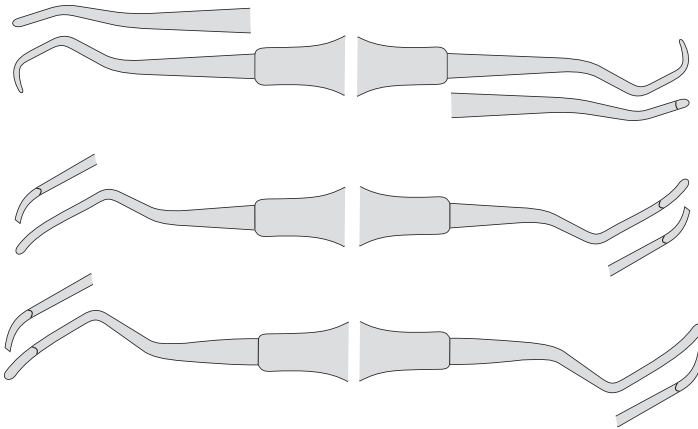
Fig. 2 **QI-07-221** TG

Universal Curettes Columbia

Solid handle



Hollow handle



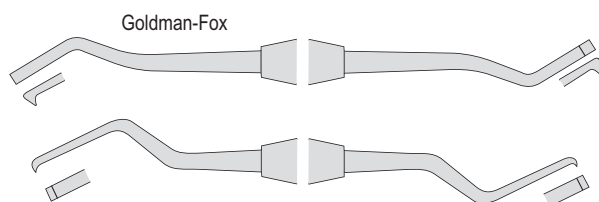
			Solid handle	Hollow handle
Universal	Fig. 13/14	<b>QI-07-222</b>	<b>QI-07-223</b>	
Anterior teeth	Fig. 2R/2L	<b>QI-07-224</b>	<b>QI-07-225</b>	
Posterior teeth	Fig. 4R/4L	<b>QI-07-226</b>	<b>QI-07-227</b>	

Hoe scalars

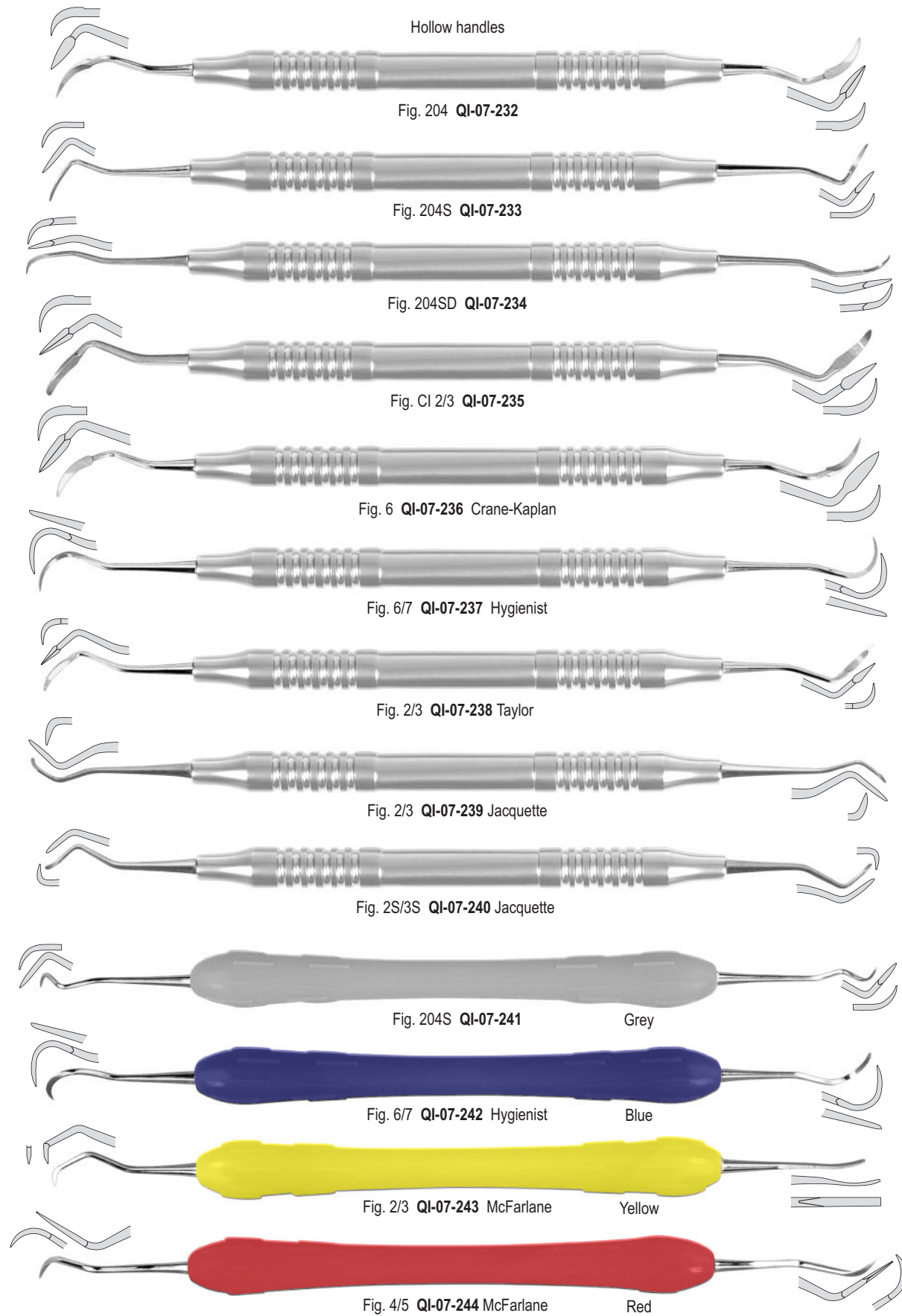
Solid handle



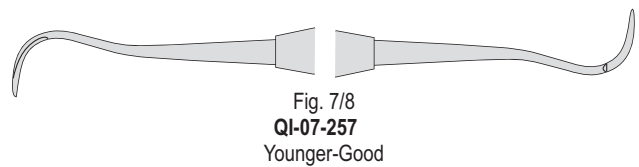
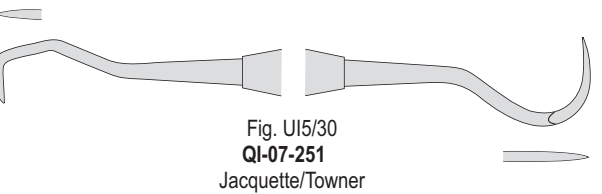
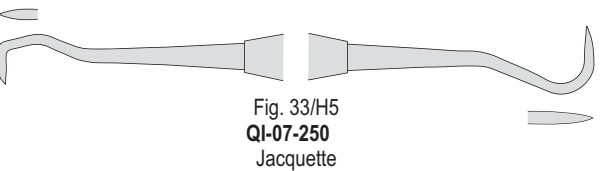
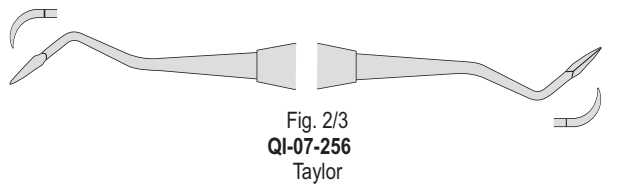
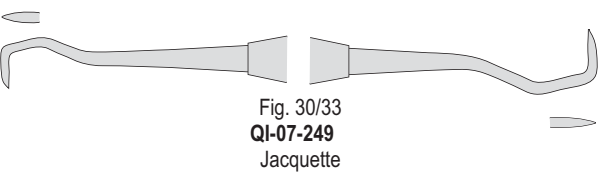
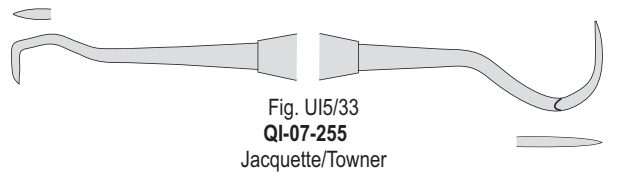
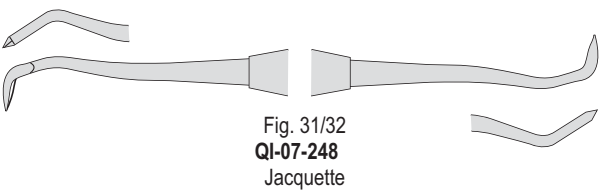
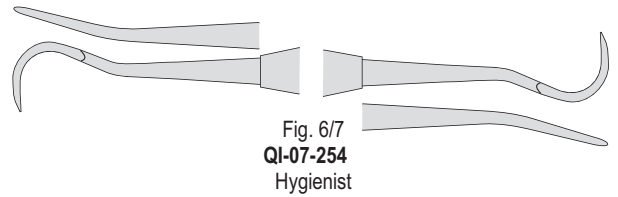
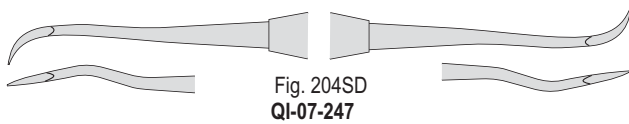
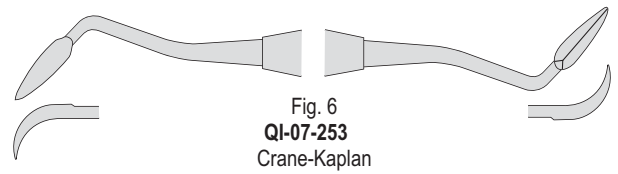
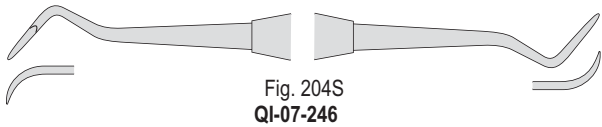
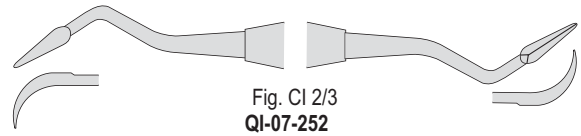
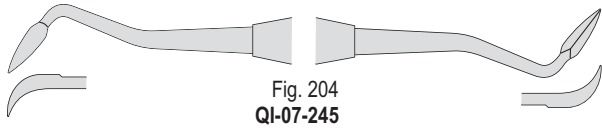
Hollow handle



		Solid handle	Hollow handle
Goldman-Fox	Fig. 5	<b>QI-07-227</b>	<b>QI-07-229</b>
	Fig. 6	<b>QI-07-230</b>	<b>QI-07-231</b>



Solid handle





Hollow handle

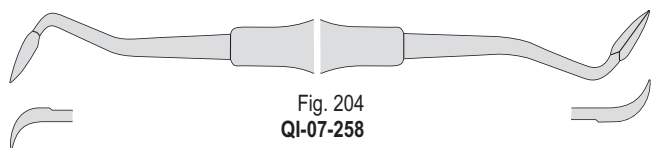
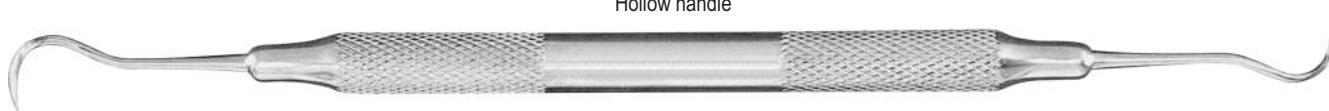


Fig. 204  
QI-07-258

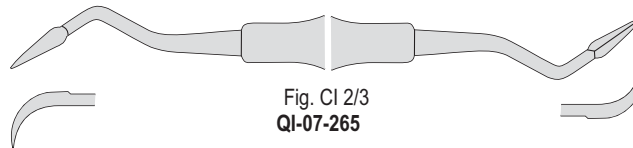


Fig. CI 2/3  
QI-07-265

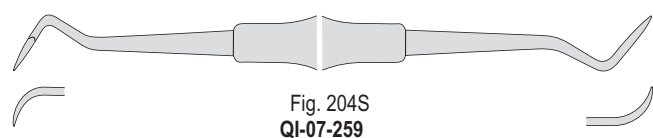


Fig. 204S  
QI-07-259

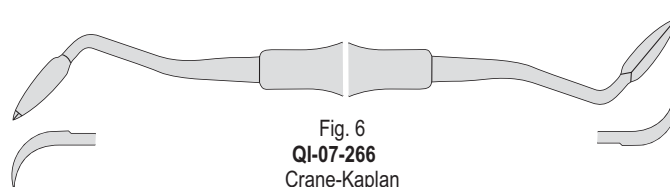


Fig. 6  
QI-07-266  
Crane-Kaplan

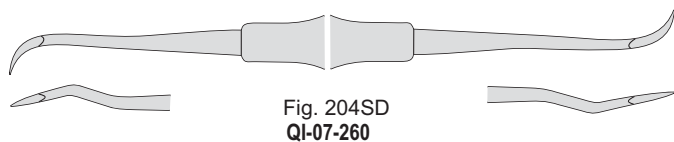


Fig. 204SD  
QI-07-260

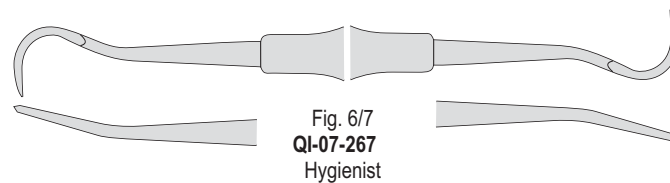


Fig. 6/7  
QI-07-267  
Hygienist

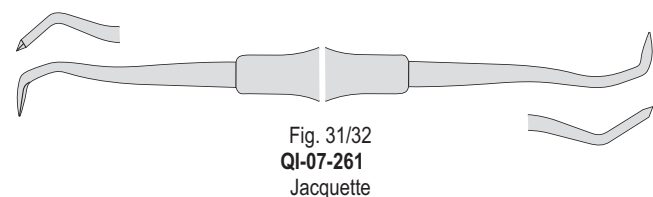


Fig. 31/32  
QI-07-261  
Jacquette

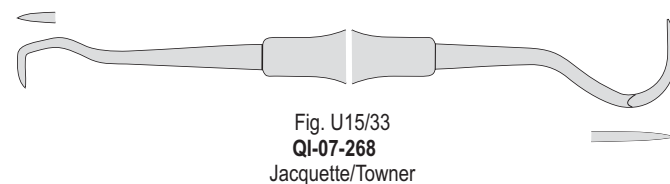


Fig. U15/33  
QI-07-268  
Jacquette/Towner

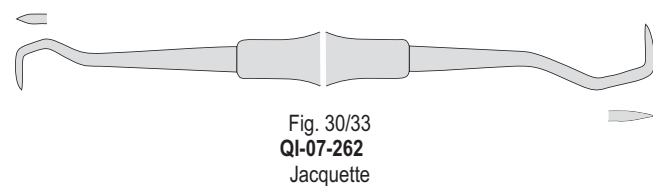


Fig. 30/33  
QI-07-262  
Jacquette

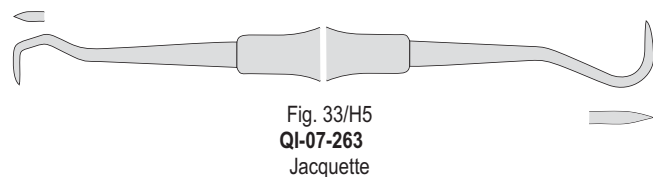


Fig. 33/H5  
QI-07-263  
Jacquette

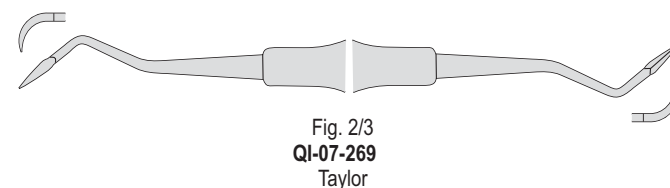


Fig. 2/3  
QI-07-269  
Taylor

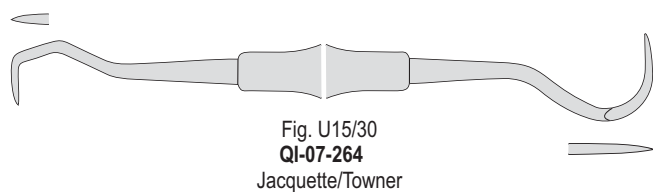


Fig. U15/30  
QI-07-264  
Jacquette/Towner

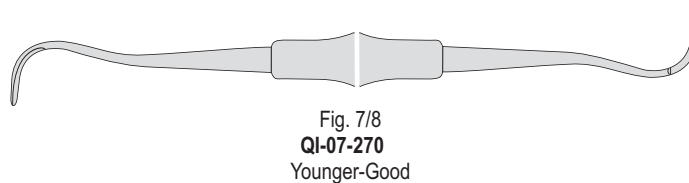
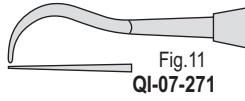


Fig. 7/8  
QI-07-270  
Younger-Good

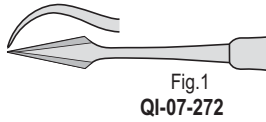
Solid Handle



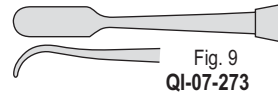
Darby Perry



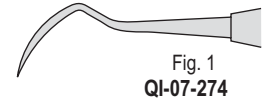
Standard



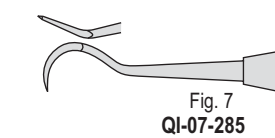
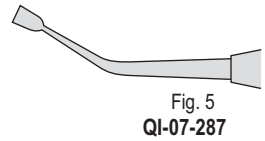
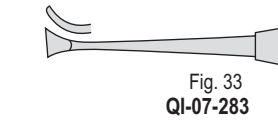
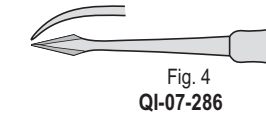
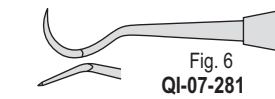
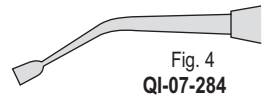
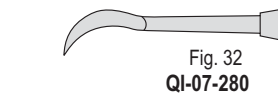
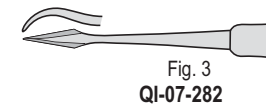
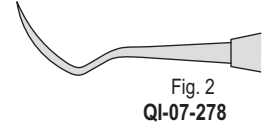
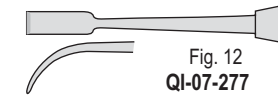
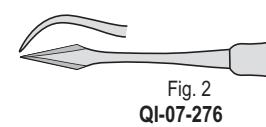
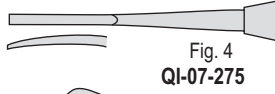
Standard



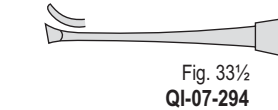
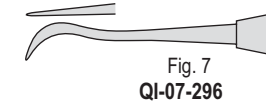
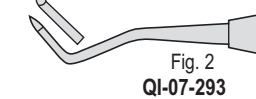
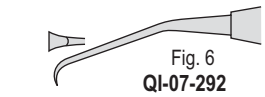
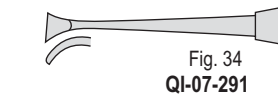
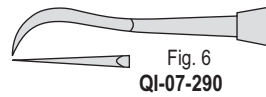
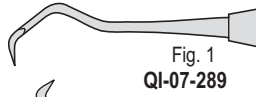
MRU Palma



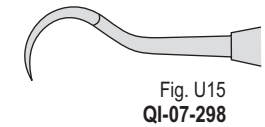
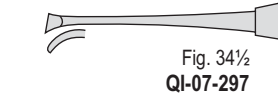
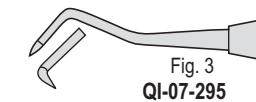
Hygienist



Jacquette



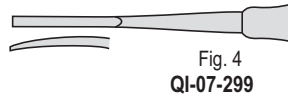
Towner



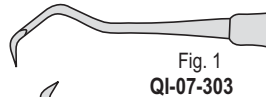
Hollow Handle 8mm



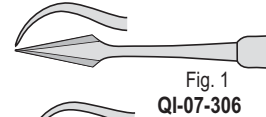
Hygienist



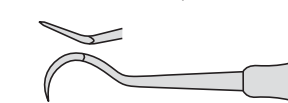
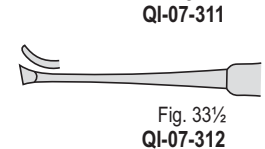
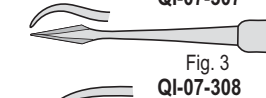
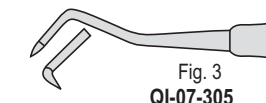
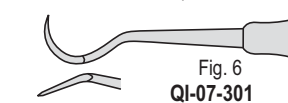
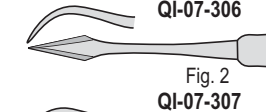
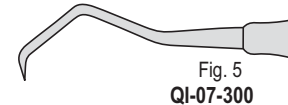
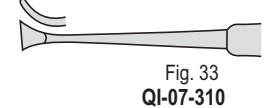
Jacquette



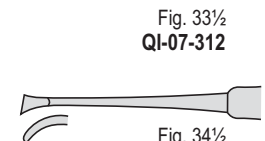
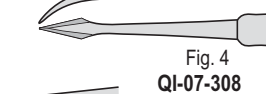
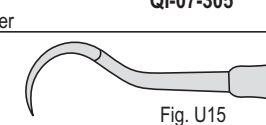
Standard



Standard



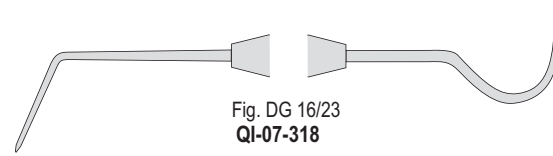
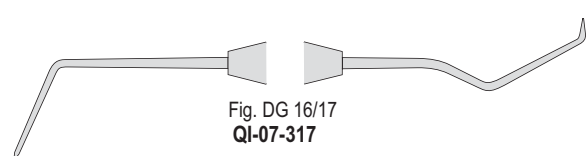
Towner



Endodontic explorers

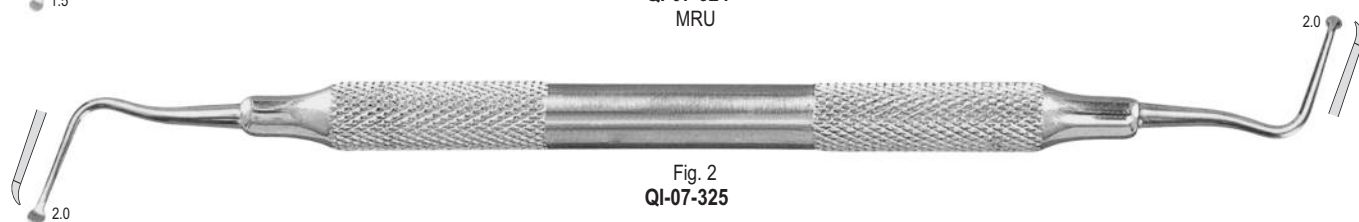
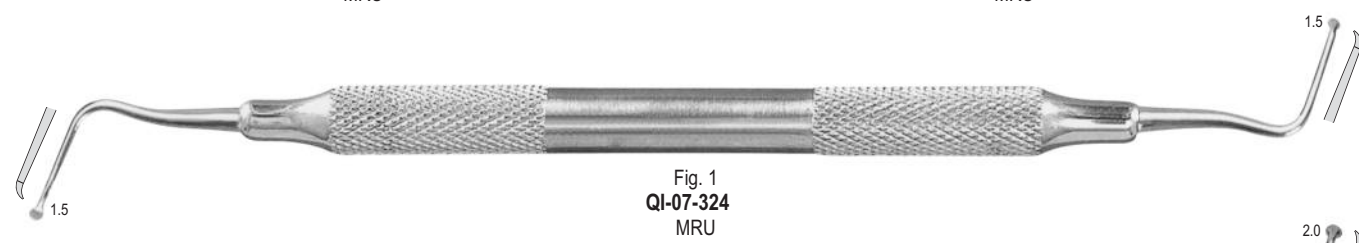
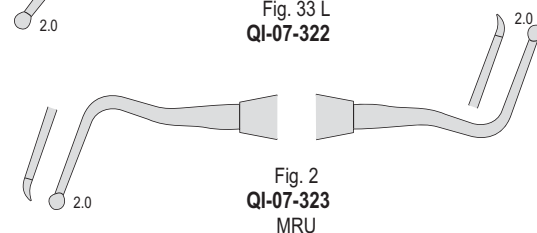
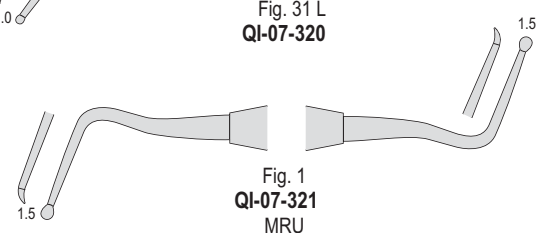
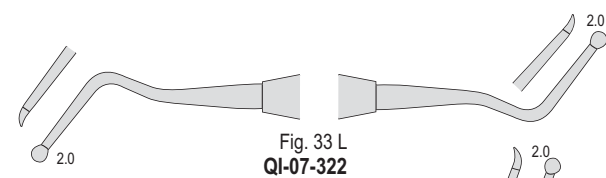
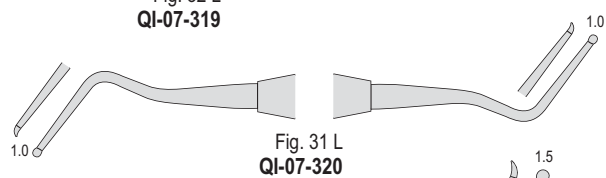
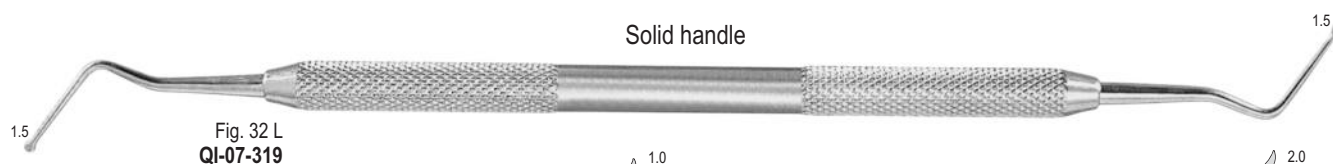


Solid handle

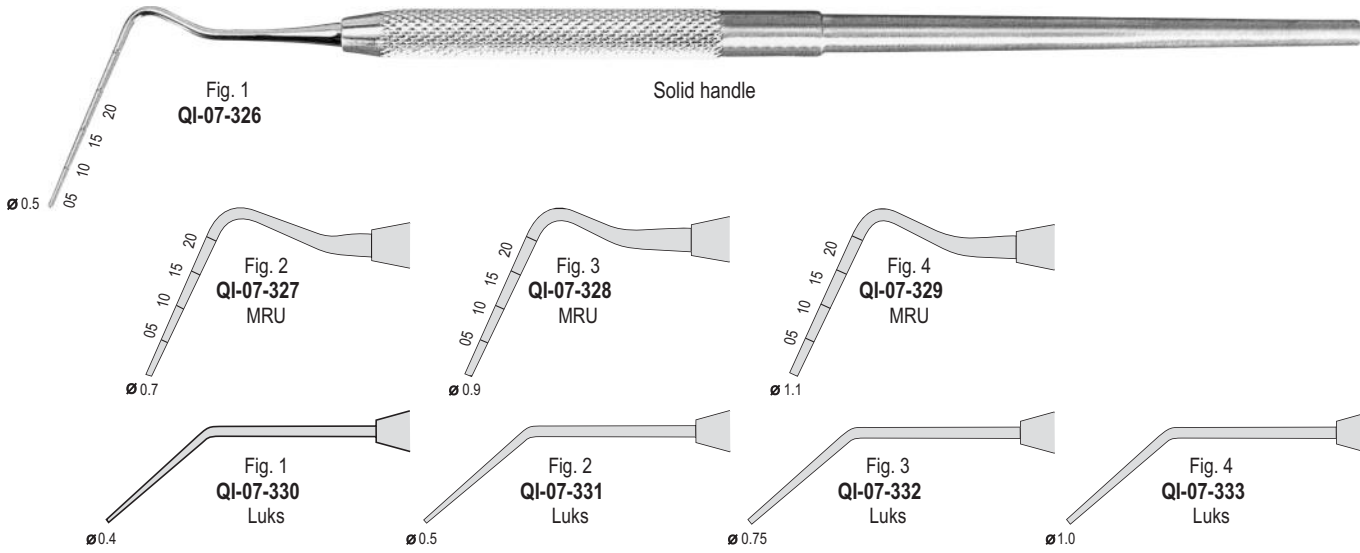


Endodontic excavators

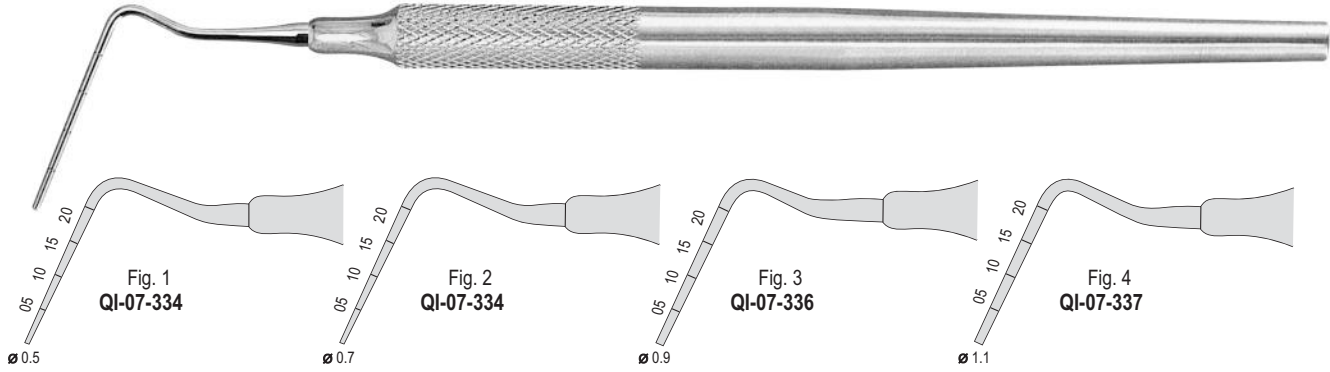
Solid handle



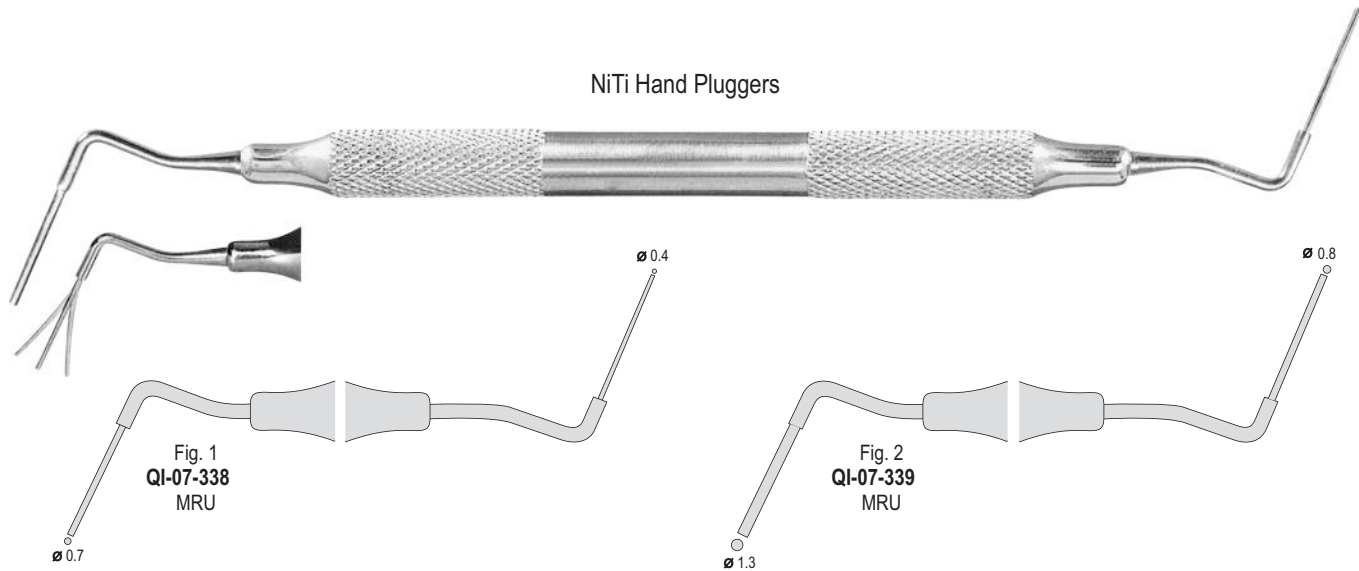
Hand Pluggers



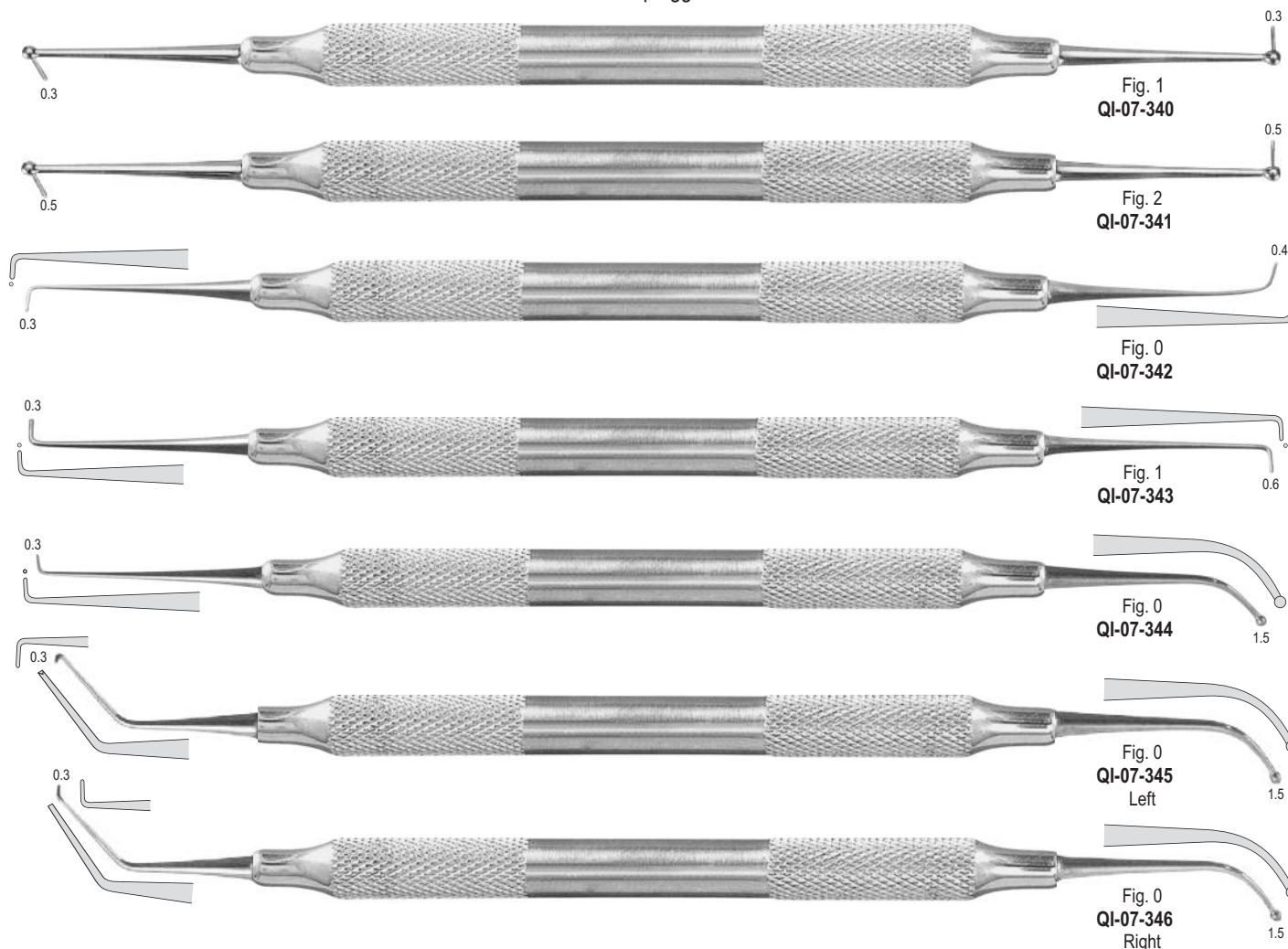
Hollow handle 8mm



NiTi Hand Pluggers

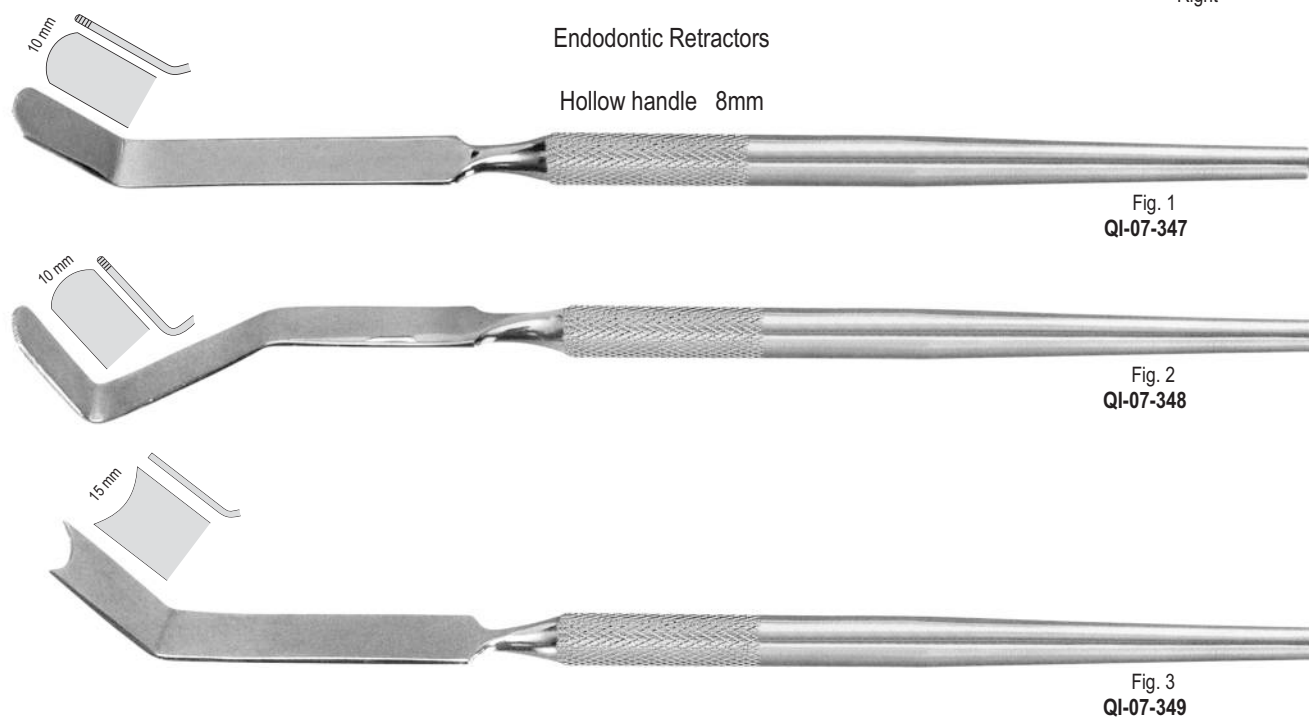


Micro endodontic pluggers/burnishers

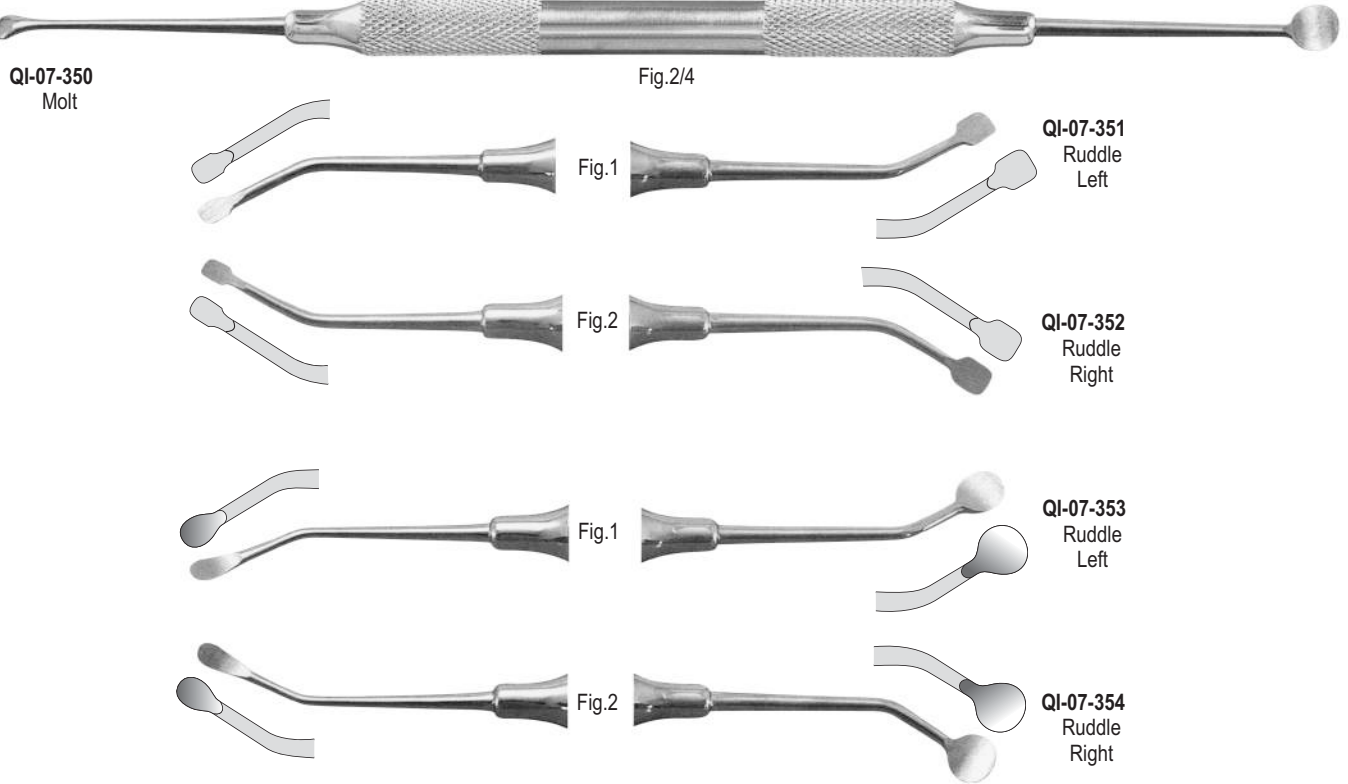


Endodontic Retractors

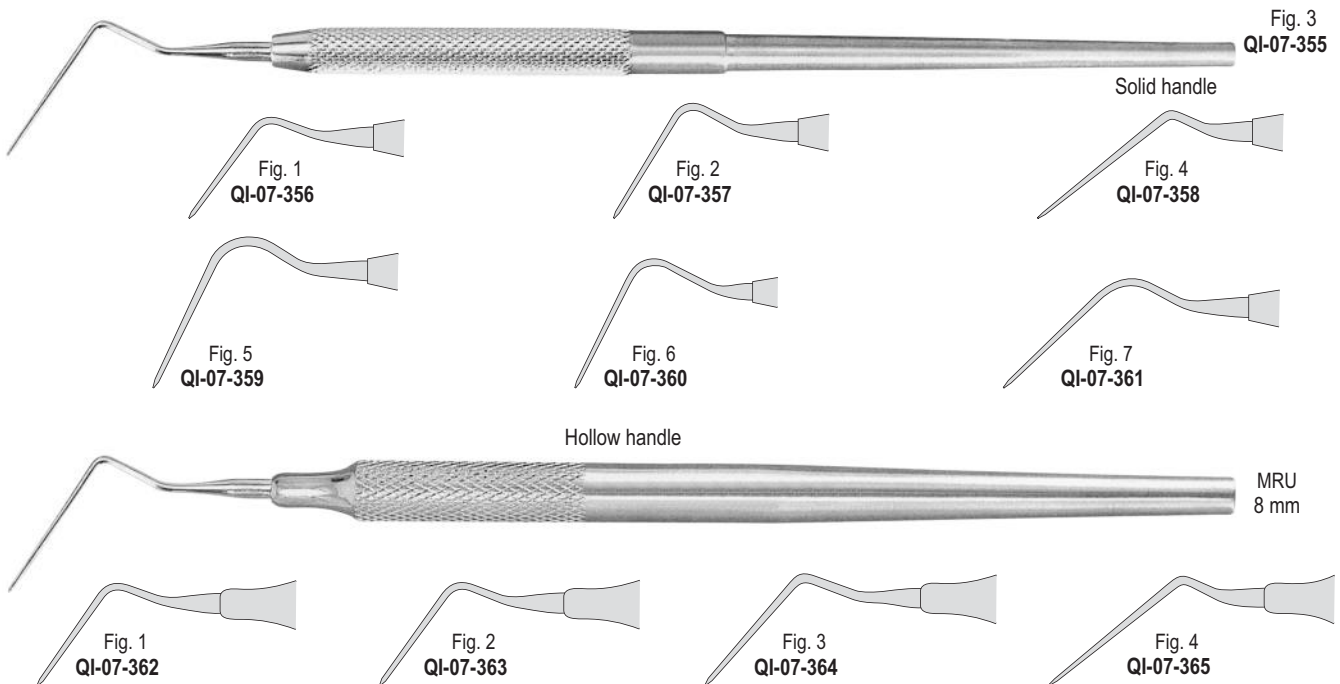
Hollow handle 8mm



Endodontic Curettes

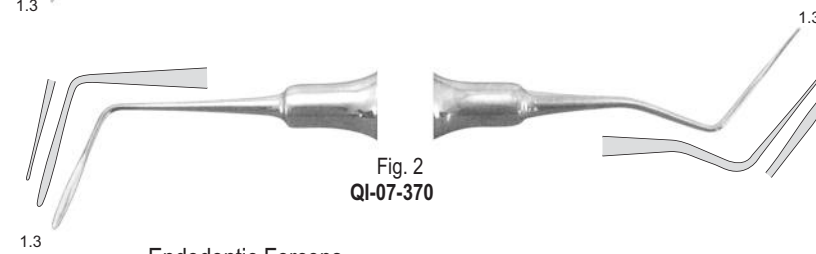
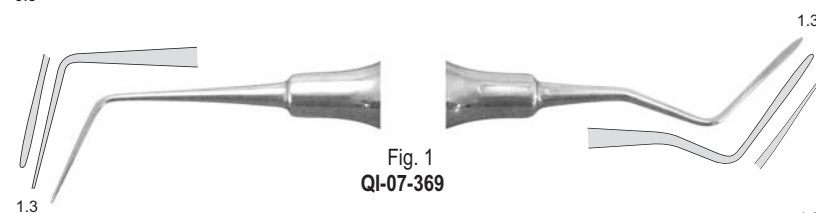
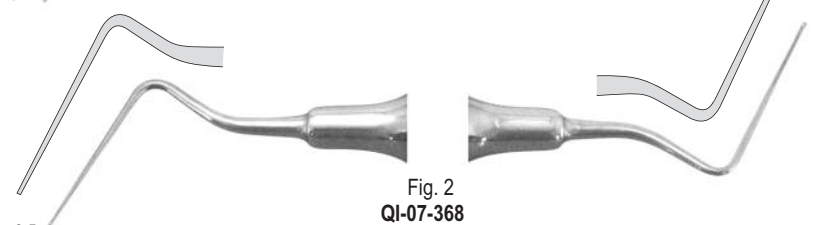
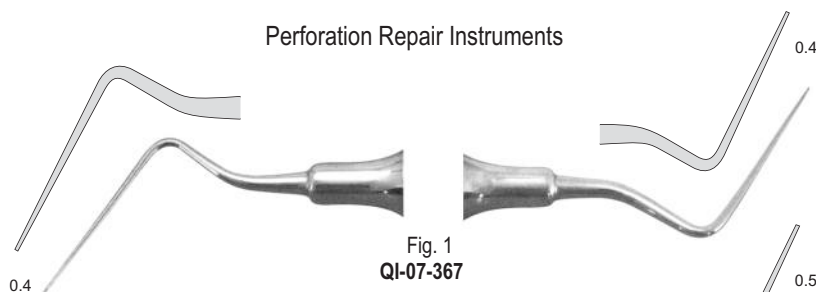


Hand Spreaders





Perforation Repair Instruments



Endodontic Forceps

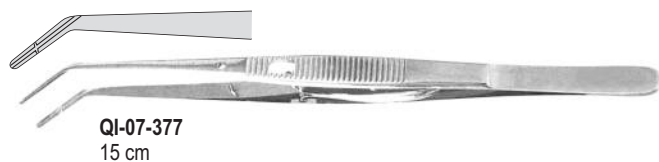
Micro forceps for removing broken files



Silver points and broken files removing forceps



Endodontic Tweezers



Silicone Handle, Ultra Light weight, Non-stick tips, TiN coated

**Pluggers**



Fig. 5A QI-07-378



Fig. 3 QI-07-379 Hollenback



Fig. 1 QI-07-380 Super



Fig. OT QI-07-381 Tanner



Fig. 0/1 QI-07-382



Fig. 1/2 QI-07-383



Fig. 21B QI-07-384 Acorn/Wescott



Fig. 1 QI-07-385 Contact Former



Fig. 2 QI-07-386 Contact Former

**Burnishers**



Fig. 2 QI-07-387 Ladmore



Fig. 3 QI-07-388 Ladmore



Fig. 27/29 QI-07-389



Fig. 1 QI-07-390



Fig. 1L QI-07-391



Fig. 155 QI-07-392



Fig. 156(A6) QI-07-393



Fig. 8A QI-07-394



Fig. 1 QI-07-395 Boghosian





Fig. 2 QI-07-396 Boghosian



Fig. 1 QI-07-397 MRU



Fig. 2 QI-07-398 MRU



Fig. 1 QI-07-399 Goldstein



Fig. 2 QI-07-400 Goldstein



Fig. 3 QI-07-401 Goldstein



Fig. 4 QI-07-402 Goldstein



Fig. 1 QI-07-403 Goldstein-Mini



Fig. 3 QI-07-404 Goldstein-Mini



Fig. 4 QI-07-405 Goldstein-Mini



Fig. 1 QI-07-406 Goldstein-Micro



Fig. 4/5 QI-07-407 Gregg



Fig. 0 QI-07-408 Heidemann



Fig. 1 QI-07-409 Heidemann



Fig. 2 QI-07-410 Heidemann

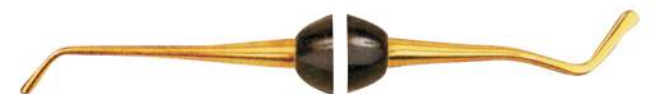


Fig. W3 QI-07-411



Fig. 1 QI-07-412



Fig. 6 QI-07-413



Fig. 178 QI-07-414

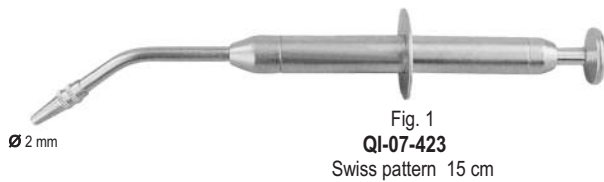
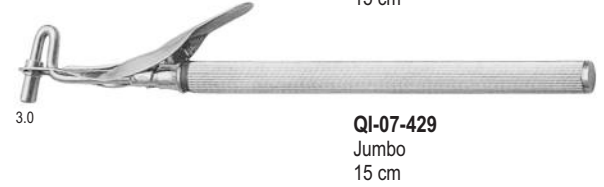
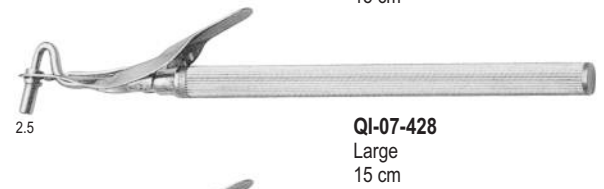
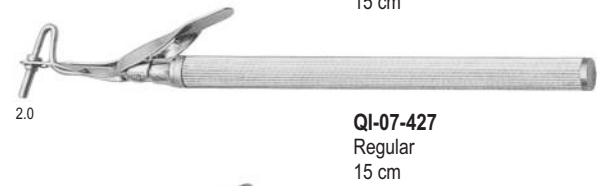
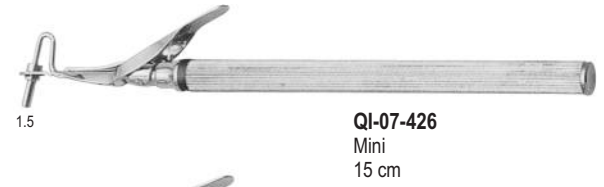
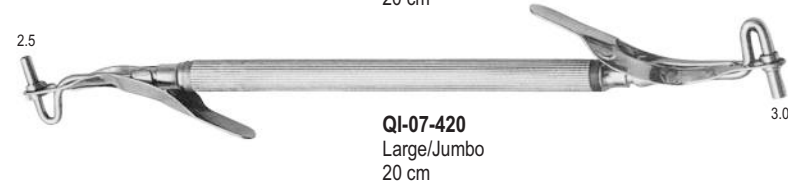
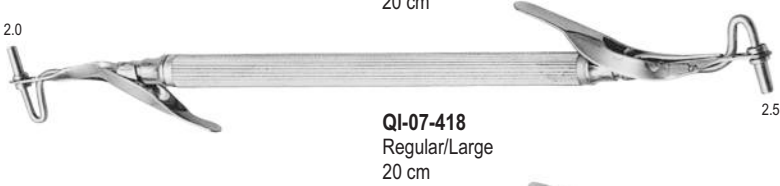


Fig. 49 QI-07-415



Fig. 179 QI-07-416

Amalgam Carriers



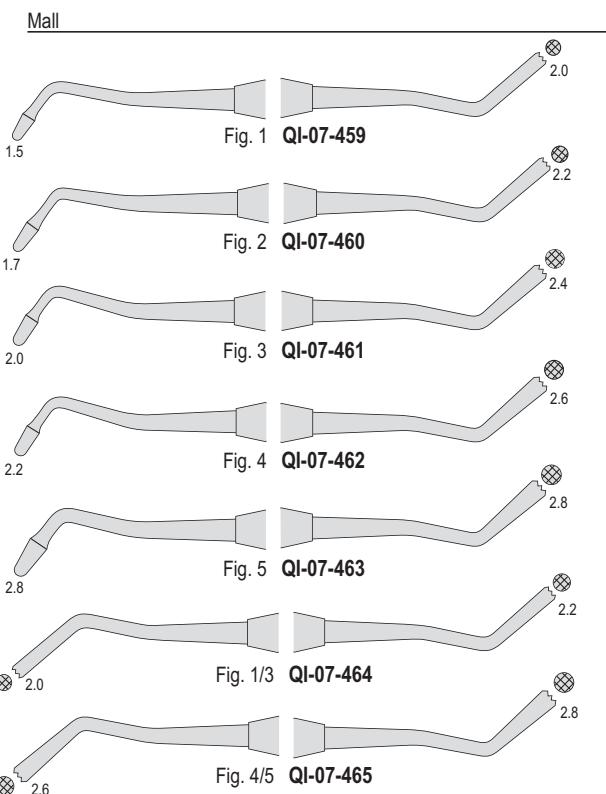
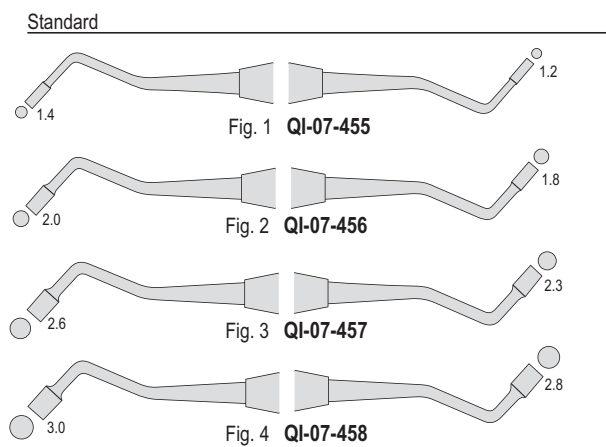
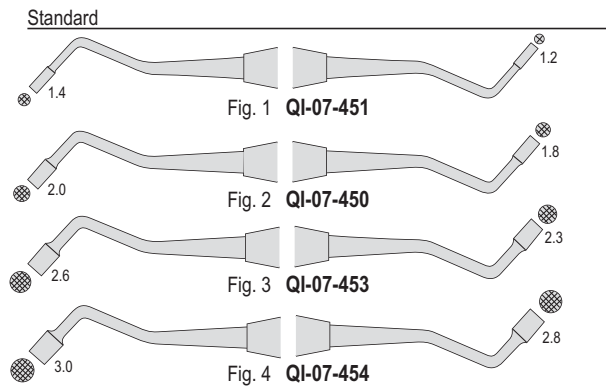
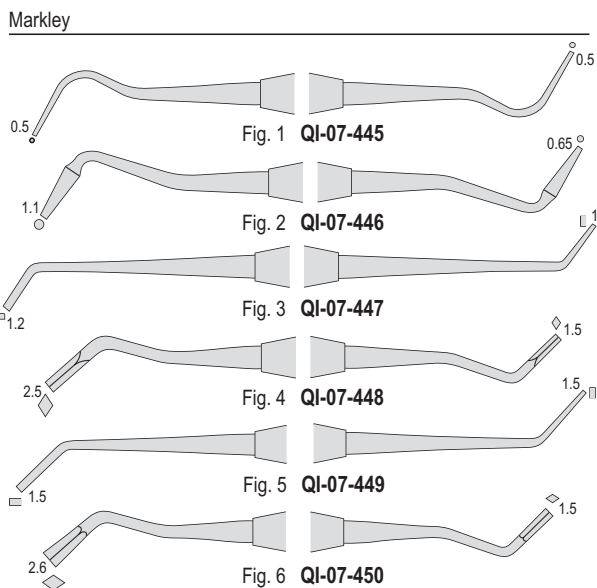
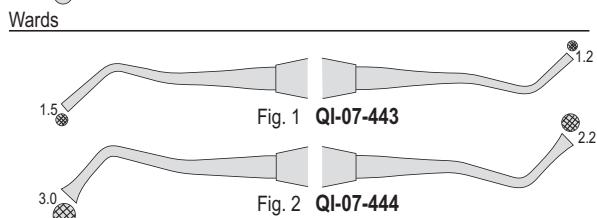
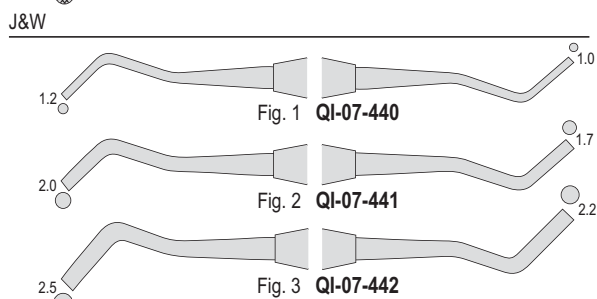
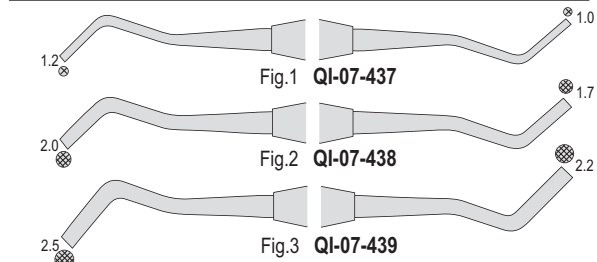
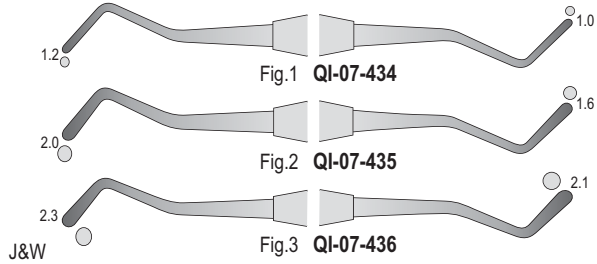
For micro filling



Amalgam well



Solid handle



Super Plugger Hollow 8 mm

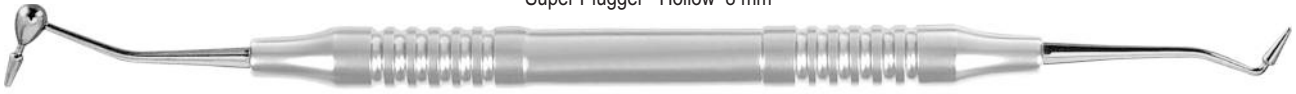
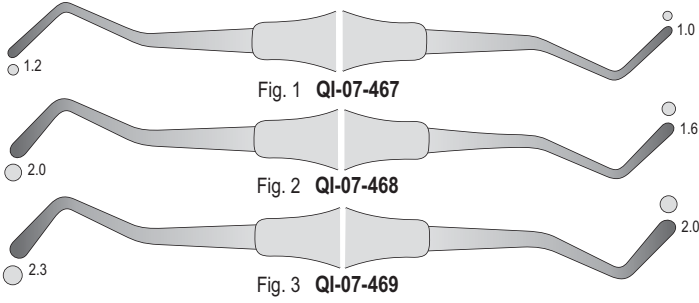
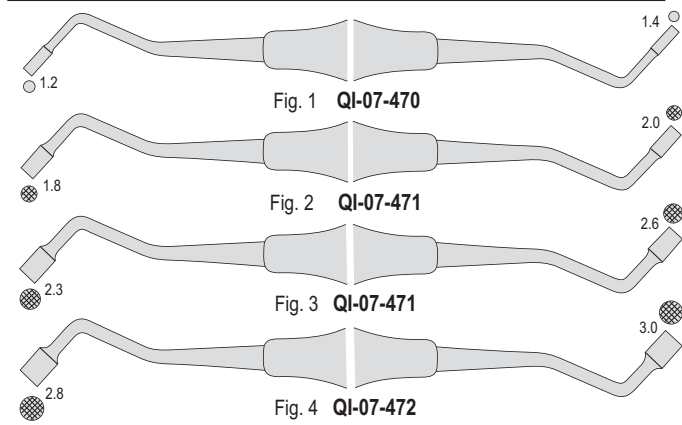


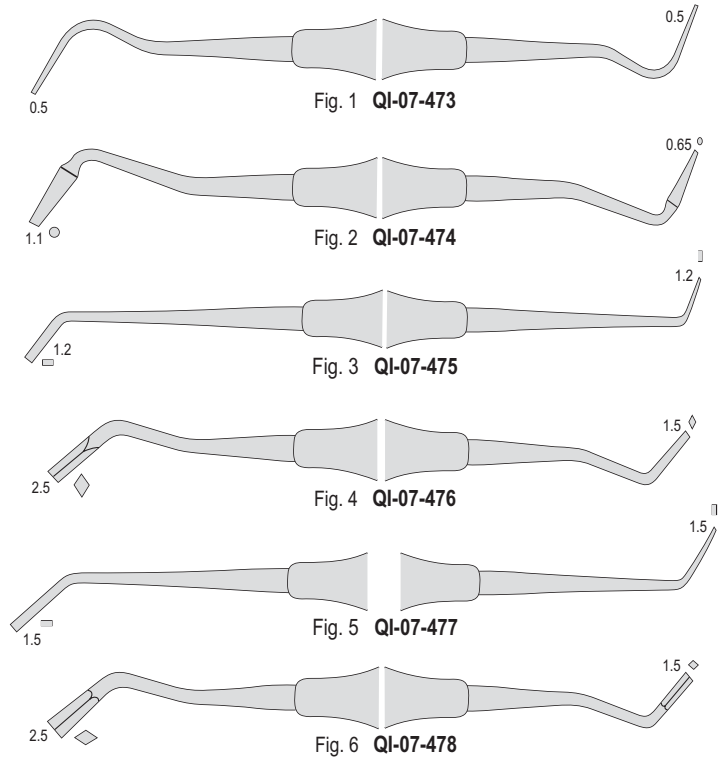
Fig. 1 **QI-07-466**



J&W



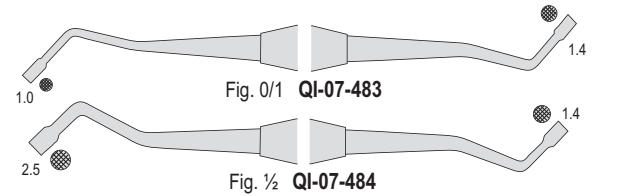
Markley



Solid handle

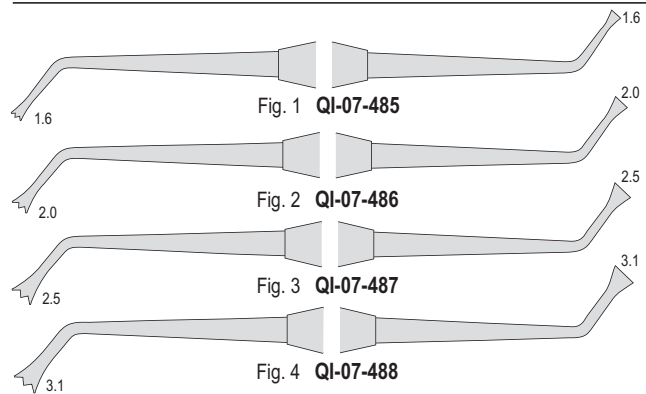
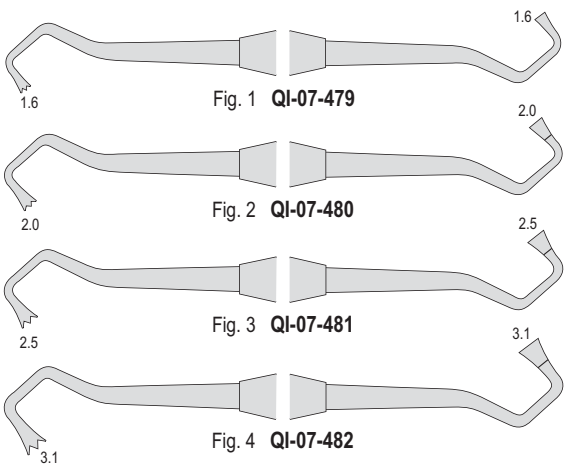


Black



J&W Palma

J&W Palma



Hollow handle 8 mm



Acorn / Wescott

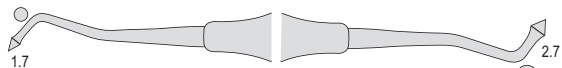


Fig. 21 **QI-07-489**

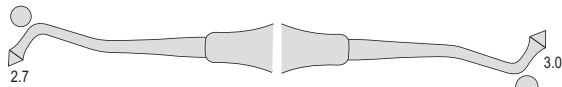


Fig. 21B **QI-07-490**

White

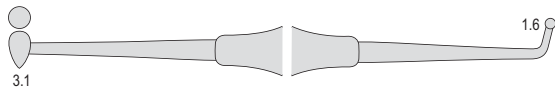


Fig. 27/29 **QI-07-491**

Freedman



Fig. 3 **QI-07-492**

J&W



Fig. 0 **QI-07-493**



Fig. 1 **QI-07-494**



Fig. 2 **QI-07-495**



Fig. 3 **QI-07-496**



Fig. 4 **QI-07-497**



Fig. 5 **QI-07-498**

Solid Handle



J&W Palma

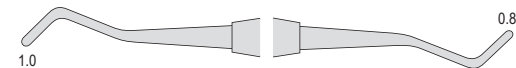


Fig. 1 **QI-07-499**

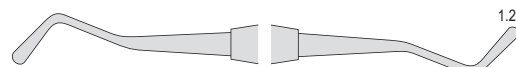


Fig. 2 **QI-07-500**



Fig. 3 **QI-07-501**



Fig. 1 **QI-07-502**



Fig. 1L **QI-07-503**



Fig. 18 **QI-07-504**

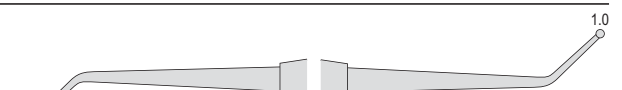


Fig. 1 **QI-07-505**

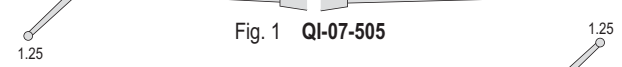


Fig. 2 **QI-07-506**



Fig. 3 **QI-07-507**

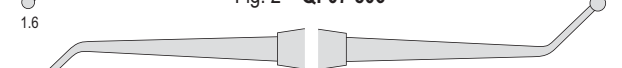


Fig. 4 **QI-07-508**

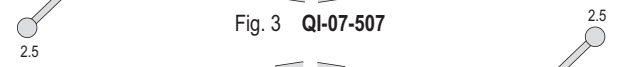


Fig. 1 **QI-07-509**



Fig. 2 **QI-07-510**

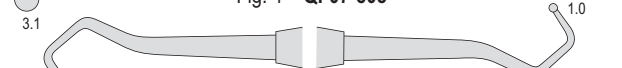


Fig. 2 **QI-07-510**

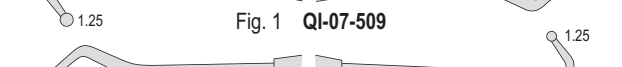


Fig. 3 **QI-07-511**



Fig. 3 **QI-07-511**

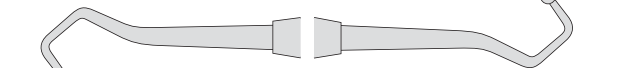
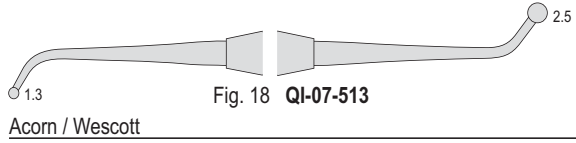
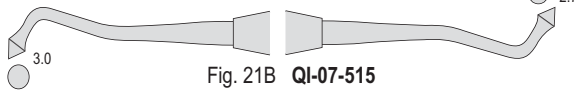
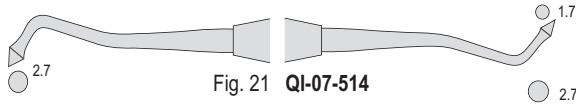


Fig. 4 **QI-07-512**

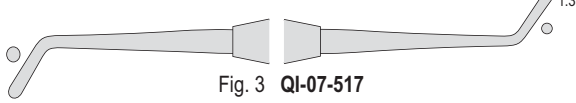
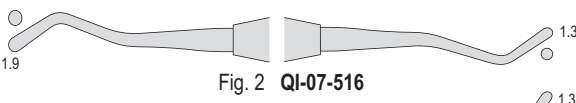
Solid handle



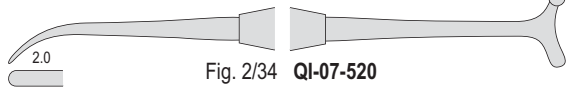
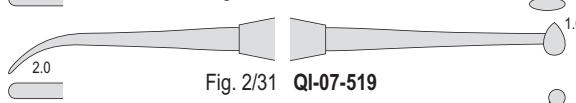
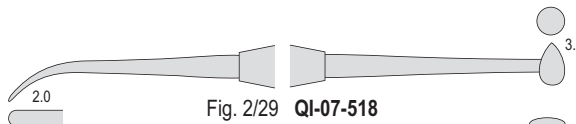
Acorn / Wescott



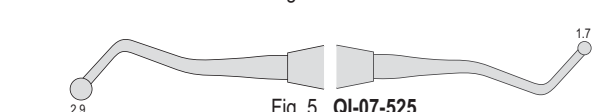
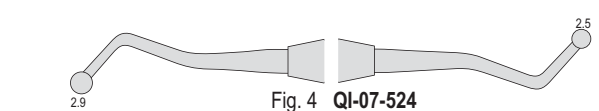
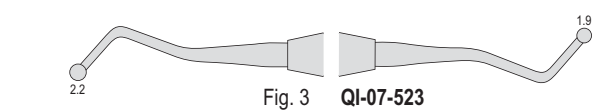
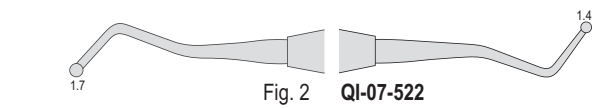
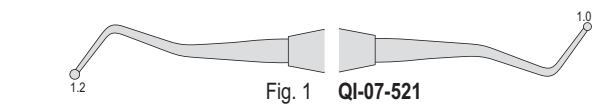
Ladmore



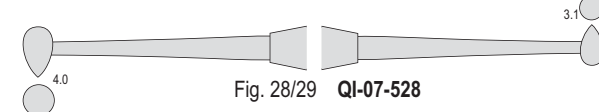
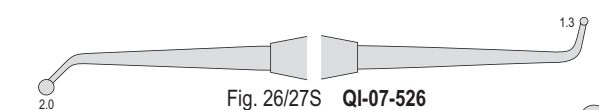
Beavertail / White



J&W

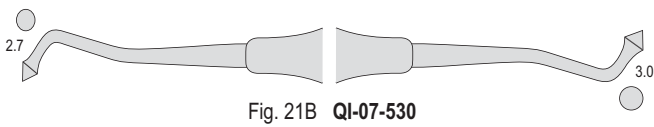
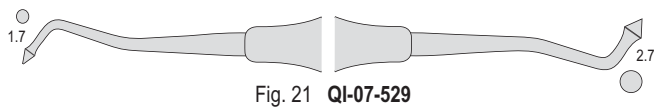


White

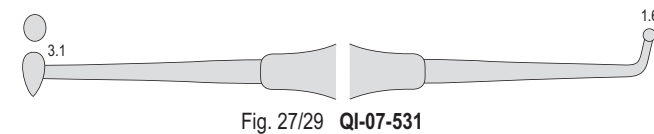


Hollow handle

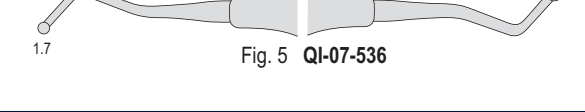
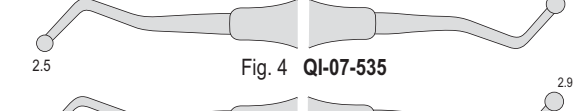
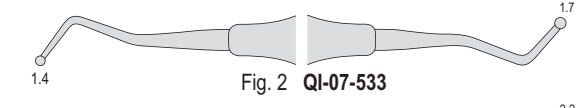
Acorn / Wescott



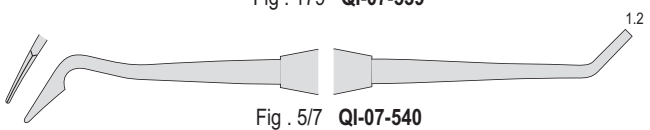
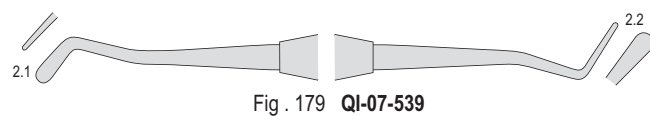
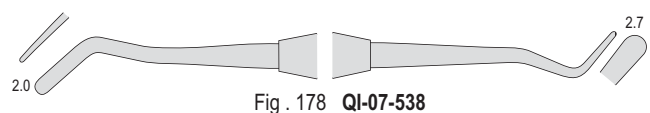
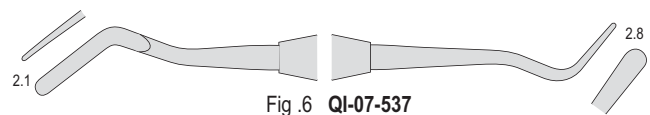
White



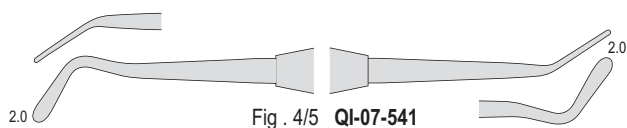
J&W



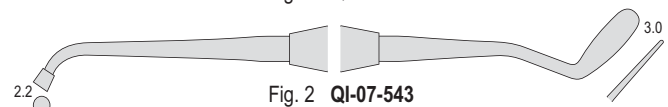
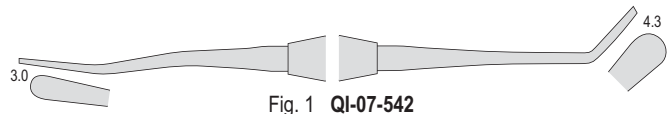
Solid handle



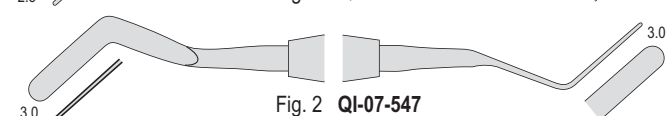
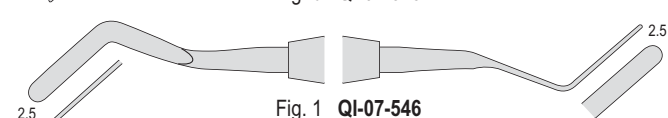
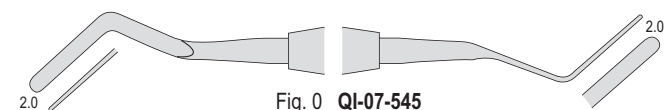
Gregg



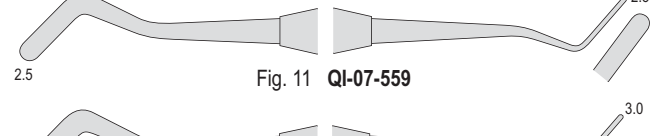
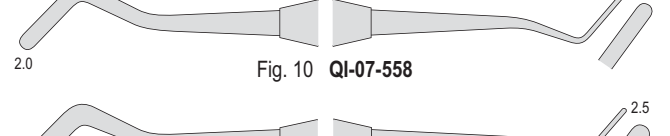
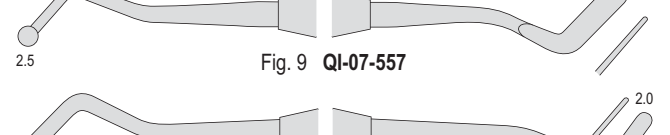
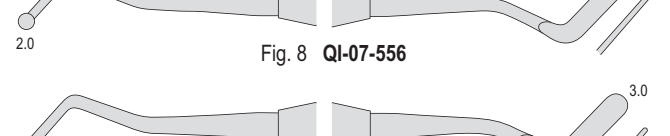
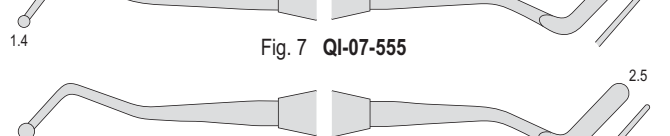
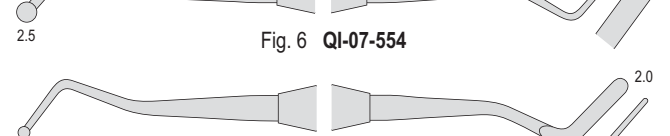
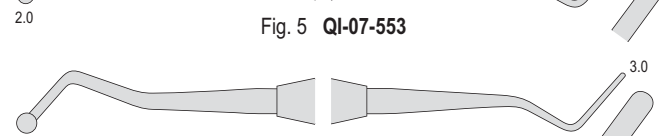
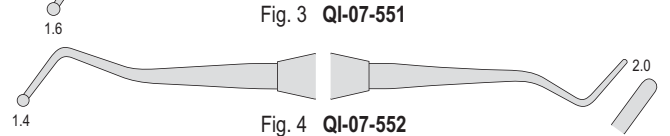
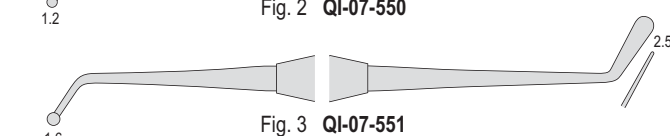
Woodson



Heidemann



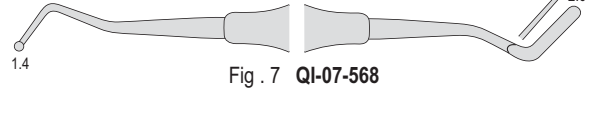
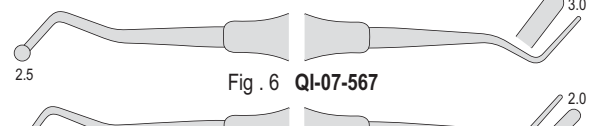
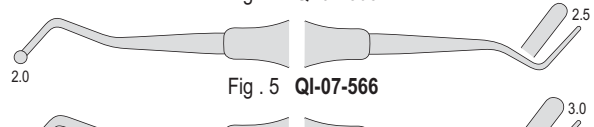
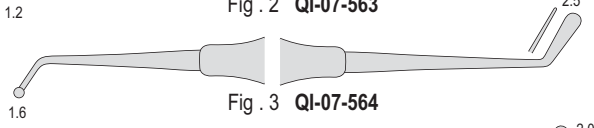
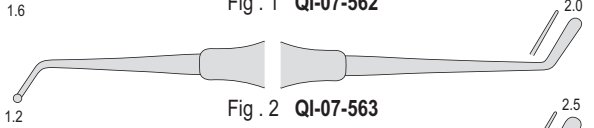
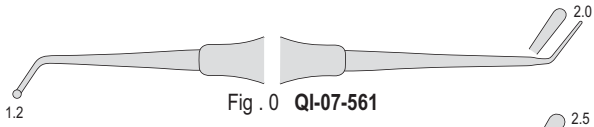
J&W



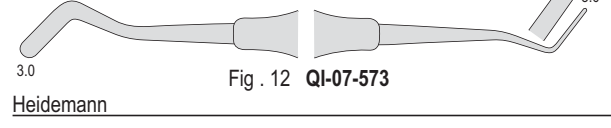
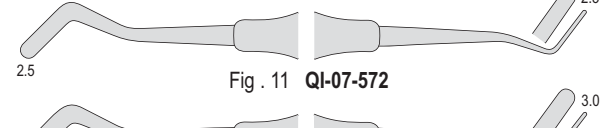
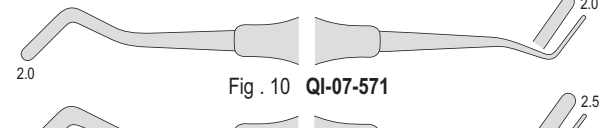
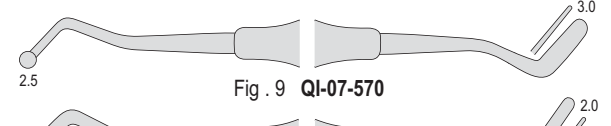
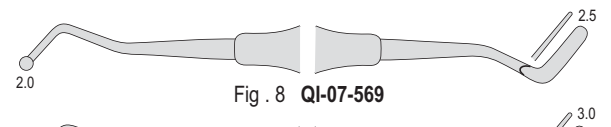
Hollow handle



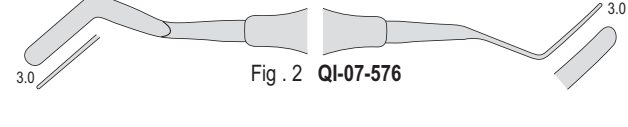
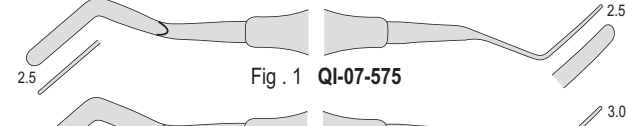
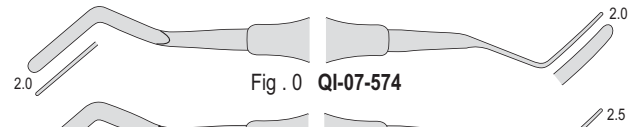
J&W



J&W



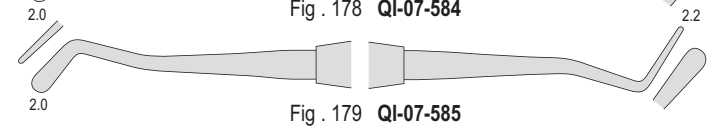
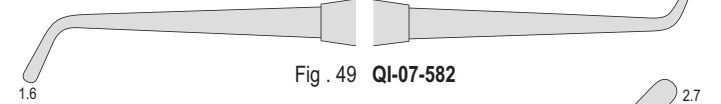
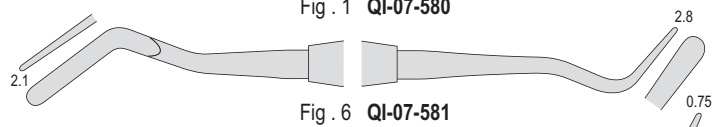
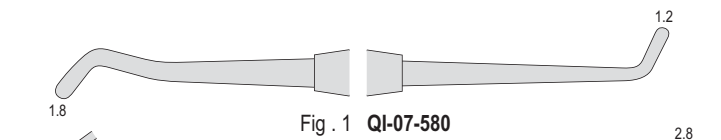
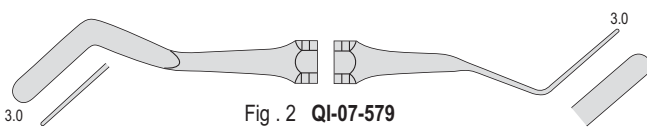
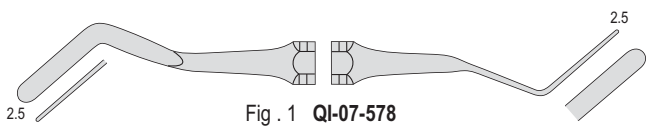
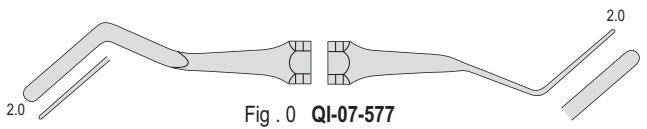
Heidemann



Solid handle



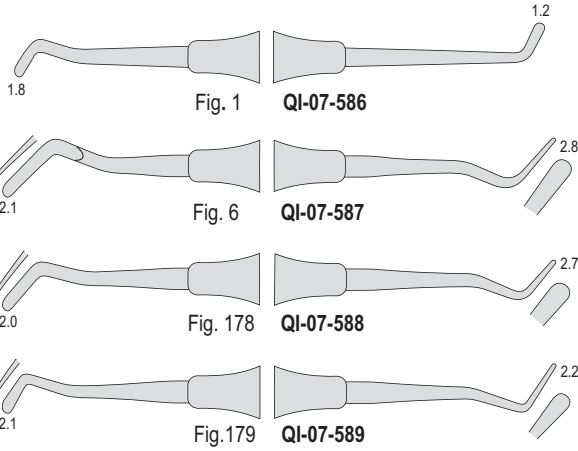
J&W



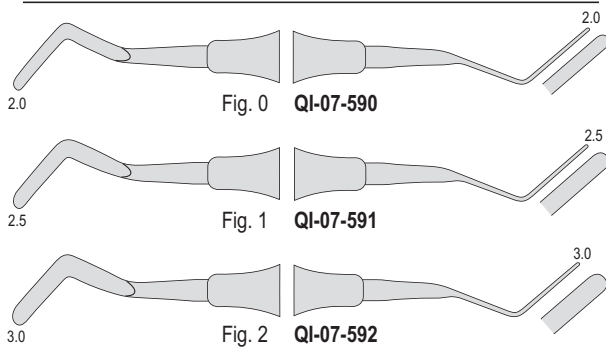




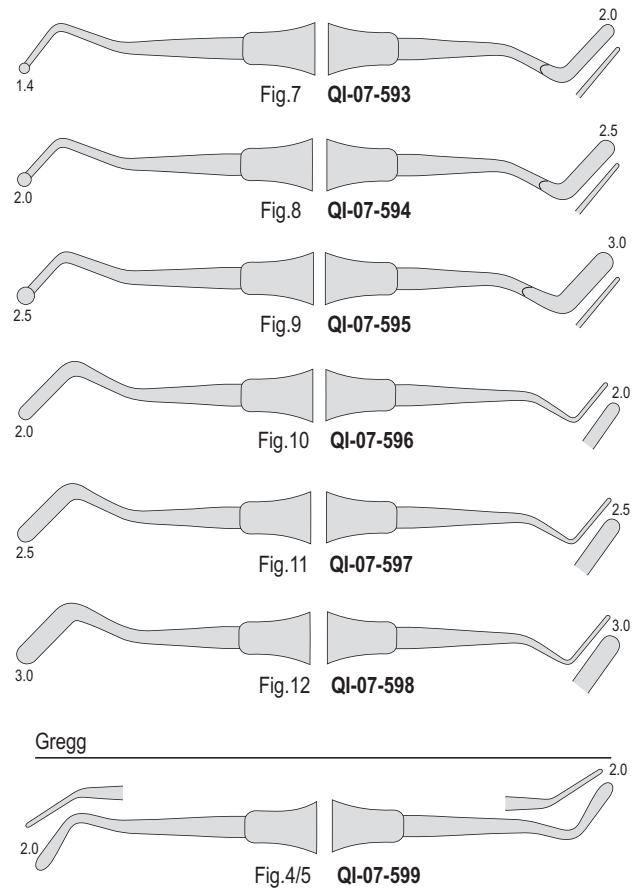
Blue-Yellow



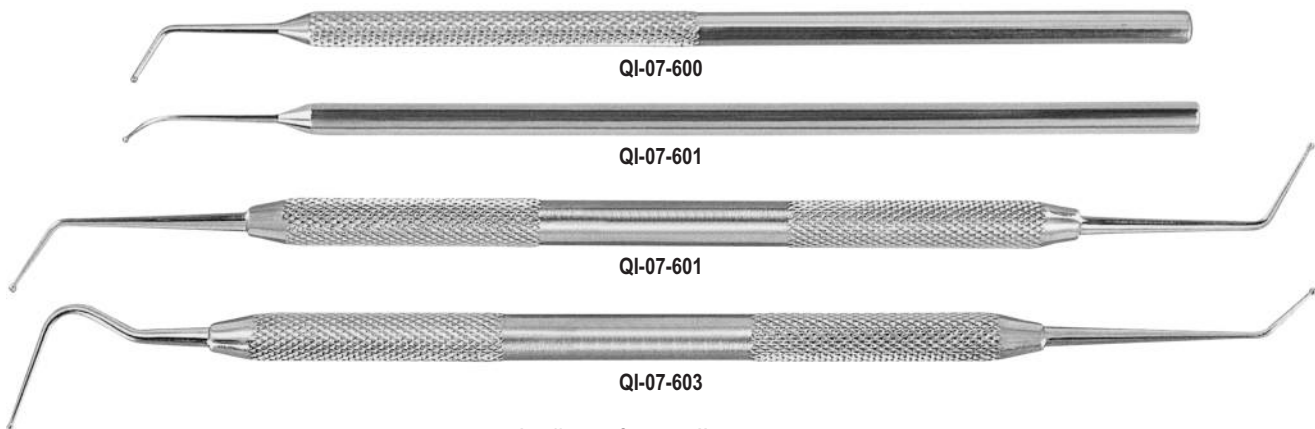
Heidemann



J&W



Applicators for calcium hydroxide



Applicator for medicaments



QI-07-604  
Orban



Blue-Yellow

J&W

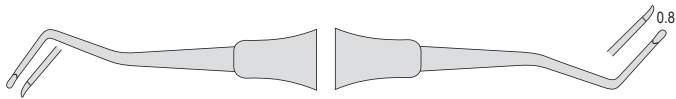


Fig. 0 **QI-07-605**

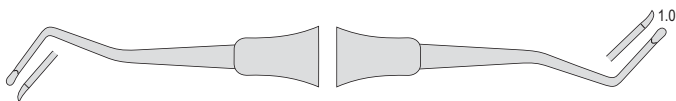


Fig. 1 **QI-07-606**

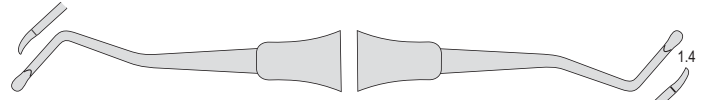


Fig. 2 **QI-07-607**

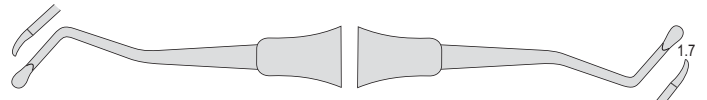


Fig. 3 **QI-07-608**

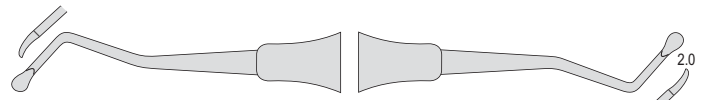


Fig. 4 **QI-07-609**



Solid handle

J&W

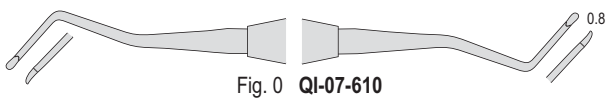


Fig. 0 **QI-07-610**



Fig. 1 **QI-07-611**

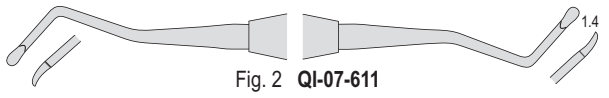


Fig. 2 **QI-07-611**

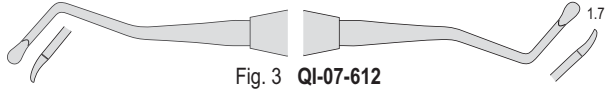


Fig. 3 **QI-07-612**



Fig. 4 **QI-07-613**

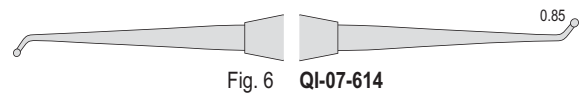


Fig. 6 **QI-07-614**

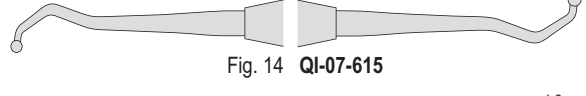


Fig. 14 **QI-07-615**

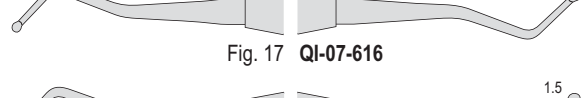


Fig. 17 **QI-07-616**

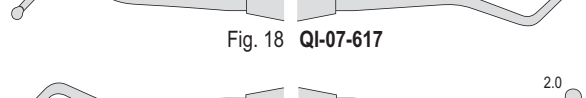


Fig. 18 **QI-07-617**

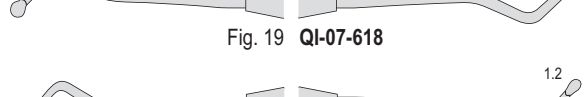


Fig. 19 **QI-07-618**

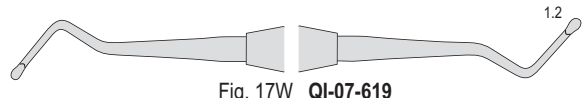


Fig. 17W **QI-07-619**

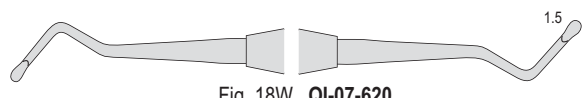


Fig. 18W **QI-07-620**

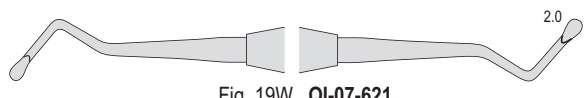
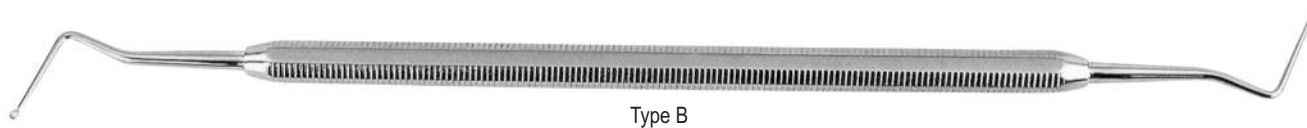
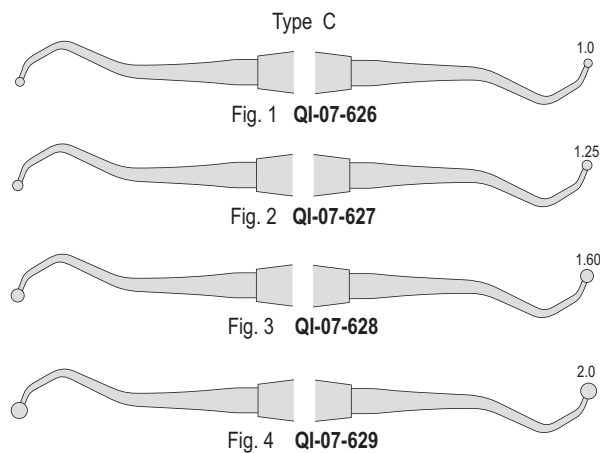
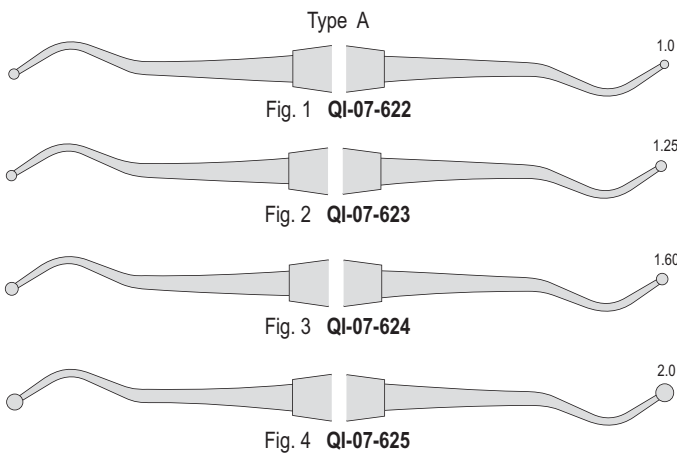


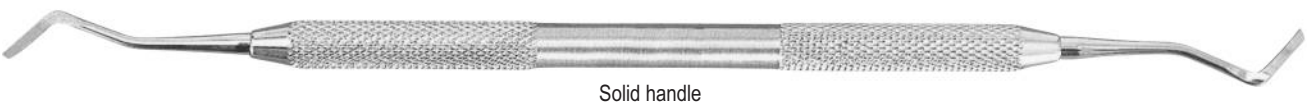
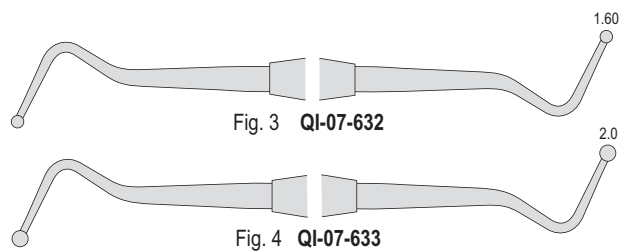
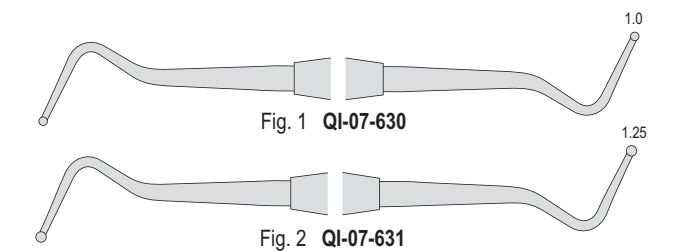
Fig. 19W **QI-07-621**



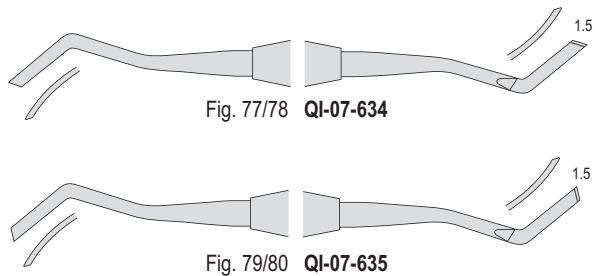
J&W Palma



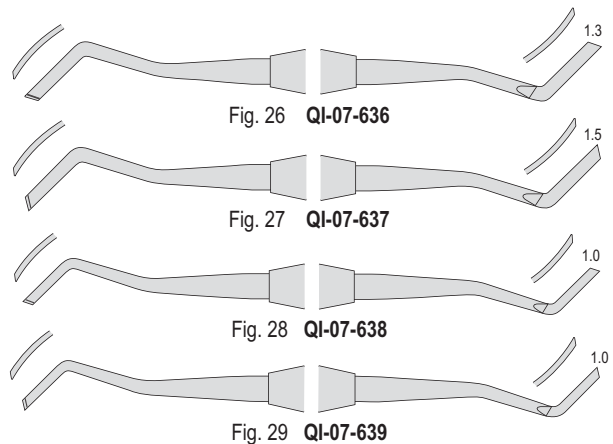
J&W Palma



Blacks



Ferrier



Carvers

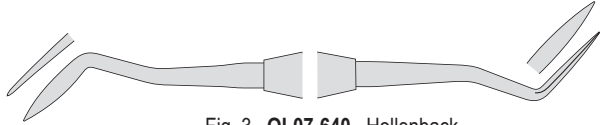


Fig. 3 **QI-07-640** Hollenback

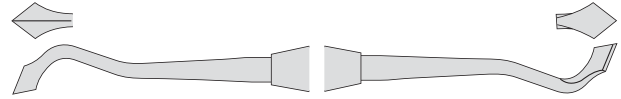


Fig. 2/3 **QI-07-644** Frahm

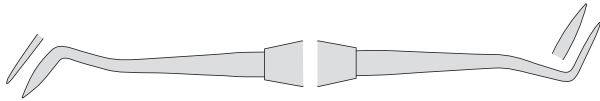


Fig. 4 **QI-07-641** Hollenback

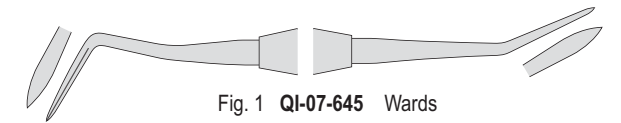


Fig. 1 **QI-07-645** Wards

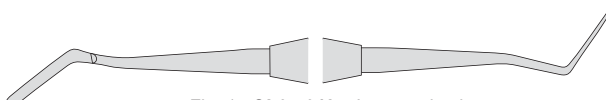


Fig. 1 **QI-07-642** Interproximal

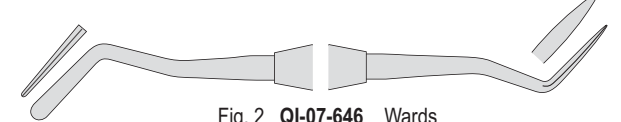


Fig. 2 **QI-07-646** Wards

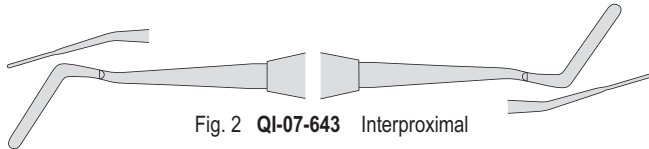


Fig. 2 **QI-07-643** Interproximal

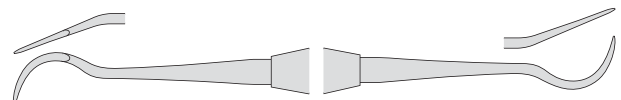


Fig. 8 **QI-07-647** Wiland

Carvers



Fig. 3 **QI-07-648** Hollenback



Fig. 3 1/2 **QI-07-649** Hollenback

Finishing knives



Fig. 2 **QI-07-650** USC



Fig. 2S **QI-07-651** USC



Fig. 28 **QI-07-652** Black



Fig. 29 **QI-07-653** Black

Finishing knives

Hollow handle



Fig. 6T **QI-07-654** Tanner



Fig. 2 **QI-07-655** USC



Fig. 2S **QI-07-656** USC

Cleoid - Discoid

Solid handle

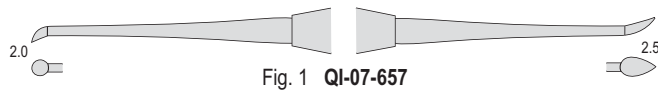


Fig. 1 **QI-07-657**



Fig. 3 **QI-07-659**

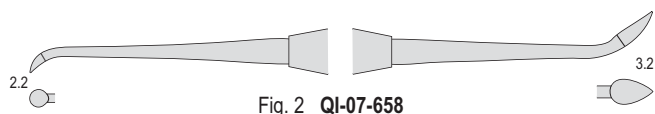


Fig. 2 **QI-07-658**

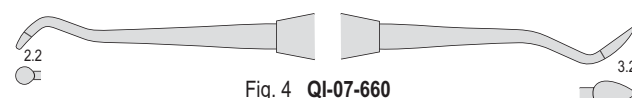


Fig. 4 **QI-07-660**

Cleoid - Discoid

Yellow-Orange

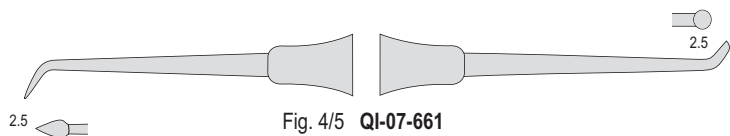


Fig. 4/5 **QI-07-661**

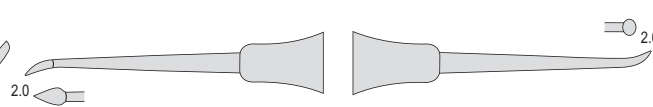


Fig. 89/92 **QI-07-663**

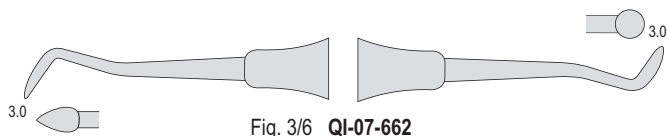


Fig. 3/6 **QI-07-662**

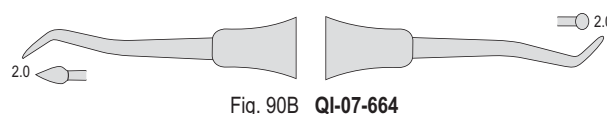


Fig. 90B **QI-07-664**

Filling removing instrument



Fig. 1 **QI-07-665** Yellow-Orange

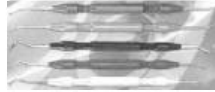
P.K. Thomas



Fig. 1 **QI-07-666** Green



Fig. 2 **QI-07-667** Yellow



**54-B**  
Set of 5 Pieces



Fig. 4 **QI-07-669** Orange



Fig. 3 **QI-07-668** Blue



Fig. 5 **QI-07-670** Silver



Fig. 1 **QI-07-671**



Fig. 2 **QI-07-672**



**QI-07-676**  
P.K. Thomas  
Set of 5 Pieces



Fig. 4 **QI-07-674**



Fig. 3 **QI-07-673**



Fig. 5 **QI-07-675**



Fig. 7 **QI-07-677** Beale



Fig. 31 **QI-07-678** Gritman



Fig. 10 **QI-07-680** Lecron



Fig. 10 **QI-07-679** Hylin



Fig. 10 **QI-07-681** Zahle



Fig. 1 **QI-07-682** Vehe



Fig. 31 **QI-07-683** Gritman



Fig. 13 **QI-07-685**



Fig. 12 **QI-07-684**



Fig. 1 **QI-07-686** Beale



Fig. 1 **QI-07-687** Roach

Akers Carver



**QI-07-688** Akers Complete



**QI-07-689** Spoon Only

54-493-00 Handle Only

**QI-07-690** Knife Tip Only



Fig. 1 13 cm

Fig. 2 14 cm

Fig. 3 14 cm

Fig. 4 13.5 cm

Fig. 5 14 cm

Fig. 6 11.7 cm

Fig. 7 11.5 cm

Fig. 1 Zahle 12 cm

Fig. 2 Zahle 12.5 cm

Fig. 3 Zahle 12.5 cm

Fig. 4 Zahle 12 cm

Fig. 5 Zahle 12 cm

Fig. 6 Zahle 11.5 cm

QI-07-691 QI-07-692 QI-07-693 QI-07-694 QI-07-695 QI-07-696 QI-07-697 QI-07-698 QI-07-699 QI-07-700 QI-07-701 QI-07-702 QI-07-703



Fig. 1 Hylin 13.5 cm

Fig. 3 Hylin-Ceramica 13.5 cm

Fig. 5 Hylin 13.5 cm

Fig. 6 Hylin-Lecron 13.5 cm

Fig. 1 Lecron-mini 10 cm

Fig. 2 Lecron-mini 13 cm

Fig. 3 Lecron-mini 13 cm

Fig. 1 Lecron 16.5 cm

Fig. 2 Lecron 16.5 cm

Fig. 3 Lecron 16.5 cm

Fig. 4 Lecron 16.5 cm

Fig. 7 Lecron 16 cm

Fig. 8 Lecron 16 cm

QI-07-704 QI-07-705 QI-07-706 QI-07-707 QI-07-708 QI-07-709 QI-07-710 QI-07-711 QI-07-712 QI-07-713 QI-07-714 QI-07-715 QI-07-716



Fig. 1 **QI-07-717** Hollow handle



Fig. 2 **QI-07-718** Hollow handle



Fig. 3 **QI-07-719** Solid handle



Fig. 1 **QI-07-720** Solid handle



Fig. 2 **QI-07-721** Solid handle



Fig. 3 **QI-07-722**



Fig. 00 **QI-07-723**



Fig. 0 **QI-07-724**

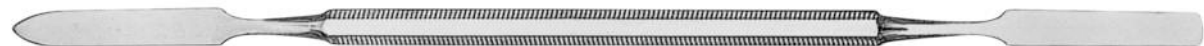


Fig. 1 **QI-07-725**



Fig. 2 **QI-07-726**

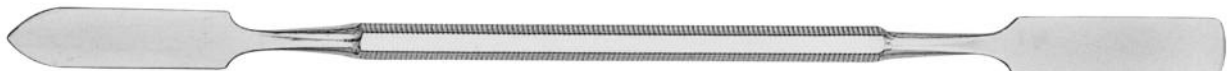


Fig. 3 **QI-07-727**



Fig. 4 **QI-07-728**



Weston **QI-07-729**

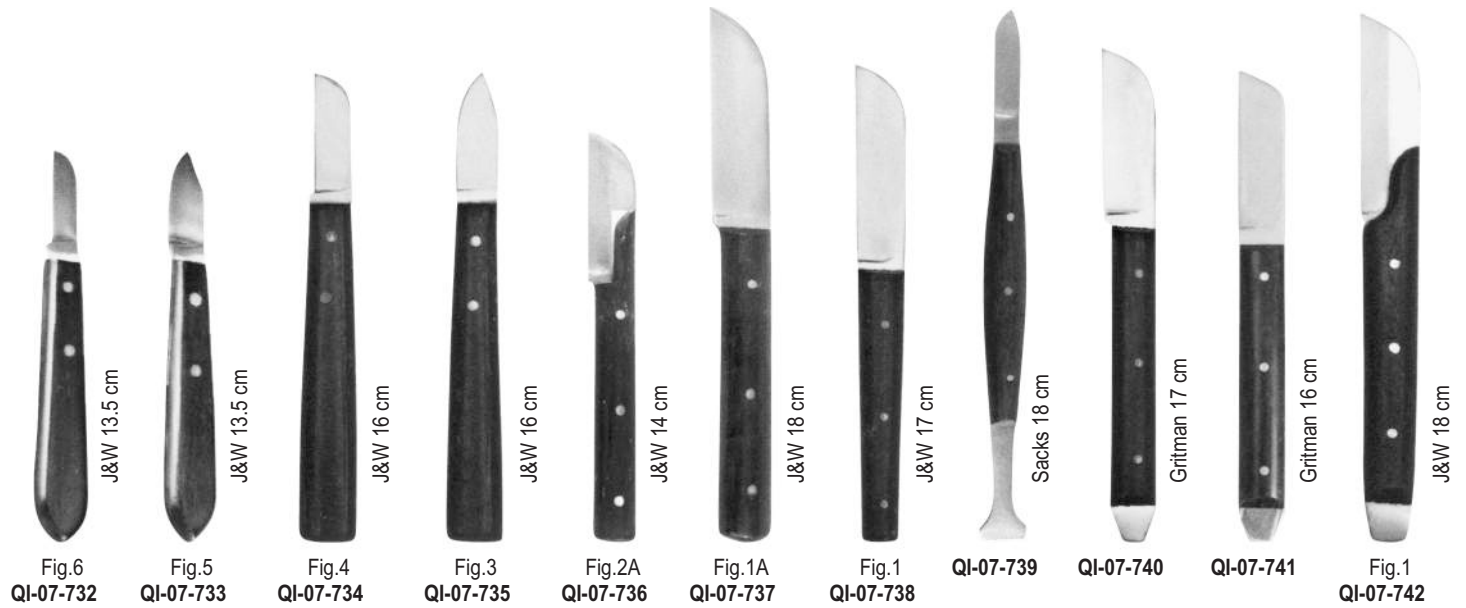


**QI-07-730**



**QI-07-731**

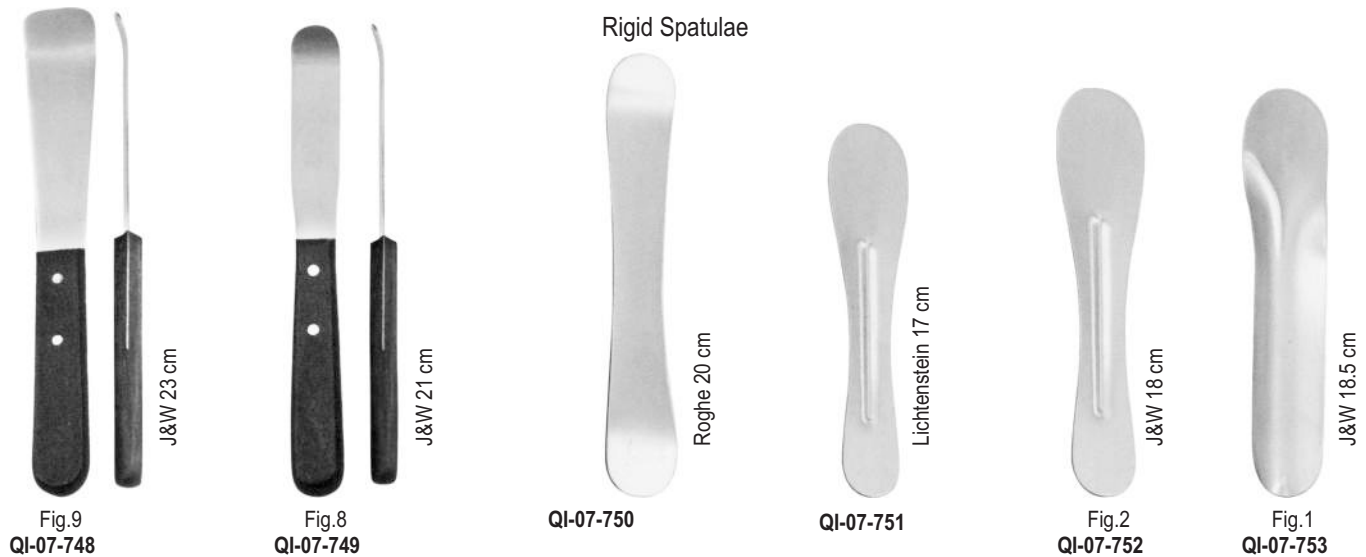




Flexible Spatulae



Rigid Spatulae



Wax knives with plastic handle  
(Available in different colours)



QI-07-754 Fahnestock 13 cm



QI-07-756 Lessmann 13 cm



QI-07-755 Fahnestock 17.5 cm



QI-07-757 Lessmann 17.5 cm

Wax knives with wooden handle



QI-07-758 Fahnestock 13 cm



QI-07-760 Lessmann 13 cm



QI-07-759 Fahnestock 17.5 cm



QI-07-761 Lessmann 17.5 cm



QI-07-762 with spoon 13 cm



QI-07-763 with spoon 17.5 cm

Wax knives Ermert



QI-07-764 Wooden handle



QI-07-765 Plastic handle



QI-07-766 Metal handle

Wax knives with metal handle



QI-07-767 Fahnestock 13 cm



QI-07-768 Fahnestock 17.5 cm



QI-07-769 Lessmann 13 cm

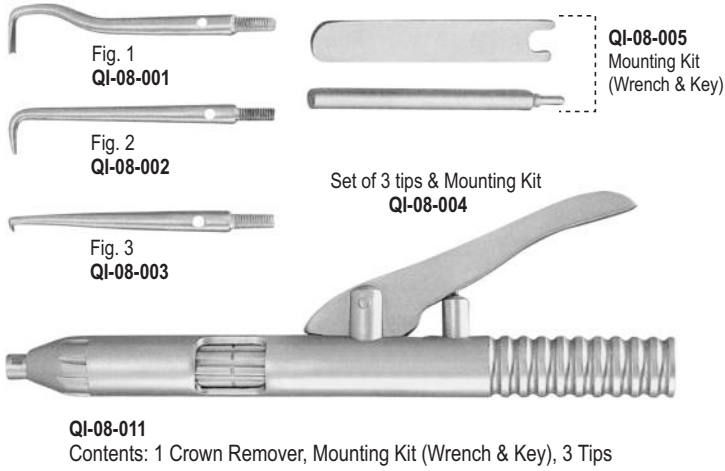


QI-07-770 Lessmann 17.5 cm

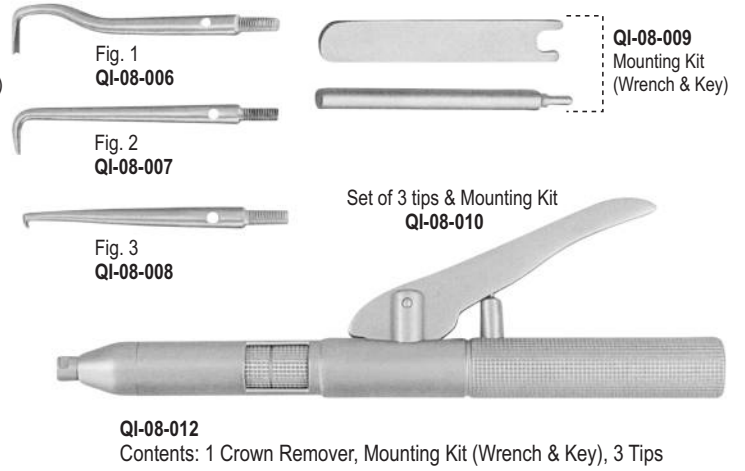
## Crown Removers

Crown Removers & Forceps for Articulating Paper  
Crown Spreaders  
Rubber Dam Instruments  
Matrix Retainers & Rubber Dam Frames  
Ligature & Separators Placing Pliers  
Elastic Ligature Placing Forceps  
Elastic Applicators & Ligature Tuckers  
Bracket Positioning Instruments  
Bracket & Measuring Instruments  
Laboratory Instruments  
Crown Instruments & Grinding Stones  
X - Ray Holders & Laboratory Bowls

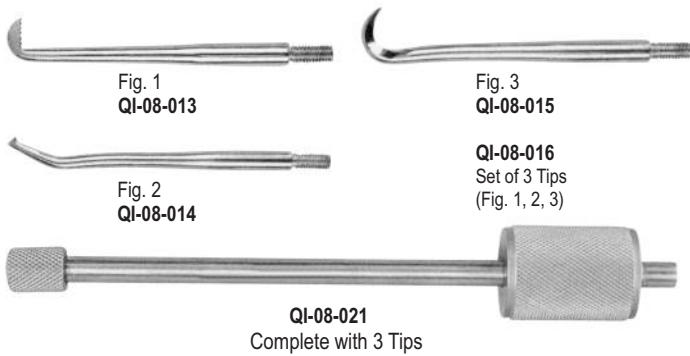
Automatic Crown & Bridge Remover



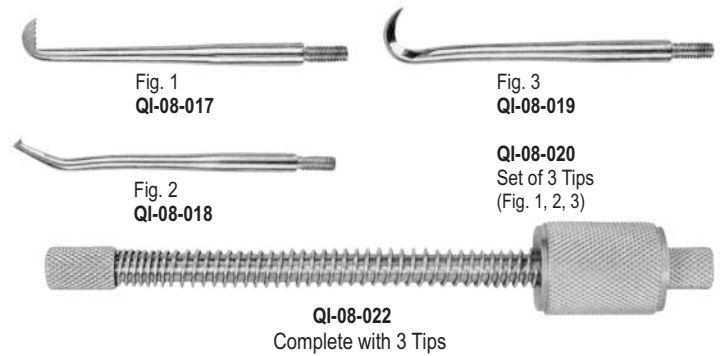
Automatic Crown & Bridge Remover



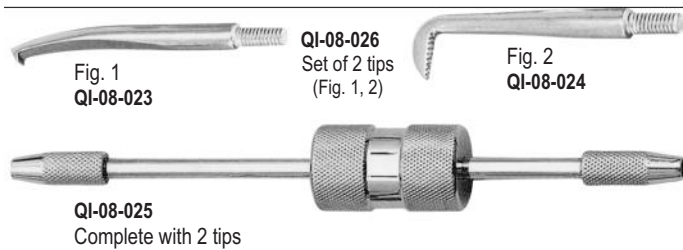
Morrel Manual Crown Remover



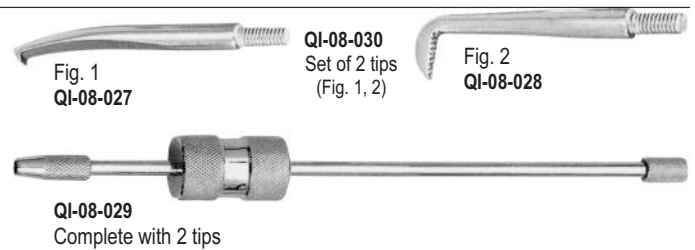
Morrel Manual Crown Remover with Spring



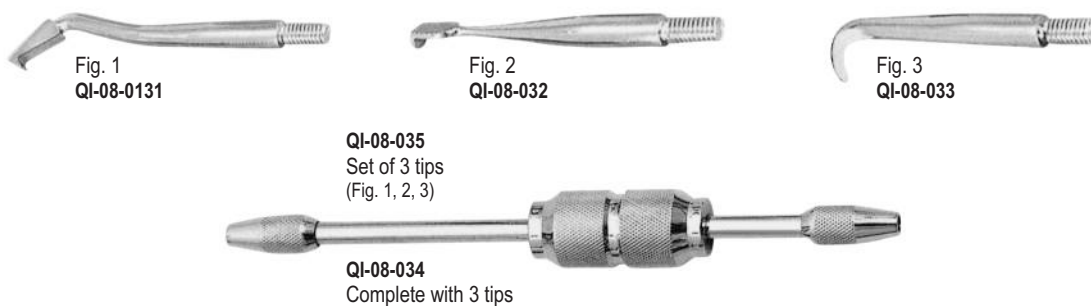
MRU manual crown remover double ended



MRU manual crown remover single ended



MRU manual crown remover double ended



**CROWN REMOVERS & CROWN SPREADERS**  
**RIMUOVERE LA CORONA E DIFFONDERE LA CORONA**

Forceps For Articulating Paper

Semi-Automatic Crown & Bridge Remover



Fig. 1  
**QI-08-036**

Fig. 3  
**QI-08-037**

Fig. 2  
**QI-08-038**

**QI-08-039**  
 Tightening Key

Set of 3 tips & Tightening Key



**QI-08-040**

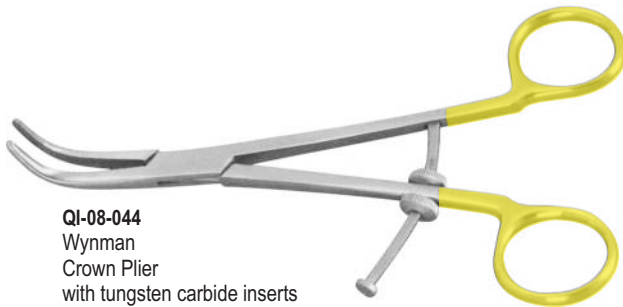
Contents: 1 Crown Remover, Tightening Key, 3 Tips



**QI-08-041**  
 Miller  
 15 cm

**QI-08-042**  
 Miller  
 15 cm

**QI-08-043**  
 J&W  
 15 cm



**QI-08-044**  
 Wynman  
 Crown Plier  
 with tungsten carbide inserts



**QI-08-045**  
 Furrer Crown Plier  
 16 cm



**QI-08-046**  
 Crown spreader



Crown Spreader



Fig. 0  
**QI-08-047**



Fig. 1  
**QI-08-048**



Fig. 2  
**QI-08-049**



Fig. 3  
**QI-08-050**  
 Crown Spreader



**QI-08-051**  
Telescope Crown Plier  
13 cm



**QI-08-052**  
Telescope Crown Plier  
Fine  
15 cm



**QI-08-053**  
Telescope Crown Plier  
Diamond coated  
13 cm



**QI-08-054**  
Telescope Crown Plier  
Diamond coated  
13 cm



**QI-08-055**  
Montfort  
18 cm



**QI-08-056**  
Bohm  
16 cm



**QI-08-057**  
Upper Crown Removing



**QI-08-058**  
Lower Crown Removing



**QI-08-059**  
Upper Crown Removing



**QI-08-060**  
Lower Crown Removing



**QI-08-061**  
 Brewer



**QI-08-062**  
 Ivory



**QI-08-063**  
 Ivory  
 Light Weight



**QI-08-064**  
 Matrix Plier  
 17 cm



**QI-08-065**  
 Stokes



**QI-08-066**  
 Stokes / Palmer



**QI-08-067**  
 Ivory

Rubber Dam Punches



Fig.1  
**QI-08-068**  
 Ainsworth



Fig.2  
**QI-08-069**  
 Ainsworth



Fig. A (14,18A)  
QI-08-070  
Molars, deciduous molars & part erupted teeth.



Fig. AW (14,18A)  
QI-08-071  
Molars with good gingival retraction.



Fig. BW (4,5,8,14)  
QI-08-072  
Molars with good gingival retraction.



Fig. C (6,9,15,212)  
QI-08-073  
Incisors, canines & bicuspid.



Fig. DW (2,7)  
QI-08-074  
Small molars & large bicuspid.



Fig. E (00,0,2,2A,9,15,18A)  
QI-08-075  
All incisors, canines & premolars with limited gingival retraction.



Fig. EW (00,0,2,2A,9,15,18A)  
QI-08-076  
All incisors, canines & premolars with limited gingival retraction.



Fig. FW (14A)  
QI-08-077  
Very stable molar clamp.



Fig. G (1,2,2A)  
QI-08-078  
Small 3rd molars, deciduous molars, bicuspid & canines.



Fig. GW (1,2,2A)  
QI-08-079  
Small 3rd molars, deciduous molars, bicuspid & canines.



Fig. HW (14W)  
QI-08-080  
Extended arch version of AW.



Fig. JW (26A)  
QI-08-081  
Large molars with deep gingival fit.



Fig. K (3,4,5,7A,8,10,11,26,7,8A)  
QI-08-082  
General winged molar clamp.



Fig. L (0)  
QI-08-083  
Large jaw version of E.



Fig. M (2)  
QI-08-084  
Winged clamp for bicuspid.



Fig. NW  
QI-08-085  
Medium size molar clamp.



Fig. PW (9UW,W5)  
QI-08-086  
Large, bland molar clamp.

Winged Premolars



Fig. 00  
QI-08-087



Fig. 0  
QI-08-088



Fig. 1  
QI-08-089



Fig. 2  
QI-08-090



Fig. 2A  
QI-08-091

Winged Anterior



Fig. 9  
QI-08-092



Fig. 212  
QI-08-093

Winged Molars



Fig. 7  
58-208-07



Fig. 8  
58-208-08



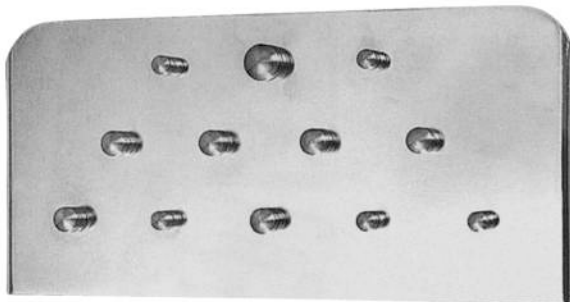
Fig. 8A  
58-208-81



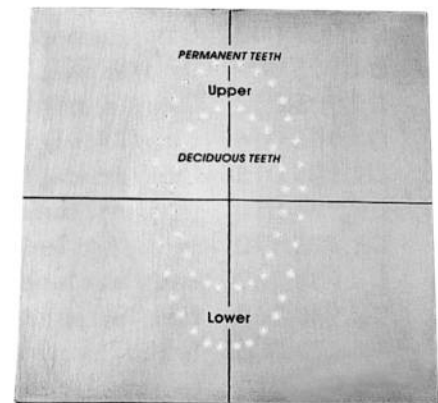
Fig. 14  
58-208-14



Fig. 14A  
58-208-14



QI-08-094  
Rubber Dam Clamps Tray



QI-08-095  
Rubber Dam Template



Matrix bands

Nystrom (Pack of 12)



Fig. 2 **QI-08-096**



Fig. 4 **QI-08-097**



Fig. 5 **QI-08-098**

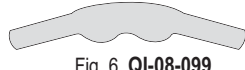


Fig. 6 **QI-08-099**

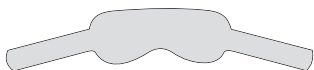


Fig. 7 **QI-08-100**

Ivory (Pack of 12)



Fig. 11 **QI-08-101**  
for children



Fig. 12 **QI-08-102**  
for children



Fig. 14 **QI-08-103**



Fig. 15 **QI-08-104**



Fig. 16 **QI-08-105**

Tofflemire (pack of 12)



Fig. 101 **QI-08-106**

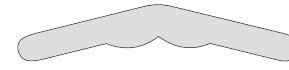


Fig. 102 **QI-08-107**

Matrix Retainers



**QI-08-108**  
with cheek protector  
5 mm



Fig. 8  
**QI-08-109**  
Ivory  
5 mm



Fig. 8  
**QI-08-110**  
Ivory  
6 mm



Fig. 8  
**QI-08-111**  
Ivory  
7 mm



**QI-08-112**  
Tofflemire Junior



**QI-08-113**  
Tofflemire Senior



**QI-08-114**  
Tofflemire universal



**QI-08-115**  
Nystrom  
Left



**QI-08-116**  
Nystrom  
Right



Fig. 12A  
**QI-08-117**  
Ivory

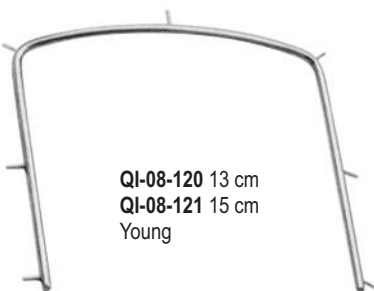


Fig. 12  
**QI-08-118**  
Ivory

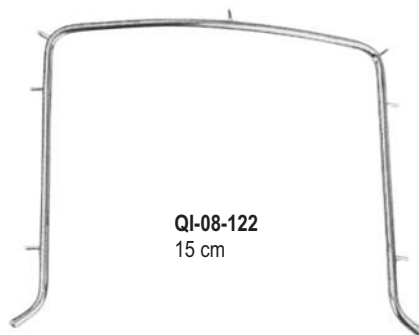


**QI-08-119**  
Strip clamp  
straight

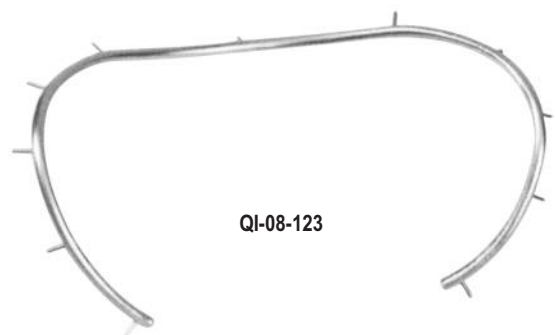
Rubber Dam Frames



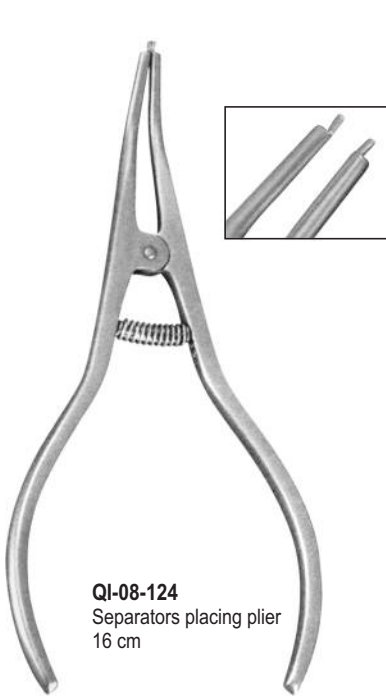
**QI-08-120** 13 cm  
**QI-08-121** 15 cm  
Young



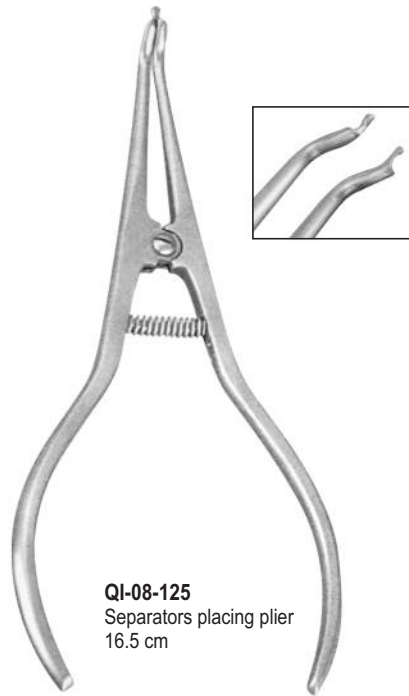
**QI-08-122**  
15 cm



**QI-08-123**



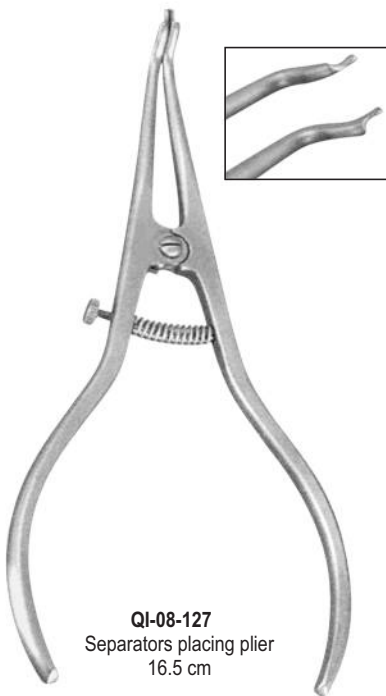
**QI-08-124**  
Separators placing plier  
16 cm



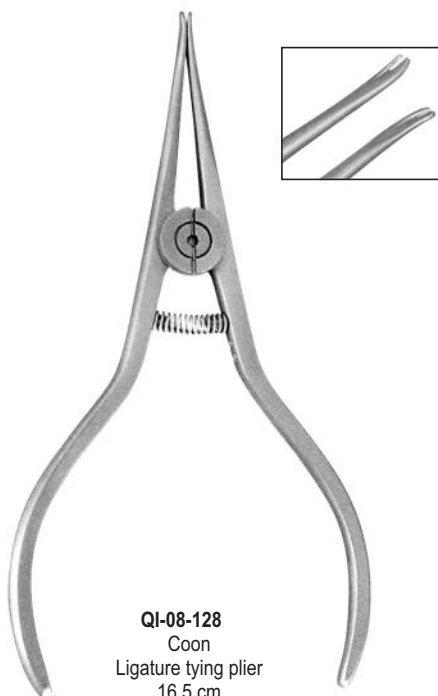
**QI-08-125**  
Separators placing plier  
16.5 cm



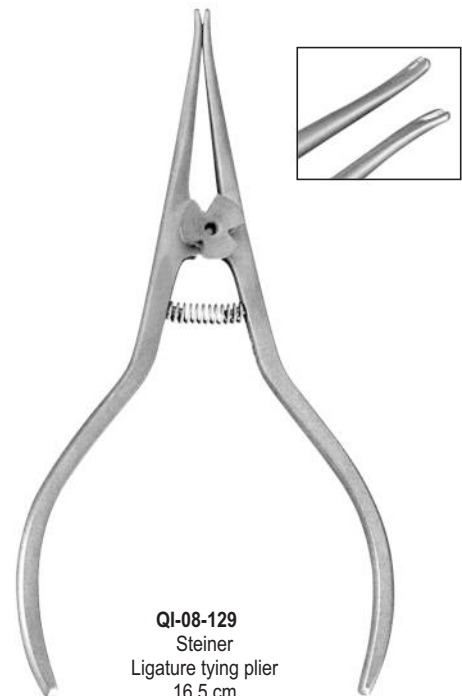
**QI-08-126**  
Separators palcing plier  
15.5 cm



**QI-08-127**  
Separators placing plier  
16.5 cm

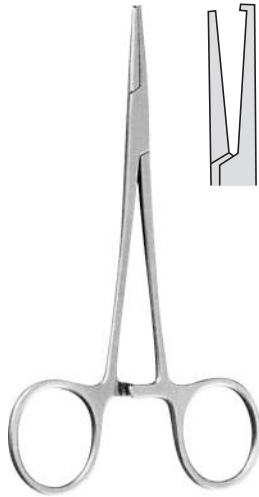


**QI-08-128**  
Coon  
Ligature tying plier  
16.5 cm

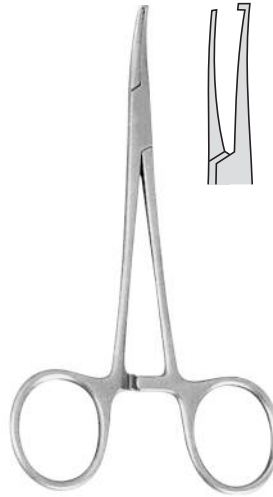


**QI-08-129**  
Steiner  
Ligature tying plier  
16.5 cm

ELASTIC LIGATURE PLACING FORCEPS  
PINZA PER POSIZIONAMENTO DI LEGATURA ELASTICA



**QI-08-130**  
Str 12 cm



**QI-08-131**  
Cvd 12 cm



**QI-08-132**  
14 cm



**QI-08-133**  
12 cm



**QI-08-134**  
14 cm



**QI-08-135**  
Elastomeric ligature  
removing tweezer



Ligature plier  
14 cm



Fig.1  
**QI-08-136**



Fig.2  
**QI-08-137**



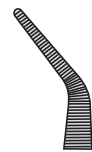
Fig.3  
**QI-08-138**



Smaha  
Ligature plier  
14 cm



**QI-08-139**  
Str



**QI-08-140**  
Cvd



**QI-08-141**  
Ligature plier  
14 cm



With tungsten  
carbide insert

Elastic Ligature Applicators

For easy placement of elastic ligatures under bracket tie wings



QI-08-142



QI-08-143

Elastomeric Ligature Removing Instruments

Multi-purpose instruments, ligature tucker & elastomeric ligature remover



QI-08-144



QI-08-145

Ligature Tuckers

Solid handle



QI-08-146



QI-08-147



QI-08-148



Disc safety guards set  
Protects patients gums, lips and cheeks from rotating discs



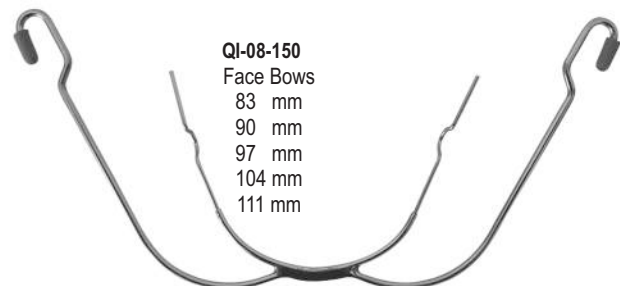
22 mm



16 mm



8 mm



QI-08-150  
Face Bows  
83 mm  
90 mm  
97 mm  
104 mm  
111 mm

Distal End Bending Instruments



**QI-08-151**  
For wire upto .22" (0.56 mm)

**QI-08-152**  
For wire upto .30" (0.76 mm)



**QI-08-153**  
For wire upto .22" (0.56 mm)

**QI-08-154**  
For wire upto .30" (0.76 mm)



Lingual Torquing Key

**QI-08-155**

NiTi Ice Instrument 11.5 cm



**QI-08-156**

Turns NiTi wire soft and flexible immediately for faster wire placement



Bracket Placer for Posterior Teeth



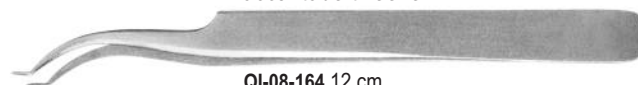
**QI-08-157**

Reverse action buccal tube tweezer



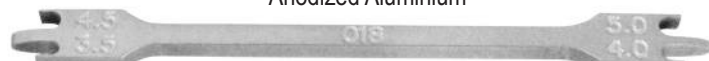
**QI-08-162** 12.5 cm  
**QI-08-163** 13.5 cm

Buccal tube tweezer



**QI-08-164** 12 cm  
**QI-08-165** 13.5 cm  
Keat

MRU Bracket Positioning Gauges  
Anodized Aluminium



**QI-08-158** For .018" slot brackets



**QI-08-159** For .022" slot brackets

Bracket Placing Tweezers



**QI-08-166** 13.5 cm



**QI-08-167** 13.5 cm



**QI-08-168** 11 cm



**QI-08-160**

Manual interdental stipper handle

Bracket Tweezers with Slot Aligner



**QI-08-169** 13.5 cm Fig. 1



**QI-08-170** 13.5 cm Fig. 2



**QI-08-171** 13.5 cm Fig. 3



**QI-08-161**  
Boone

Universal for both .018" or .022" slot brackets  
four different MRU for bracket positioning:  
3.5, 4, 4.5, & 5 mm Stainless Steel



**QI-08-172**  
Band Seater 15 cm



**QI-08-173**  
Mershon band pusher 14 cm



**QI-08-174**  
Band seating



**QI-08-175**  
Molar Band Seater  
14cm

Back view

Scaler & band pushing Instruments  
(6 mm Solid Handles)



**QI-08-176** Director/Pusher



**QI-08-177** Pusher/Scaler # 300S



**QI-08-178** Ligature Director /Scaler



**QI-08-179** Ligature Director D.E



**QI-08-180** Adhesive remover

Measuring Instruments



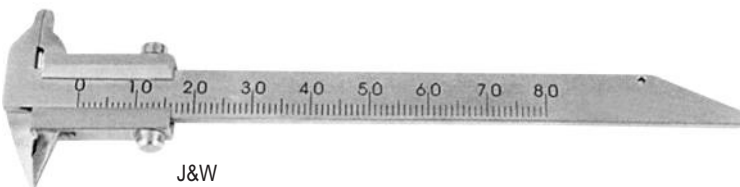
**Bernklau**  
**QI-08-181** Orthodontic ruler  
Perfect for all diagnostic measurements,  
both intraoral and on the model



**Ruler stainless steel**  
**QI-08-182** 15 cm / 6"  
**QI-08-183** 30 cm / 12"



**Beerendonk**  
**QI-08-184**  
Dental vernier with long & fine tips for intraoral measurements



**J&W**  
**QI-08-185**  
Double sided, for inner & outer measurements



Orthodontic bow compass  
**QI-08-186**

**Turrets**  
For forming archwires, without torque,  
for wires .016" to .022" (0.41mm to 0.56mm)

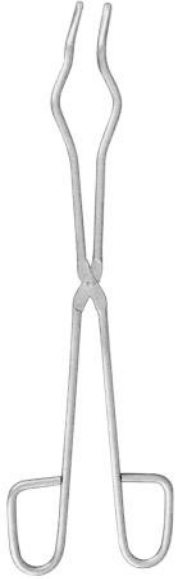


**QI-08-186**  
Made of Stainless steel



**QI-08-187**  
Made of anodized Aluminum  
Disinfectable

Furnace Tongs



**QI-08-188**  
31 cm



**QI-08-189**  
40 cm



**QI-08-190**  
56 cm



**QI-08-191** 20 cm Str  
**QI-08-192** 20 cm Cvd  
Plaster Cutter

Calipers



Fig.1  
**QI-08-193**  
Boley  
Measuring range  
0-100 mm



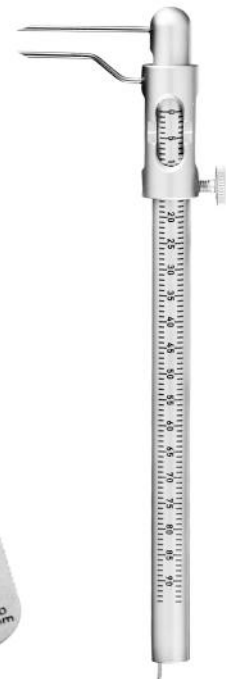
Fig.2  
**QI-08-194**  
Boley  
Measuring range  
0-100 mm



**QI-08-195**  
Iwanson for Wax  
Measuring range  
0-10 mm



**QI-08-196**  
Iwanson for Metal  
Measuring range  
0-10 mm



**QI-08-197**  
Micro Boley Gauge

Modeling saw & blades



QI-08-198



QI-08-199  
0.25 x 3 mm  
Pack of 12 pcs



QI-08-200  
0.25 x 5 mm  
Pack of 12 pcs



QI-08-201  
0.12 x 5 mm  
Pack of 12 pcs

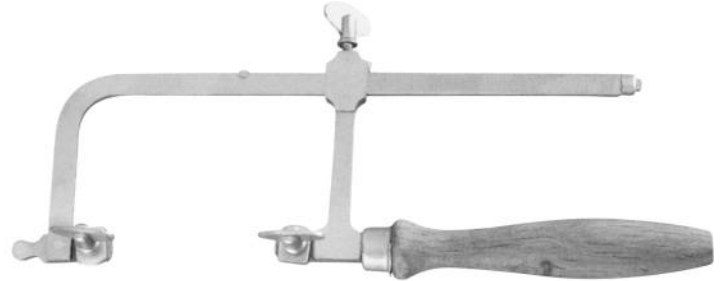


QI-08-202 Soldering Tweezer  
Str 16 cm



QI-08-203  
Soldering Tweezer  
Cvd 16 cm

Fret saw & blades



QI-08-204

QI-08-205  
Saw blades for metal  
Pack of 12 pcs

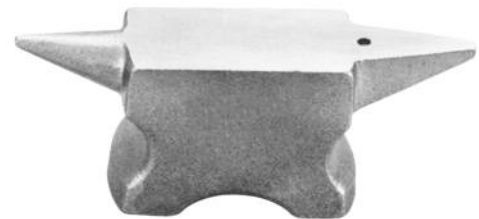
QI-08-206  
Saw blades for plaster  
Pack of 12 pcs



Fig.1  
QI-08-207  
Riveting Mallet 22 cm

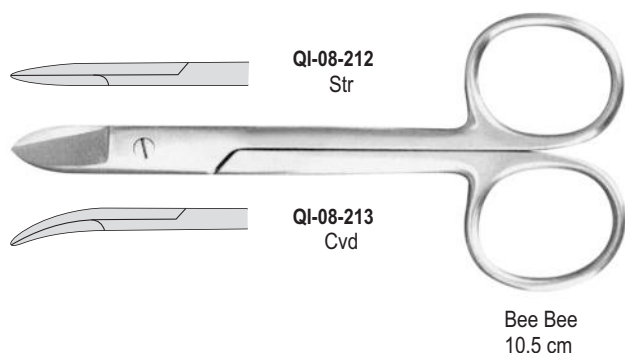
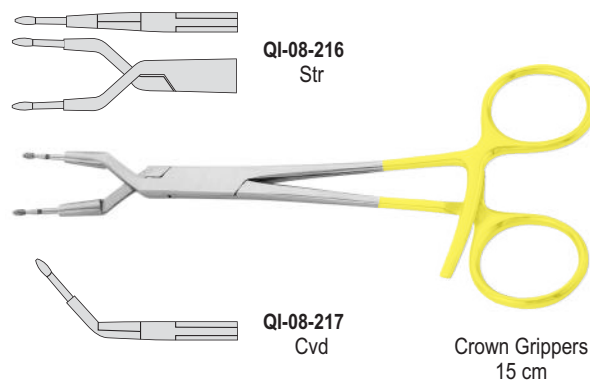
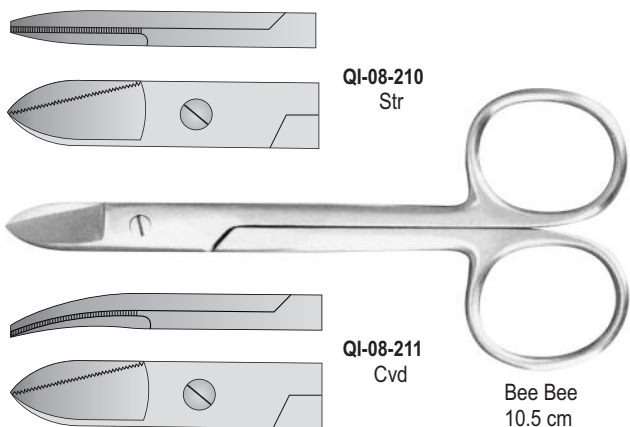


Fig.2  
QI-08-208  
Riveting Mallet 22 cm

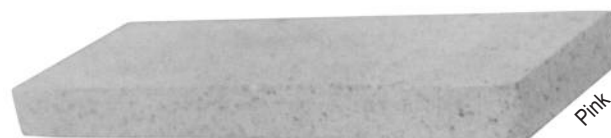


QI-08-209  
Anvil  
Carbon Steel  
L 110 x W 30 x H 40 mm





Grinding stones



**QI-08-218**  
Rectangular  
For knives, curettes, scalers etc., medium grit, pink



**QI-08-219**  
Taper round corners  
For knives, curettes, scalers etc., Fine grit, white



**QI-08-220**  
Round  
For curettes, coarse grit, green



**QI-08-221**  
Conical  
For elevators & luxators, fine grit, white

Bib chains



Fig. 1  
QI-08-222  
Ball chain



QI-08-223  
Plastic chain

Bowls for plaster & alginate



Silicone  
Green  
QI-08-224 Ø0 cm  
QI-08-225 Ø2 cm  
QI-08-226 Ø4 cm  
QI-08-227 Ø6 cm



Polyethylene  
White  
QI-08-228 Ø0 cm  
QI-08-229 Ø2 cm  
QI-08-230 Ø4 cm

X-Ray holders



Fig. 1  
QI-08-231



Fig. 6  
QI-08-232  
6 Clips



Fig. 10  
QI-08-233  
10 Clips

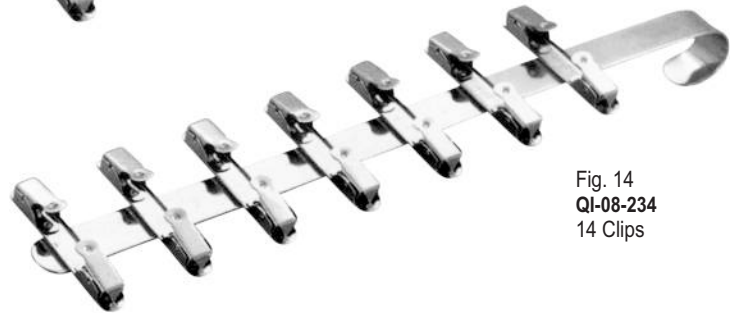


Fig. 14  
QI-08-234  
14 Clips



QI-08-235  
Bur Changer  
Square Key



QI-08-236  
Bur Changer  
Hexagonal Key



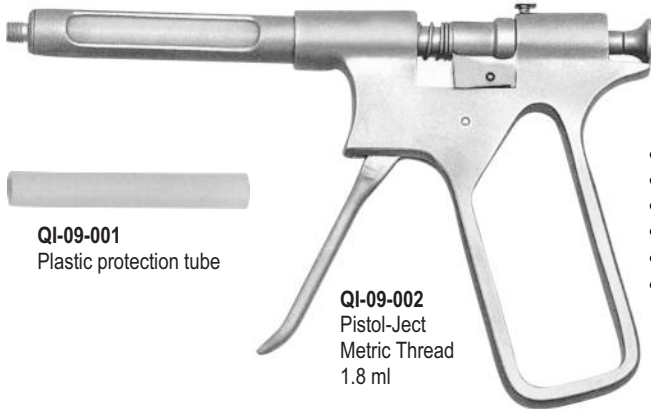
09

Page 134-138

## Dental Syringes

Intraligamental Syringes

Self & Manual Aspirating Syringes



**QI-09-001**  
Plastic protection tube

**QI-09-002**  
Pistol-Ject  
Metric Thread  
1.8 ml

- Injects 0.02 ml with every click
- Exact dosage every time
- Lever action for high injection pressure
- Suitable for use with all 1.8 ml dental cartridges
- Made of brass, Chrome plated
- Stainless steel plungers



**QI-09-003**  
Pistol-Ject  
Metric Thread  
1.8 ml

#### Disc System

##### Dual self aspiration system:

Disc system syringe has dual aspiration feature to achieve self aspiration.

##### Aspiration before injection:

Insert syringe in tissue and press Thumb disc to achieve aspiration.

##### Aspiration during injection:

Automatic aspiration occurs whenever pressure on the plunger is released.



**QI-09-004**  
Disc System  
Metric Thread  
1.8 ml

#### Projection System

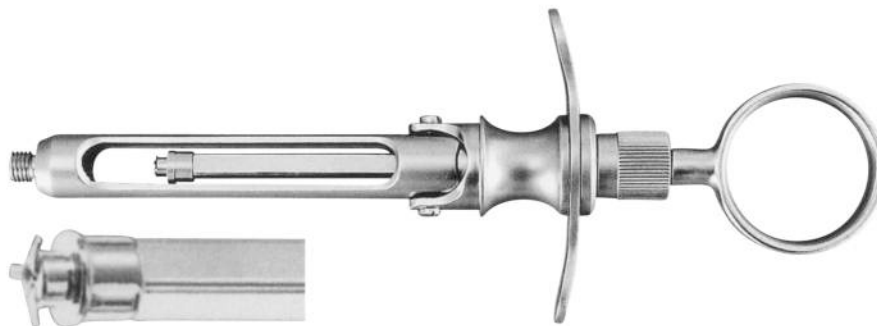
##### Aspiration during injection:

Automatic aspiration occurs whenever pressure on the plunger is released.



**QI-09-005**  
Projection System  
Metric Thread  
1.8 ml

3 movable hooks securely holds the cartridge for safe aspiration, the syringe also has self aspiration feature.



**QI-09-006**  
Trio  
Metric Thread  
1.8 ml

# INTRALIGAMENTAL SYRINGES SIRINGHE INTRALIGAMENTALI

- Made of 18-8 stainless steel
- Longer life than brass syringes
- No chipping of chrome
- Guaranteed quality
- Sterilizable by any method

- Injects 0.05 ml with every click
- Exact dosage every time
- Supplied with angled & straight tubes
- Suitable for use with all 1.8 ml dental cartridges
- Made of stainless steel

- Injects 0.06 ml with every click
- Exact dosage every time
- Suitable for use with all 1.8 ml dental cartridges
- Made of stainless Steel

- Injects 0.06 ml with every click
- Exact dosage every time
- Suitable for use with all 1.8 ml dental cartridges
- Made of stainless Steel

- Injects 0.06 ml with every click
- Exact dosage every time
- Suitable for use with all 1.8 ml dental cartridges
- Made of stainless Steel

- Fully autoclaveable
- Removeable head piece with angled threaded nozzle for the injection needle.
- Viewing chamber with safety sleeve for carpule eartridge.
- Colour coated
- Also available in original Steel colour.



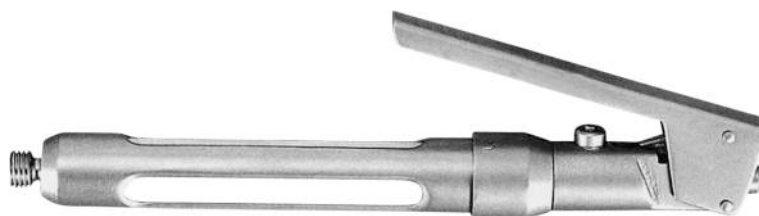
**QI-09-007**  
Metric Thread  
1.8 ml



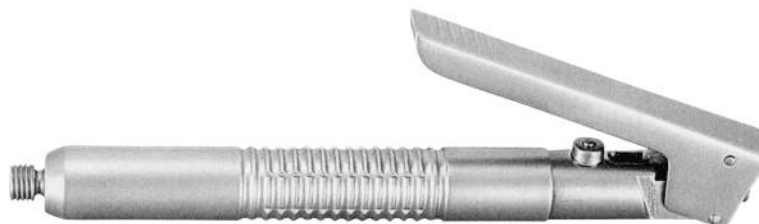
**QI-09-008**  
Angled  
Metric Thread  
1.8 ml



**QI-09-009**  
Straight  
Metric Thread  
1.8 ml



**QI-09-010**  
Swedish Type  
Metric Thread  
1.8 ml



**QI-09-011**  
Intraligamental  
Syringe  
1.8 ml





**QI-09-012**  
Type - A  
Metric Thread  
1.8 ml

Dual aspiration system  
Self and manual aspirating syringes  
During injection aspiration can be achieved either manually by retracting the plunger backward or simply releasing pressure on plunger will produce self aspiration.



**QI-09-013**  
Type - C  
Metric Thread  
1.8 ml

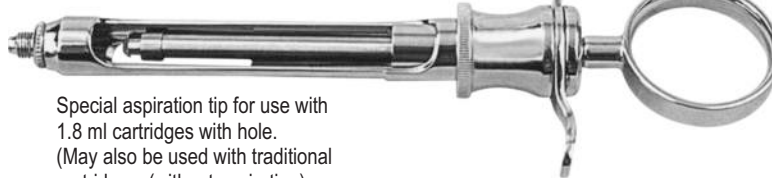
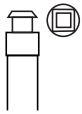
### Manual Aspirating Syringes



**QI-09-014**  
Type - A  
Metric Thread  
1.8 ml



**QI-09-015**  
Type - C  
Metric Thread  
1.8 ml



Special aspiration tip for use with 1.8 ml cartridges with hole.  
(May also be used with traditional cartridges. (without aspiration).

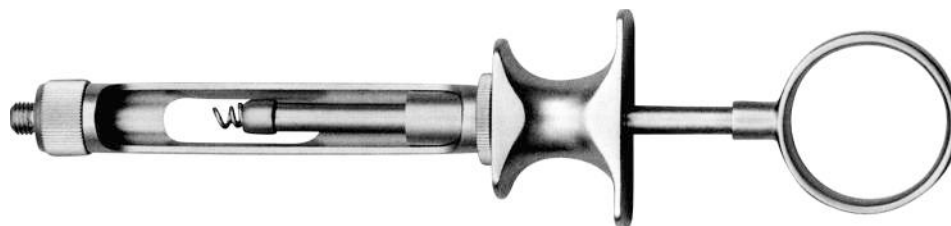
**QI-09-016**  
P - Ject  
Metric Thread  
1.8 ml



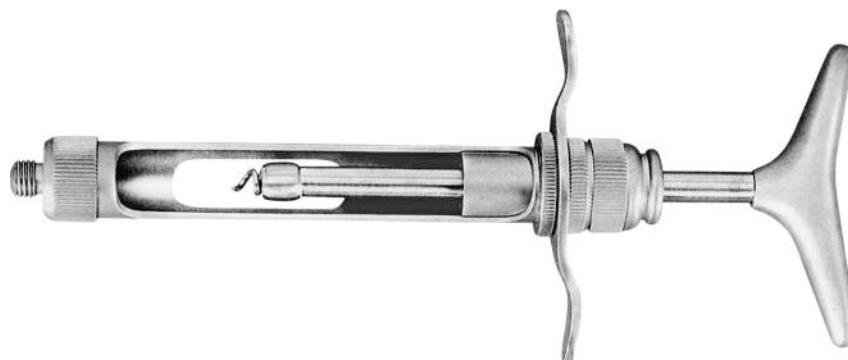
**QI-09-017**  
Type - A  
Metric Thread  
1.8 ml



**QI-09-018**  
Euro  
Metric Thread  
1.8 ml



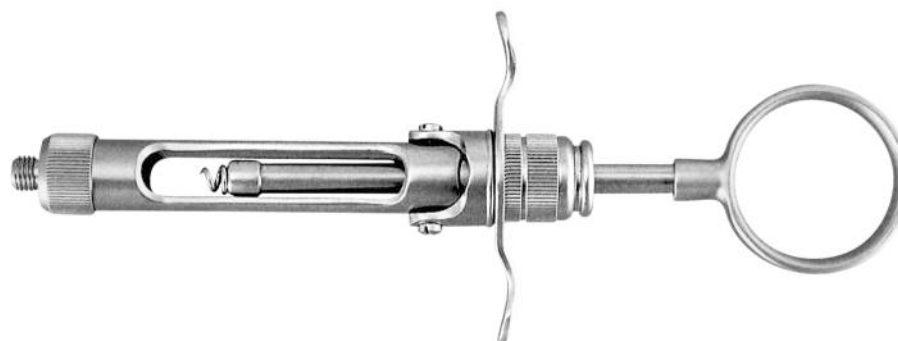
**QI-09-019**  
Euro  
Metric Thread  
1.8 ml



**QI-09-020**  
T - Handle  
Metric Thread  
1.8 ml



**QI-09-021**  
3 - Ring  
Metric Thread  
1.8 ml



**QI-09-022**  
Euro breech loading, Ring handle  
Metric Thread  
1.8 ml



**QI-09-023**  
Euro breech loading, T - handle  
Metric Thread  
1.8 ml



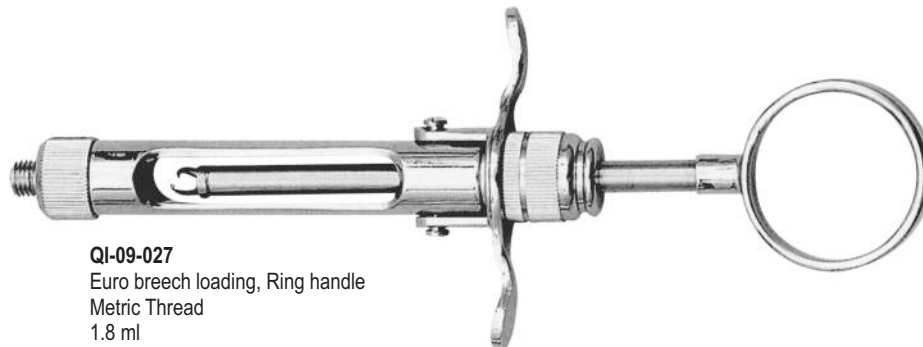
**QI-09-024**  
Euro  
Metric Thread  
1.8 ml



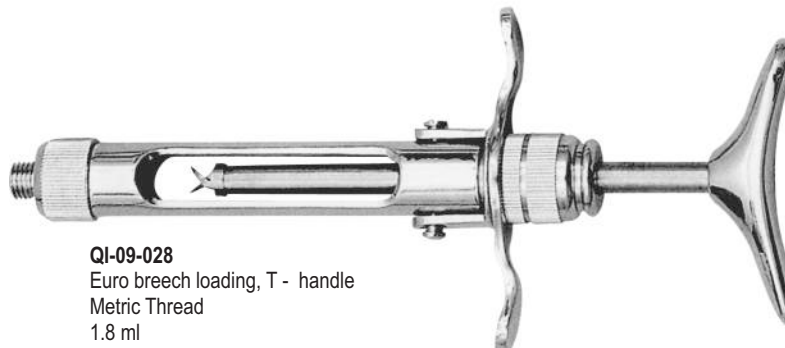
**QI-09-025**  
3 - Ring  
Metric Thread  
1.8 ml



**QI-09-026**  
2 - Ring  
Metric Thread  
1.8 ml



**QI-09-027**  
Euro breech loading, Ring handle  
Metric Thread  
1.8 ml



**QI-09-028**  
Euro breech loading, T - handle  
Metric Thread  
1.8 ml





10

Page 139-143

Impression Trays  
Impression Trays (Solid & Perforated)

Made of High Quality Non-Magnetic Stainless Steel (AISI 304). Micro Etched Inner Surface For Better Retention



**Perforated with Rim**



Fig. 30  
**QI-10-001**  
Upper Left / Lower Right

Fig. 31  
**QI-10-002**  
Lower Left / Upper Right

Fig. 32  
**QI-10-003**  
Lower Jaw

Fig. 33  
**QI-10-004**  
Upper Jaw

Fig. 99  
**QI-10-005**  
Lateral

**Solid with Rim**



Fig. 30  
**QI-10-006**  
Upper Left / Lower Right

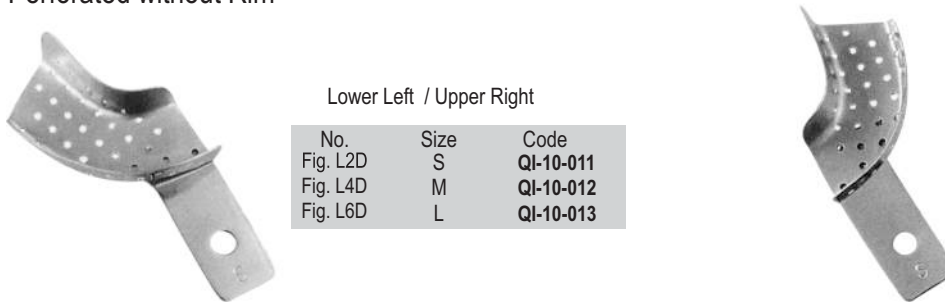
Fig. 31  
**QI-10-007**  
Lower Left / Upper Right

Fig. 32  
**QI-10-008**  
Lower Jaw

Fig. 33  
**QI-10-009**  
Upper Jaw

Fig. 99  
**QI-10-010**  
Lateral

**Perforated without Rim**



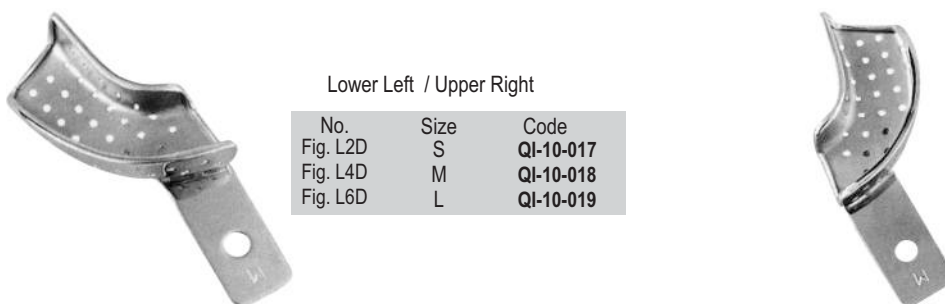
Lower Left / Upper Right

No.	Size	Code
Fig. L2D	S	<b>QI-10-011</b>
Fig. L4D	M	<b>QI-10-012</b>
Fig. L6D	L	<b>QI-10-013</b>

Upper Left / Lower Right

No.	Size	Code
Fig. L2S	S	<b>QI-10-014</b>
Fig. L4S	M	<b>QI-10-015</b>
Fig. L6S	L	<b>QI-10-016</b>

**Perforated with Rim**



Lower Left / Upper Right

No.	Size	Code
Fig. L2D	S	<b>QI-10-017</b>
Fig. L4D	M	<b>QI-10-018</b>
Fig. L6D	L	<b>QI-10-019</b>

Upper Left / Lower Right

No.	Size	Code
Fig. L2S	S	<b>QI-10-020</b>
Fig. L4S	M	<b>QI-10-021</b>
Fig. L6S	L	<b>QI-10-022</b>

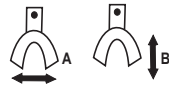
Made of High Quality Non-Magnetic Stainless Steel (AISI 304). Micro Etched Inner Surface For Better Retention

Silicone buttons for impression trays  
Fit any impression tray. Easy identification of size

Perforated without Rim



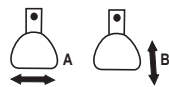
Lower



No.	Size	A mm	B mm	Code
L1	XXS	55	47	QI-10-023
L2	XS	60	49	QI-10-024
L3	S	72	54	QI-10-025
L4	M	74	57	QI-10-026
L5	L	76	59	QI-10-027
L6	XL	78	61	QI-10-028



Upper



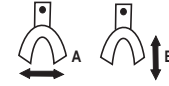
No.	Size	A mm	B mm	Code
U1	XXS	61	47	QI-10-029
U2	XS	64	51	QI-10-030
U3	S	66	53	QI-10-031
U4	M	69	57	QI-10-032
U5	L	71	60	QI-10-033
U6	XL	73	62	QI-10-034

Set	Contents	Code
6 Pcs	L3,L4,L5,U3,U4,U5	QI-10-035
8 Pcs	L3,L4,L5,L6,U3,U4,U5,U6	QI-10-036
12 Pcs	L1,L2,L3,L4,L5,L6 U1,U2,U3,U4,U5,U6	QI-10-037

Perforated with Rim



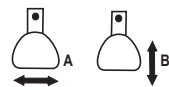
Lower



No.	Size	A mm	B mm	Code
L1	XXS	55	47	QI-10-053
L2	XS	60	49	QI-10-054
L3	S	72	54	QI-10-055
L4	M	74	57	QI-10-056
L5	L	76	59	QI-10-057
L6	XL	78	61	QI-10-058



Upper



No.	Size	A mm	B mm	Code
U1	XXS	61	47	QI-10-059
U2	XS	64	51	QI-10-060
U3	S	66	53	QI-10-061
U4	M	69	57	QI-10-062
U5	L	71	60	QI-10-063
U6	XL	73	62	QI-10-064

Set	Contents	Code
6 Pcs	L3,L4,L5,U3,U4,U5	QI-10-065
8 Pcs	L3,L4,L5,L6,U3,U4,U5,U6	QI-10-066
12 Pcs	L1,L2,L3,L4,L5,L6 U1,U2,U3,U4,U5,U6	QI-10-067

Solid without Rim



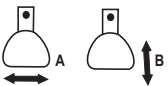
Lower



No.	Size	A mm	B mm	Code
L1	XXS	55	47	QI-10-038
L2	XS	60	49	QI-10-039
L3	S	72	54	QI-10-040
L4	M	74	57	QI-10-041
L5	L	76	59	QI-10-042
L6	XL	78	61	QI-10-043



Upper



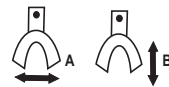
No.	Size	A mm	B mm	Code
U1	XXS	61	47	QI-10-044
U2	XS	64	51	QI-10-045
U3	S	66	53	QI-10-046
U4	M	69	57	QI-10-047
U5	L	71	60	QI-10-048
U6	XL	73	62	QI-10-049

Set	Contents	Code
6 Pcs	L3,L4,L5,U3,U4,U5	QI-10-050
8 Pcs	L3,L4,L5,L6,U3,U4,U5,U6	QI-10-051
12 Pcs	L1,L2,L3,L4,L5,L6 U1,U2,U3,U4,U5,U6	QI-10-052

Solid with Rim



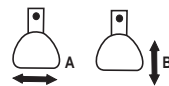
Lower



No.	Size	A mm	B mm	Code
L1	XXS	55	47	QI-10-068
L2	XS	60	49	QI-10-069
L3	S	72	54	QI-10-070
L4	M	74	57	QI-10-071
L5	L	76	59	QI-10-072
L6	XL	78	61	QI-10-073



Upper

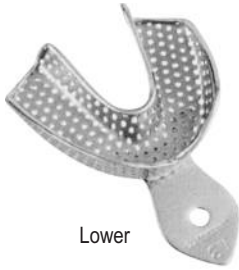


No.	Size	A mm	B mm	Code
U1	XXS	61	47	QI-10-074
U2	XS	64	51	QI-10-075
U3	S	66	53	QI-10-076
U4	M	69	57	QI-10-077
U5	L	71	60	QI-10-078
U6	XL	73	62	QI-10-079

Set	Contents	Code
6 Pcs	L3,L4,L5,U3,U4,U5	QI-10-080
8 Pcs	L3,L4,L5,L6,U3,U4,U5,U6	QI-10-081
12 Pcs	L1,L2,L3,L4,L5,L6 U1,U2,U3,U4,U5,U6	QI-10-082

Made of High Quality Non-Magnetic Stainless Steel (AISI 304).  
Micro Etched Inner Surface For Better Retention

### Perforated with Rim



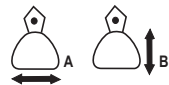
Lower



Upper



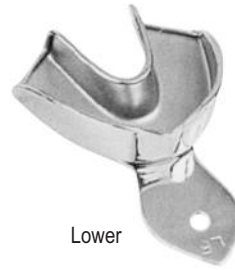
No.	Size	A mm	B mm	Code
L1	XL	80	63	QI-10-083
L2	L	78	59	QI-10-084
L3	M	76	57	QI-10-085
L4	NM	72	57	QI-10-086
L5	S	69	50	QI-10-087



No.	Size	A mm	B mm	Code
U1	XL	81	63	QI-10-088
U2	L	74	60	QI-10-089
U3	M	71	55	QI-10-090
U4	NM	67	53	QI-10-091
U5	S	65	51	QI-10-092

Set	Contents	Code
6 Pcs	L2,L3,L4,U2,U3,U4	QI-10-093
10 Pcs	L1,L2,L3,L4,L5 U1,U2,U3,U4,U5	QI-10-094

### Impression Trays Regular



Lower

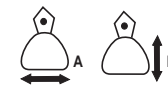


Upper

### Solid with Rim



No.	Size	A mm	B mm	Code
L1	XL	80	63	QI-10-108
L2	L	78	59	QI-10-109
L3	M	76	57	QI-10-110
L4	NM	72	57	QI-10-111
L5	S	69	50	QI-10-112



No.	Size	A mm	B mm	Code
U1	XL	81	63	QI-10-113
U2	L	74	60	QI-10-114
U3	M	71	55	QI-10-115
U4	NM	67	53	QI-10-116
U5	S	65	51	QI-10-117

Set	Contents	Code
6 Pcs	L2,L3,L4,U2,U3,U4	QI-10-118
10 Pcs	L1,L2,L3,L4,L5 U1,U2,U3,U4,U5	QI-10-119

### Impression Trays For Children

#### Perforated with Rim



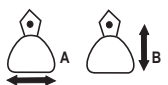
Lower



Upper



No.	Size	A mm	B mm	Code
L1	S	54	47	QI-10-095
L2	M	62	51	QI-10-096
L3	L	70	55	QI-10-097



No.	Size	A mm	B mm	Code
U1	S	55	43	QI-10-098
U2	M	60	45	QI-10-099
U3	L	63	49	QI-10-100

Set	Contents	Code
6 Pcs	L1,L2,L3,U1,U2,U3	QI-10-101

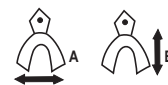


Lower

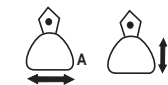


Upper

#### Solid with Rim



No.	Size	A mm	B mm	Code
L1	S	54	47	QI-10-120
L2	M	62	51	QI-10-121
L3	L	70	55	QI-10-122



No.	Size	A mm	B mm	Code
U1	S	55	43	QI-10-123
U2	M	60	45	QI-10-124
U3	L	63	49	QI-10-125

Set	Contents	Code
6 Pcs	L1,L2,L3,U1,U2,U3	QI-10-126

### Impression Trays Regular Ehrlicke Pattern Perforated



Lower

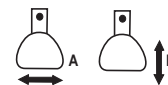


No.	Size	A mm	B mm	Code
Ub0	XS	65	46	QI-10-102
UB1	S	67	50	QI-10-103
UB2	M	76	54	QI-10-104
UB3	L	79	56	QI-10-105
UB4	XL	79	61	QI-10-106

Set	Contents	Code
10 Pcs	UB0,UB1,UB2,UB3,UB4, OB0,OB1,OB2,OB3,OB4	QI-10-107



Upper



No.	Size	A mm	B mm	Code
OB0	XS	59	52	QI-10-127
OB1	S	66	52	QI-10-128
OB2	M	71	62	QI-10-129
OB3	L	71	64	QI-10-130
OB4	XL	80	70	QI-10-131

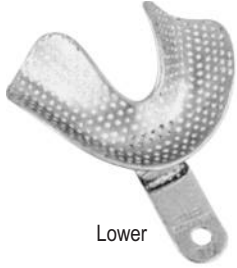
Set	Contents	Code
10 Pcs	UB0,UB1,UB2,UB3,UB4, OB0,OB1,OB2,OB3,OB4	QI-10-132

Made of High Quality Non-Magnetic Stainless Steel (AISI 304).  
Micro Etched Inner Surface For Better Retention

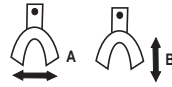
Perforated with Rim

Impression Trays Edentulous

Solid with Rim



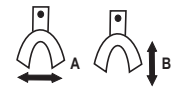
Lower



No.	Size	A mm	B mm	Code
L1	XL	84	65	QI-10-133
L2	L	77	64	QI-10-134
L3	M	76	60	QI-10-135
L4	S	68	57	QI-10-136



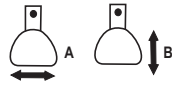
Lower



No.	Size	A mm	B mm	Code
L1	XL	84	65	QI-10-152
L2	L	77	64	QI-10-153
L3	M	76	60	QI-10-154
L4	S	68	57	QI-10-155



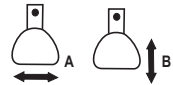
Upper



No.	Size	A mm	B mm	Code
U1	XL	80	62	QI-10-137
U2	L	77	60	QI-10-138
U3	M	70	60	QI-10-139
U4	S	72	56	QI-10-140



Upper



No.	Size	A mm	B mm	Code
U1	XL	80	62	QI-10-156
U2	L	77	60	QI-10-157
U3	M	70	60	QI-10-158
U4	S	72	56	QI-10-159

Set	Contents	Code
8 Pcs	L1,L2,L3,L4,U1,U2,U3,U4	QI-10-141

Set	Contents	Code
8 Pcs	L1,L2,L3,L4,U1,U2,U3,U4	QI-10-160

Perforated with Rim

Impression Trays Anterior Depressed

Solid with Rim



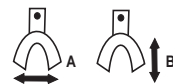
Lower



No.	Size	A mm	B mm	Code
L1	S	65	48	QI-10-142
L2	M	72	57	QI-10-143
L3	L	75	57	QI-10-144



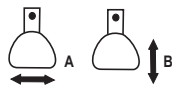
Lower



No.	Size	A mm	B mm	Code
L1	S	65	48	QI-10-161
L2	M	72	57	QI-10-162
L3	L	75	57	QI-10-163



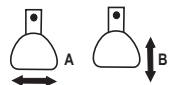
Upper



No.	Size	A mm	B mm	Code
U1	S	64	56	QI-10-145
U2	M	67	60	QI-10-146
U3	L	72	63	QI-10-147



Upper



No.	Size	A mm	B mm	Code
U1	S	64	56	QI-10-164
U2	M	67	60	QI-10-165
U3	L	72	63	QI-10-166

Set	Contents	Code
6 Pcs	L1,L2,L3,U1,U2,U3	QI-10-148

Set	Contents	Code
6 Pcs	L1,L2,L3,U1,U2,U3	QI-10-167

Impression Trays Edentulous Ehrlicke Pattern Perforated



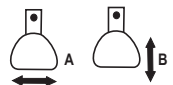
Lower



No.	Size	A mm	B mm	Code
UU1	S	70	48	QI-10-149
UU2	M	70	53	QI-10-150
UU3	L	72	57	QI-10-151



Upper



No.	Size	A mm	B mm	Code
OU1	S	64	46	QI-10-168
OU2	M	68	53	QI-10-169
OU3	L	79	61	QI-10-170

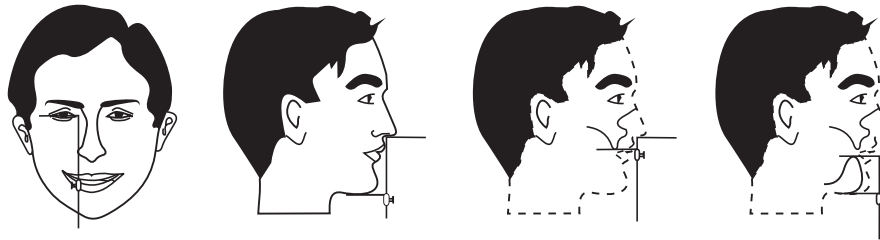
Set	Contents	Code
6 Pcs	UU1,UU2,UU3,OU1,OU2,OU3	QI-10-171

Bite Gauge

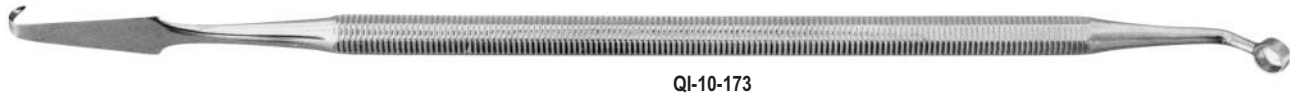
A simple measuring instrument as an aid in the re-establishment of correct facial contour during full or partial denture work.



Slide B is fully adjustable and reversible along shaft A and may be fixed at any position by means of its locking-screw as shown.



Carvers for silicone impression materials



QI-10-173

Hollow handle



QI-10-174

Gingival cord packers



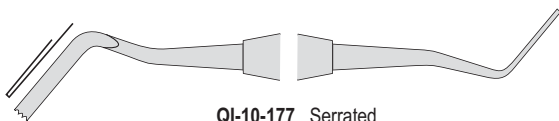
QI-10-175

Serrated

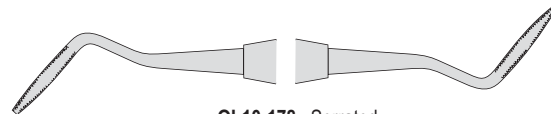


QI-10-176

Smooth



QI-10-177 Serrated



QI-10-178 Serrated

## Crown Removers

Crown Removers & Forceps for Articulating Paper  
Crown Spreaders  
Rubber Dam Instruments  
Matrix Retainers & Rubber Dam Frames  
Ligature & Separators Placing Pliers  
Elastic Ligature Placing Forceps  
Elastic Applicators & Ligature Tuckers  
Bracket Positioning Instruments  
Bracket & Measuring Instruments  
Laboratory Instruments  
Crown Instruments & Grinding Stones  
X - Ray Holders & Laboratory Bowls



Instruments Trays

QI-11-001	210 x 160 x 10 mm
QI-11-002	240 x 180 x 10 mm
QI-11-003	310 x 150 x 10 mm
QI-11-004	310 x 210 x 10 mm
QI-11-005	350 x 240 x 10 mm
QI-11-006	400 x 270 x 10 mm
QI-11-007	420 x 280 x 10 mm



Mayo Trays Perforated

QI-11-008	150 x 100 x 50 mm
QI-11-009	200 x 100 x 50 mm
QI-11-010	220 x 120 x 50 mm
QI-11-011	240 x 140 x 50 mm
QI-11-012	200 x 150 x 50 mm
QI-11-013	250 x 200 x 50 mm
QI-11-014	300 x 200 x 50 mm
QI-11-015	300 x 250 x 50 mm
QI-11-016	350 x 250 x 50 mm
QI-11-017	400 x 300 x 50 mm
QI-11-018	450 x 300 x 50 mm
QI-11-019	450 x 350 x 50 mm



DIN Baskets perforated sides

QI-11-020	240 x 240 x 50 mm
QI-11-021	240 x 240 x 100 mm
QI-11-022	480 x 260 x 50 mm
QI-11-023	520 x 260 x 80 mm
QI-11-024	520 x 260 x 100 mm



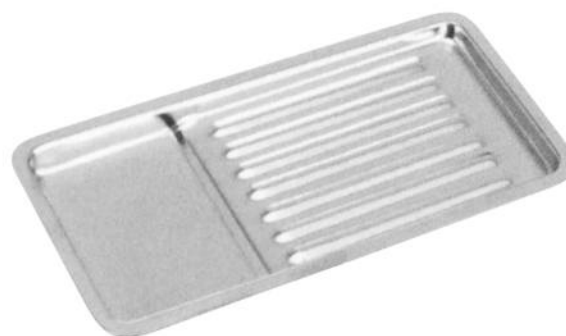
Wiremesh Baskets perforated

QI-11-025	240 x 240 x 50 mm
QI-11-026	260 x 240 x 100 mm
QI-11-027	480 x 260 x 50 mm
QI-11-028	520 x 260 x 80 mm
QI-11-029	520 x 260 x 100 mm





Scalers Trays	
QI-11-030	190 x 100 x 17 mm
QI-11-031	200 x 100 x 25 mm



Scalers Trays	
QI-11-032	185 x 80 x 15 mm



QI-11-041

Instruments Trays With LID	
QI-11-033	150 x 100 x 50 mm
QI-11-034	200 x 100 x 50 mm
QI-11-035	220 x 120 x 50 mm
QI-11-036	240 x 140 x 50 mm
QI-11-037	200 x 150 x 50 mm
QI-11-038	250 x 200 x 50 mm
QI-11-039	300 x 250 x 50 mm
QI-11-040	300 x 200 x 50 mm
QI-11-041	350 x 250 x 50 mm
QI-11-042	400 x 300 x 50 mm
QI-11-043	450 x 300 x 50 mm
QI-11-044	450 x 350 x 50 mm



Instruments Trays Without LID	
QI-11-045	150 x 100 x 50 mm
QI-11-046	200 x 100 x 50 mm
QI-11-047	220 x 120 x 50 mm
QI-11-048	240 x 140 x 50 mm
QI-11-049	200 x 150 x 50 mm
QI-11-050	250 x 200 x 50 mm
QI-11-051	300 x 250 x 50 mm
QI-11-052	300 x 200 x 50 mm
QI-11-053	350 x 250 x 50 mm
QI-11-054	400 x 300 x 50 mm
QI-11-055	450 x 300 x 50 mm
QI-11-056	450 x 350 x 50 mm



Instrument Boxes With Side Handle

QI-11-057	150 x 100 x 50 mm
QI-11-058	200 x 100 x 50 mm
QI-11-059	220 x 120 x 50 mm
QI-11-060	240 x 140 x 50 mm
QI-11-061	200 x 150 x 50 mm
QI-11-062	250 x 200 x 50 mm
QI-11-063	300 x 200 x 50 mm
QI-11-064	300 x 250 x 50 mm
QI-11-065	400 x 300 x 50 mm
QI-11-066	450 x 300 x 50 mm
QI-11-067	450 x 350 x 50 mm



Instrument Boxes With LID

QI-11-068	150 x 100 x 50 mm
QI-11-069	200 x 100 x 50 mm
QI-11-070	220 x 120 x 50 mm
QI-11-071	240 x 140 x 50 mm
QI-11-072	200 x 150 x 50 mm
QI-11-073	250 x 200 x 50 mm
QI-11-074	300 x 200 x 50 mm
QI-11-075	300 x 250 x 50 mm
QI-11-076	400 x 300 x 50 mm
QI-11-077	400 x 300 x 50 mm
QI-11-078	450 x 350 x 50 mm



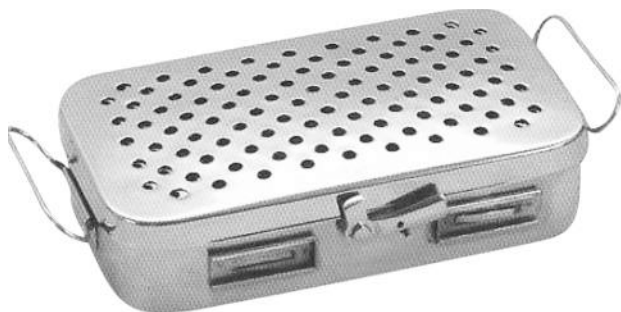
Perforated Instruments Boxes

QI-11-079	170 x 070 x 35 mm
QI-11-080	180 x 080 x 40 mm
QI-11-081	200 x 100 x 40 mm
QI-11-082	200 x 100 x 50 mm
QI-11-083	200 x 100 x 60 mm
QI-11-084	220 x 120 x 60 mm
QI-11-085	250 x 120 x 60 mm
QI-11-086	300 x 150 x 60 mm
QI-11-087	300 x 200 x 80 mm
QI-11-088	400 x 160 x 80 mm
QI-11-089	400 x 200 x 100 mm
QI-11-090	500 x 200 x 120 mm



Perforated Instruments Boxes

QI-11-091	170 x 070 x 35 mm
QI-11-092	180 x 080 x 40 mm
QI-11-093	200 x 100 x 40 mm
QI-11-094	200 x 100 x 50 mm
QI-11-095	200 x 100 x 60 mm
QI-11-096	220 x 120 x 60 mm
QI-11-097	250 x 120 x 60 mm
QI-11-098	300 x 150 x 60 mm
QI-11-099	300 x 200 x 80 mm
QI-11-100	400 x 160 x 80 mm
QI-11-101	400 x 200 x 100 mm
QI-11-102	500 x 200 x 120 mm



Instruments Boxes Perforated

QI-11-103	180 x 80 x 30 mm
QI-11-104	180 x 80 x 40 mm
QI-11-105	180 x 80 x 50 mm
QI-11-106	200 x 90 x 30 mm
QI-11-107	200 x 90 x 40 mm
QI-11-108	200 x 90 x 50 mm
QI-11-109	250 x 100 x 40 mm
QI-11-110	250 x 100 x 50 mm
QI-11-111	250 x 100 x 60 mm



Catheter trays with cover

QI-11-112	100 x 200 x 50 mm
QI-11-113	100 x 300 x 50 mm
QI-11-114	120 x 220 x 50 mm



Instruments Boxes With Filters

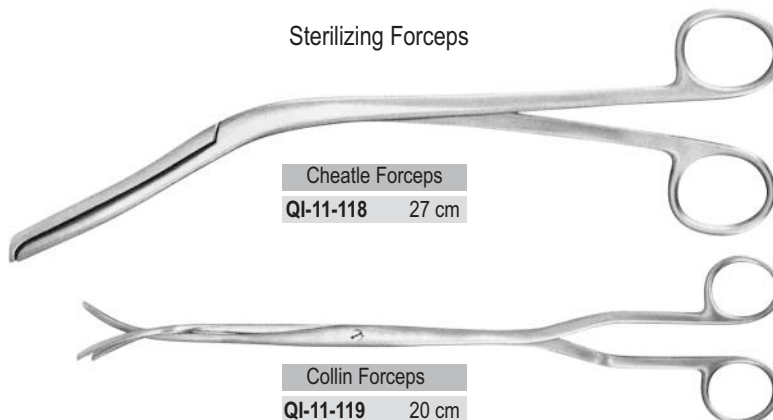
QI-11-115	170 x 070 x 35 mm
QI-11-116	180 x 080 x 40 mm
QI-11-117	200 x 100 x 40 mm
QI-11-118	200 x 100 x 50 mm
QI-11-119	200 x 100 x 60 mm
QI-11-110	220 x 120 x 60 mm
QI-11-111	250 x 120 x 60 mm
QI-11-112	300 x 150 x 60 mm
QI-11-113	300 x 200 x 80 mm
QI-11-114	400 x 160 x 80 mm
QI-11-115	400 x 200 x 100 mm
QI-11-116	500 x 200 x 120 mm



Thermometer Jar

	dia. height
QI-11-117	Ø 25 x 100 mm

Sterilizing Forceps

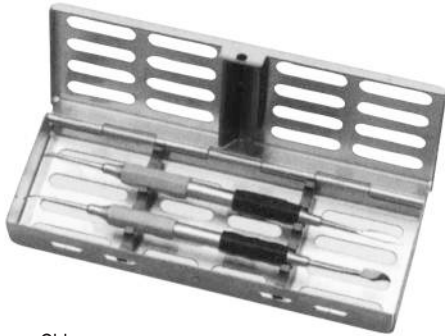


Cheattle Forceps

QI-11-118	27 cm
-----------	-------

Collin Forceps

QI-11-119	20 cm
QI-11-120	30 cm



Chico

Stainless Steel for 5 instruments

**QI-11-121** 180 x 60 x 22 mm



Medio

Stainless Steel for 10 instruments

**QI-11-122** 180 x 125 x 22 mm



Maxi

Stainless Steel for 20 instruments

**QI-11-123** 280 x 180 x 25 mm



Maxi Set 1

Stainless Steel rack for 15 instruments

**QI-11-124** 288 x 187 x 40 mm



Maxi Set 2

Stainless Steel for 15 instruments

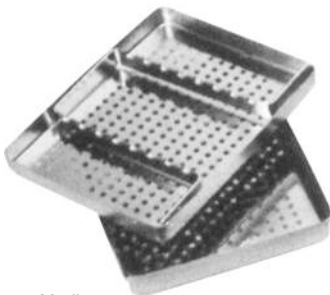
**QI-11-125** 288 x 187 x 40 mm



Maxi Set 3

Stainless Steel for 15 instruments

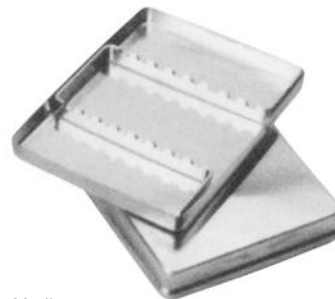
**QI-11-126** 288 x 187 x 40 mm



Medio

Stainless Steel Perforated Tray with cover

**QI-11-127** 187 x 145 x 25 mm



Medio

Stainless Steel Solid Tray with cover

**QI-11-128** 187 x 145 x 25 mm



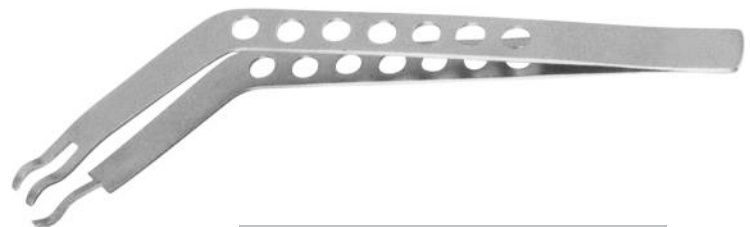
Burs Disinfecting Box Stainless Steel

**QI-11-129** 90 mm x 40 mm



Mesh Burs Holder

**QI-11-130** 35 mm x 150 mm

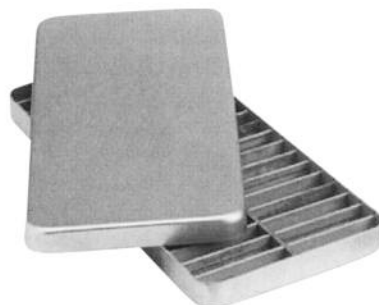


**QI-11-131** Bur Holding Tweezer 16.5 cm



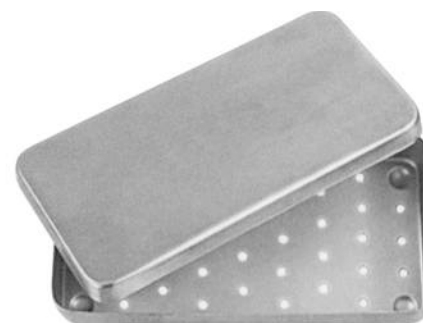
Perforated Instruments Boxes

QI-11-132	170 x 070 x 35 mm
QI-11-133	180 x 080 x 40 mm
QI-11-134	200 x 100 x 40 mm
QI-11-135	200 x 100 x 50 mm
QI-11-136	200 x 100 x 60 mm
QI-11-137	220 x 120 x 60 mm
QI-11-138	250 x 120 x 60 mm
QI-11-139	300 x 150 x 60 mm
QI-11-140	300 x 200 x 80 mm
QI-11-141	400 x 160 x 80 mm
QI-11-142	400 x 200 x 100 mm
QI-11-143	500 x 200 x 120 mm



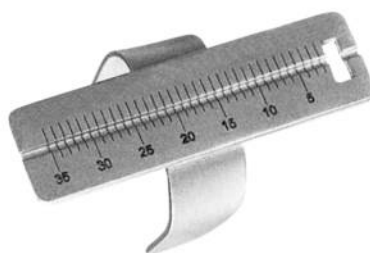
Stainless Steel endodontic tray with cover

QI-11-144 250 x 115 x 15 mm



Instrument Box perforated

QI-11-145 180 x 90 x 30 mm



QI-11-146 Endometer Laser etched



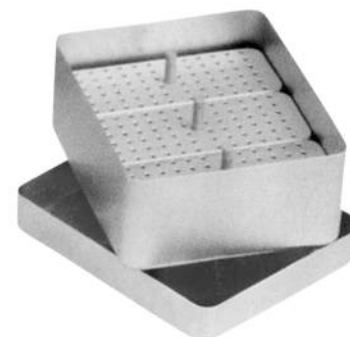
QI-11-147 Lester Pumice Cup



QI-11-148 Endo Box Round



QI-11-149 Endo Box



QI-11-150 Endo Box Trio



QI-11-151 Cotton Holder with Lid



QI-11-152 Cotton Holder without Lid



QI-11-153 Cotton Holder Estrella without Lid



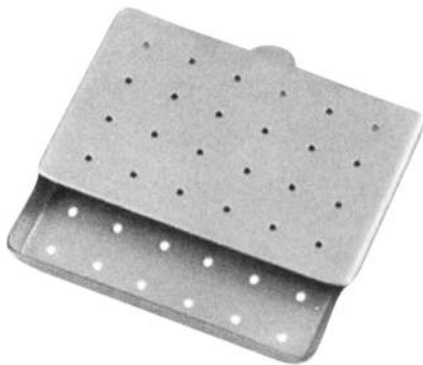
Needle Case	
<b>QI-11-154</b>	210 x 125 x 17 mm



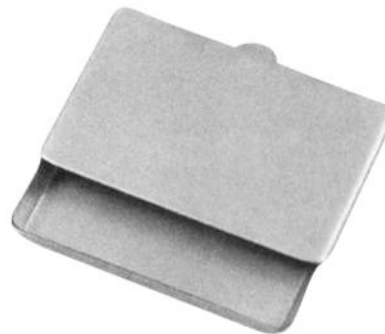
Needle Case Sauerbruch	
<b>QI-11-155</b>	210 x 125 x 17 mm



Needle Case	
<b>QI-11-156</b>	150 x 90 x 10 mm



Needle Cases Perforated	
<b>QI-11-157</b>	50 x 25 x 4.5 mm
<b>QI-11-158</b>	65 x 42 x 8 mm
<b>QI-11-159</b>	75 x 25 x 4.5 mm



Needle Cases Plain	
<b>QI-11-160</b>	50 x 25 x 4.5 mm
<b>QI-11-161</b>	65 x 42 x 8 mm
<b>QI-11-162</b>	75 x 25 x 4.5 mm



Needle Case Complete	
<b>QI-11-163</b>	



Funnels	
	dia.
<b>QI-11-164</b>	100 mm
<b>QI-11-165</b>	120 mm
<b>QI-11-166</b>	150 mm
<b>QI-11-167</b>	200 mm
<b>QI-11-168</b>	240 mm



Petri Dishes	
	dia. height
<b>QI-11-169</b>	60 x 20 mm
<b>QI-11-170</b>	90 x 15 mm
<b>QI-11-171</b>	100 x 20 mm
<b>QI-11-172</b>	120 x 20 mm



Gallipot	
	vol.
QI-11-173	50 ml
QI-11-174	100 ml
QI-11-175	150 ml
QI-11-176	225 ml



Stainless Steel Round Bowls			
	dia.	height	vol.
QI-11-177	Ø 40 mm	x 19 mm	0.05L
QI-11-178	Ø 60 mm	x 30 mm	0.07L
QI-11-179	Ø 80 mm	x 40 mm	0.14L
QI-11-180	Ø 100 mm	x 50 mm	0.35L
QI-11-181	Ø 120 mm	x 60 mm	0.45L
QI-11-182	Ø 150 mm	x 70 mm	0.70L
QI-11-183	Ø 180 mm	x 90 mm	1.10L
QI-11-184	Ø 200 mm	x 100 mm	1.60L



Stainless Steel Bowls			
	dia.	height	vol.
QI-11-185	Ø 40 mm	x 19 mm	0.05L
QI-11-186	Ø 60 mm	x 30 mm	0.07L
QI-11-187	Ø 80 mm	x 40 mm	0.14L
QI-11-188	Ø 100 mm	x 50 mm	0.35L
QI-11-189	Ø 120 mm	x 60 mm	0.45L
QI-11-190	Ø 150 mm	x 70 mm	0.70L
QI-11-191	Ø 180 mm	x 90 mm	1.10L
QI-11-192	Ø 200 mm	x 100 mm	1.60L



Wash Basins	
	dia.
QI-11-193	300 mm
QI-11-194	320 mm
QI-11-195	350 mm
QI-11-196	400 mm



Medicine Cup		
	dia.	height
QI-11-197	80 x 35 mm	
QI-11-198	125 x 60 mm	



Medicine Cup (Graduated)		
	Size ( mm )	Cap.( ml )
QI-11-199	2 Oz.	60 ml



Kidney Trays With LID	
	dia.
QI-11-200	150 mm
QI-11-201	200 mm
QI-11-202	250 mm
QI-11-203	300 mm



Kidney Trays	
	dia.
QI-11-204	150 mm
QI-11-205	200 mm
QI-11-206	250 mm
QI-11-207	300 mm



Kidney Trays Shallow	
	dia.
QI-11-208	150 mm
QI-11-209	200 mm
QI-11-210	250 mm
QI-11-211	300 mm



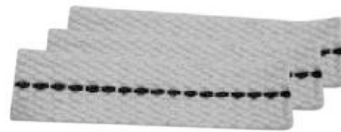
**QI-11-212** Spirit Lamp 120 cc



**QI-11-213** Spirit Lamp 120 cc



**QI-11-214** Spirit Lamp 120 cc



**QI-11-215** Spare wicks Flat 13 cm (pack of 5)



**QI-11-216** Spare wicks Round 13cm (pack of 5)



Forceps Jars

	dia.	height
<b>QI-11-217</b>	30	90 mm
<b>QI-11-218</b>	50	100 mm
<b>QI-11-219</b>	50	130 mm
<b>QI-11-220</b>	50	175 mm
<b>QI-11-221</b>	75	100 mm
<b>QI-11-222</b>	75	130 mm
<b>QI-11-223</b>	75	175 mm
<b>QI-11-224</b>	100	175 mm
<b>QI-11-225</b>	100	200 mm



Dressing Jars With Lid & Knob

	dia.	height
<b>QI-11-226</b>	75	60 mm
<b>QI-11-227</b>	75	75 mm
<b>QI-11-228</b>	100	60 mm
<b>QI-11-229</b>	100	100 mm
<b>QI-11-230</b>	125	80 mm
<b>QI-11-231</b>	125	125 mm
<b>QI-11-232</b>	150	150 mm



Dressing Jars / Cotton Containers

<b>QI-11-233</b>	80 x 60	mm
<b>QI-11-234</b>	80 x 80	mm
<b>QI-11-235</b>	100 x 60	mm
<b>QI-11-236</b>	100 x 80	mm
<b>QI-11-237</b>	100 x 100	mm
<b>QI-11-238</b>	120 x 80	mm
<b>QI-11-239</b>	120 x 100	mm
<b>QI-11-240</b>	120 x 120	mm
<b>QI-11-241</b>	150 x 100	mm
<b>QI-11-242</b>	150 x 150	mm
<b>QI-11-243</b>	180 x 150	mm
<b>QI-11-244</b>	180 x 180	mm
<b>QI-11-245</b>	200 x 200	mm
<b>QI-11-246</b>	240 x 240	mm





Irrigators	
	vol.
QI-11-247	1.0L
QI-11-248	1.5L
QI-11-249	2.0L



Measuring Jugs	
	vol.
QI-11-250	250 ml
QI-11-251	500 ml
QI-11-252	1000 ml
QI-11-253	2000 ml



Measuring Jugs	
	vol.
QI-11-254	250 ml
QI-11-255	500 ml
QI-11-256	1000 ml
QI-11-257	2000 ml



Buckets With LID		Buckets Without LID	
	vol.		vol.
QI-11-258	8.0L	QI-11-261	8.0L
QI-11-259	10.0L	QI-11-262	10.0L
QI-11-260	15.0L	QI-11-263	15.0L



Sputum Cup	
	dia. height
QI-11-264	Ø 75 x 80 mm
QI-11-265	Ø 100 x 50 mm
QI-11-266	Ø 100 x 80 mm



Ointment Jar		
	dia. height	Vol.
QI-11-267	Ø 75 x 65 mm	250ml



Urinal Jugs		
QI-11-268	Horizontal	115 x 230 mm
QI-11-269	Vertical Junior	95 x 205 mm
QI-11-270	Vertical Adult	100 x 225 mm



QI-11-271 Male Urinal



QI-11-272 Urinal Female 1200 ml



Bed Pan	
	dia.
QI-11-273	235 mm
QI-11-274	320 mm



Bed Pan	
	dia.
QI-11-275	235 mm
QI-11-276	320 mm



QI-11-277 Bed Pan



QI-11-278 American Pattern Bed Pan Adult



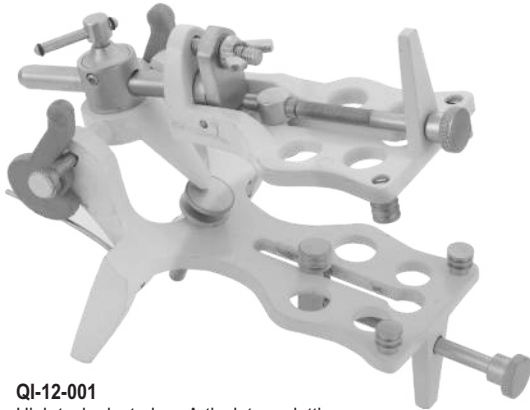
Sterilizing Drums		
	dia.	height
QI-11-279	Ø 80	x 80 mm
QI-11-280	Ø 105	x 120 mm
QI-11-281	Ø 140	x 140 mm
QI-11-282	Ø 160	x 120 mm
QI-11-283	Ø 160	x 150 mm
QI-11-284	Ø 190	x 150 mm
QI-11-285	Ø 190	x 190 mm
QI-11-286	Ø 240	x 160 mm
QI-11-287	Ø 240	x 240 mm
QI-11-288	Ø 290	x 160 mm
QI-11-289	Ø 290	x 240 mm
QI-11-290	Ø 340	x 160 mm
QI-11-291	Ø 340	x 340 mm
QI-11-292	Ø 390	x 190 mm
QI-11-293	Ø 380	x 290 mm



12

Page 155-157

Articulators

**QI-12-001**

High tech plasterless Articulator galetti with adjustable screws at rears & front. All anatomical Movements Possible Also available in vibratory polished

**QI-12-002**

Pro Tamahachi Articulator Standard arcon yamahachi type Articulator with A ball slot type path on the maxillary frame

**QI-12-003**

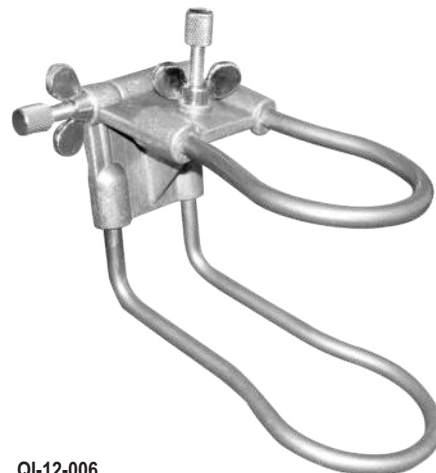
Semi anatomical silver Articulator high tech. Adjustable back rod by registration screw to work without incisal rod by keeping constant trajectories and inclinations during side and back/forward movements. Pure translation movement anti-shock hinge rod in case Articulator falls accidentally. Bigger size lock screws for mounting plates

**QI-12-004**

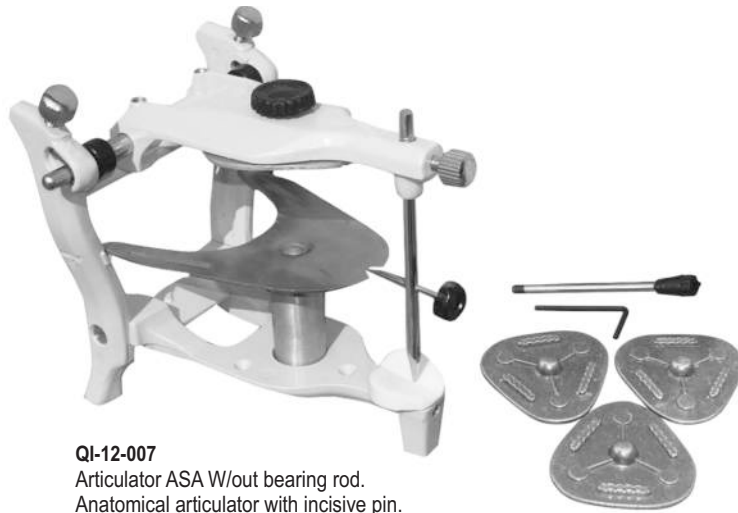
Gnatus Pro Jp30 Articulator best performance with an excellent degree of accuracy. Its functionality makes easier both the procedures of taking & transferring the patient's records & the process of mounting the models

**QI-12-005**

Magic Art-II Articulator high tech. Adjustable back lightweight, high-quality magic Art Articulator securely holds quadrant models, conserve materials & time! Quickly & Easily mouth pre-cast dental models with the high quality

**QI-12-006**

Vibratory polished wire Articulator - Made of stainless steel & die cast aluminum



**QI-12-007**  
Articulator ASA W/out bearing rod.  
Anatomical articulator with incisive pin.  
4 mounting plates and Supporting back pin.  
Available in assorted colors



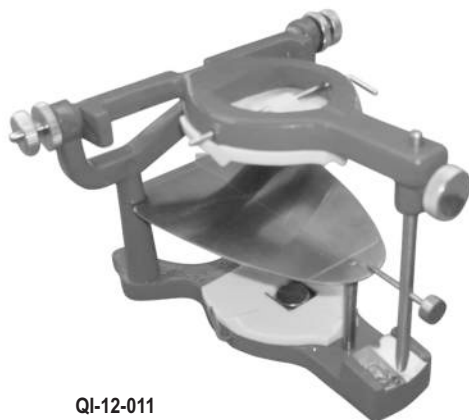
**QI-12-008**  
ASA Articulator with lateral moment.  
Made of aluminum die casting with  
2 Mounting Plates. Also Available in  
vibratory polished process & Assorted colors



**QI-12-009**  
Keystone deluxe magnetic denture  
articulator with plates, Interchangeable,  
Incisal pin Included. Magnetic Split Casting  
ensures Easy & Exact Setting, Lateral  
excursions



**QI-12-010**  
Keystone deluxe universal type-A Articulator.  
Interchangeable, Included Incisal pin, Lateral  
excursions



**QI-12-011**  
Anatomical Articulator Universal,  
Realized for easy visibility to the lingual surface  
& for A perfect stability Also In reserved position.  
(Also available in assorted colors)



**QI-12-012**  
Chromium plated fork  
Fork Crowned Bridge.  
Nickle chromium plated articulator

**QI-12-013**

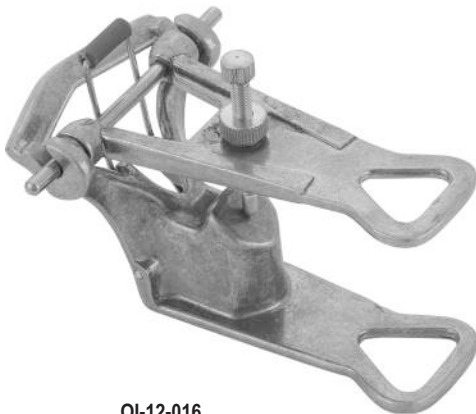
Full arch hinged articulator  
chromium plated hinge articulator  
for mounting full arch cases.  
Low back gypsum-free articulation enables  
clean & accurate mounting & dismounting  
in 30 seconds

**QI-12-014**

Ray foster 57 chrome articulator  
chrome brass hinge crowned bridge  
articulator for mounting quadrant cases.  
Crown & bridge articulator is popular ray  
foster # 57 design,  
eliminates the need to break off models

**QI-12-015**

Occlusor, wire articulator,  
Available in 2 sizes,  
Small & Large

**QI-12-016**

Professional occlusor.  
Vibratory polished articulator.

**QI-12-017**

Dental articulator 2x-cresant brand  
full denture chromium plated articulator.  
Provides additional vertical dimension for  
acceptance of higher models. 49 wide at  
the joint & has a vertical span between  
parallel bows of 25/8"

**QI-12-018**

Hinge articulator full arch  
plain line nickle chromium  
plated articulator

**QI-12-019**

Magic Art-I articulator lightweight

**QI-12-020**

Mortimer-I oculader articulator  
All filled with high carbon Steel balls.  
Also available in gold plated

**QI-12-021**

Mortimer-II oculader articulator  
Also available in gold plated


British Pattern




# DENTAL INSTRUMENTS Catalogue



**QUIRKY INSTRUMENTS**  
PREMIUM QUALITY INSTRUMENTS

 Shahab Pura Road, Sialkot - 51310 Pakistan.

 +92-341-4059033

 [info@quirkyinstruments.com](mailto:info@quirkyinstruments.com)

 [www.quirkyinstruments.com](http://www.quirkyinstruments.com)

